

# VEVOR®

TOUGH TOOLS, HALF PRICE

Support and E-Warranty Certificate <https://www.vevor.com/support>

We continue to be committed to provide you tools with competitive price. "Save Half", "Half Price" or any other similar expressions used by us only represents an estimate of savings you might benefit from buying certain tools with us compared to the major top brands and does not necessarily mean to cover all categories of tools offered by us. You are kindly reminded to verify carefully when you are placing an order with us if you are actually saving half in comparison with the top major brands.

## Workbench Instruction Manual

# VEVOR®

TOUGH TOOLS, HALF PRICE

## WORKBENCH

ET-24-18 / ETG-24-24 / ET-30-30

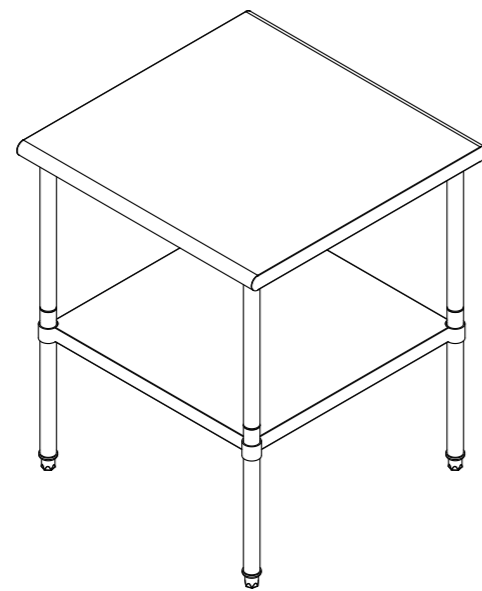

### NEED HELP? CONTACT US!

Have product questions? Need technical support?  
Please feel free to contact us:

[CustomerService@vevor.com](mailto:CustomerService@vevor.com)

This is the original instruction, please read all manual instructions carefully before operating. VEVOR reserves clear interpretation of our user manual. The appearance of the product shall be subject to the product you received. Please forgive us that we won't inform you again if there is any technology or software updates on our product.

01

### Product Parameters

Model	Thickness	Material	Dimension (L x W x H)
ET-24-18	0.8 mm	201 Stainless Steel	609.6×457.2×914.4 mm (24×18×36 inch)
ETG-24-24	0.8 mm	201 Stainless Steel	609.6×609.6×914.4 mm (24×24×36 inch)
ET-30-30	0.8 mm	201 Stainless Steel	762×762×914.4 mm (30×30×36 inch)

### Packing List

Item	Part Name	QTY	Picture
1	Panel	1 PCS	
2	Shelves	4 PCS	
3	Upper support tube	4 PCS	
4	Lower support tube	4 PCS	
5	Mounting sleeves	4 PCS	
6	Supporting feet	4 PCS	
7	M6 flat head bolts	5 PCS	
8	M8 tightening bolt	5 PCS	
9	hex key	1 PCS	
10	3-inch universal casters (2 with brakes) <b>Note: Only model ETG-24-24 has casters</b>	4 PCS	

02

# VEVOR®

TOUGH TOOLS, HALF PRICE

Support and E-Warranty Certificate <https://www.vevor.com/support>  
Made in China

After the installation is complete, adjust the height of the four support feet (or casters) to ensure that the four feet of the workbench are close to the ground and the table cannot be shaken.

### Precautions

#### Precautions:

Some models of workbenches are equipped with casters. After replacing the casters, if the workbench does not need to move, please step on the brakes on the casters to ensure that the workbench will not move when pushed.

Each workbench has a maximum weight limit, please be careful not to exceed the maximum weight when using it.

Address: Baoshanqu Shuangchenglu 803long 11hao 1602A-1609shi Shanghai  
Imported to AUS: SIHAO PTY LTD, 1 ROKEVA STREET EASTWOOD NSW 2122 Australia  
Imported to USA: Sanven Technology Ltd., Suite 250, 9166 Anaheim Place, Rancho Cucamonga, CA 91730

**EC REP** SHUNSHUN GmbH  
Römeracker 9 Z2021, 76351  
Linkenheim-Hochstetten, Germany

**UK REP** Pooledas Group Ltd  
Unit 5 Albert Edward House,  
The Pavilions Preston, United Kingdom

MADE IN CHINA

### Packing List

This is the original instruction, please read all manual instructions carefully before operating. VEVOR reserves clear interpretation of our user manual. The appearance of the product shall be subject to the product you received. Please forgive us that we won't inform you again if there is any technology or software updates on our product.

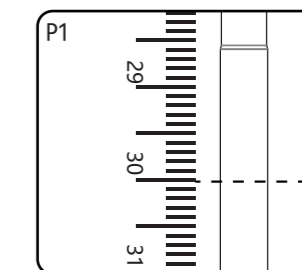

Use a ruler to measure the required height on the down round tube and mark it.

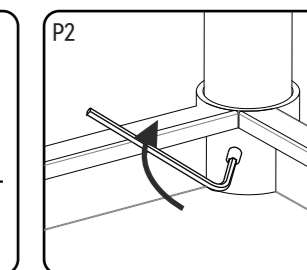

Install the divider according to the label and use the M8 setting bolt to set the torque at 25N·m or greater.

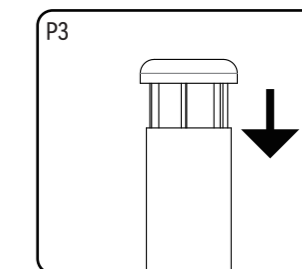

Take the mounting sleeve and press into the down round tube.

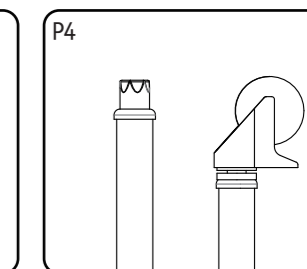

Install the feet (or casters)  
**Note: Only model ETG-24-24 has casters**

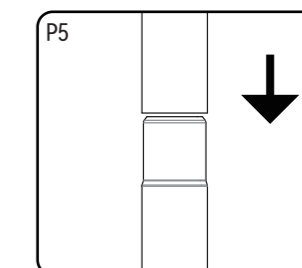

Place the product directly on the floor and put on the up round tube.

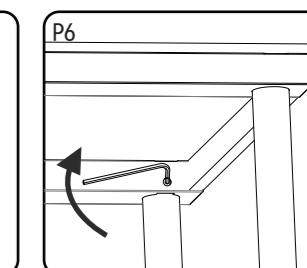

Install the panel to the hole and use M6 flat head bolts to fix the torque greater than or equal to 25N·m

03

**VEVOR**<sup>®</sup>  
TOUGH TOOLS, HALF PRICE

Wsparcie i certyfikat gwarancji elektronicznej <https://www.vevor.com/support>

Nadal staramy się dostarczać Ci narzędzia w konkurencyjnych cenach. „Zapisz połowę ceny”, „Połowa ceny” lub jakiegokolwiek inne podobne wyrażenia używane przez nas oznaczają wyłącznie szacunkowe oszczędności, jakie możesz uzyskać. Kupując u nas określone narzędzia, działy w porównaniu do głównych marek i dawek niekoniecznie oznacza to, że obejmują one wszystkie kategorie narzędzi oferowane przez nas. You are kindly reminded to ve...  
jeśli składasz u nas zamówienie, to faktycznie oszczędzisz połowę porównanie z wiodącymi markami.

Stół warsztatowy  
Instrukcja obsługi

**VEVOR**<sup>®</sup>  
TOUGH TOOLS, HALF PRICE

STÓŁ WARSZTATOWY

ET-24-18 / ETG-24-24 / ET-30-30

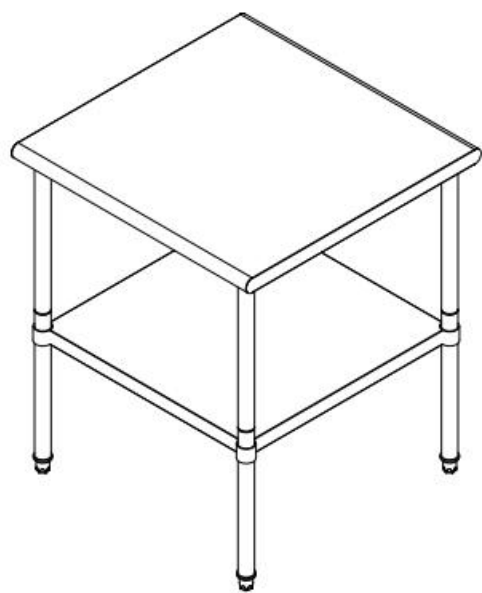

### NEED HELP? CONTACT US!

Have product questions? Need technical support?  
Please feel free to contact us:

[CustomerService@vevor.com](mailto:CustomerService@vevor.com)

This is the original instruction. Please read all manual instructions carefully before operating. VEVOR reserves clear interpretation of our user manual. The appearance of the product shall be subject to the product you received. Please forgive us that we won't inform you again if there is any technology or software updates on our product.

01

### Parametry produktu

Model	Grubość	Tworzywo	Wymiar (Dł. x szer. x wys.)
ET-24-18	0,8 mm	201 Stal nierdzewna	609,6×457,2×914,4 mm (24×18×36 cali)
ETG-24-24	0,8 mm	201 Stal nierdzewna	609,6×609,6×914,4 mm (24×24×36 cali)
ET-30-30	0,8 mm	201 Stal nierdzewna	Wymiary 762×762×914,4 mm (30×30×36 cali)

### Lista rzeczy do spakowania

Przedmiot	Part Name	ILOŚĆ	Zdjęcie
1	Płyta	1 szt.	
2	Półki	4 szt.	
3	Upper support tube	4 szt.	
4	Lower support tube	4 szt.	
5	Tuleje montażowe	4 szt.	
6	Supporting feet	4 szt.	
7	M6 flat head bolts	5 SZT.	
8	Śruba dociskowa M8	5 SZT.	
9	Klucz imbusowy	1 szt.	
10	3-calowe uniwersalne kółka (2 z hamulcami) Uwaga: Tylko model ETG-24-24 posiada kółka	4 szt.	

02

**VEVOR**<sup>®</sup>  
TOUGH TOOLS, HALF PRICE

Wsparcie i certyfikat gwarancji elektronicznej <https://www.vevor.com/support>  
Wyrobowano w Chinach

Po zakończeniu instalacji należy wyregulować wysokość czterech support feet (or casters) to ensure that the four feet of the Stół roboczy znajduje się blisko podłoża, co zapobiega jego przemieszczaniu się.

### Środki ostrożności

Środki ostrożności:

-Niektóre modele stołów roboczych są wyposażone w kółka. Po wymiana kółek, jeśli nie ma potrzeby przesuwania stołu roboczego, proszę nacisnąć hamulce na kółkach, aby mieć pewność, że stół warsztatowy nie będzie się przesuwał po podłożu.

-Każdy stół warsztatowy ma limit maksymalnego obciążenia, należy zachować ostrożność, aby nie przekroczyć przekraczać maksymalnego ciężaru podczas jego użytkowania.

Adres: Baoshanqu Shuangchenglu 803long 11hao 1602A-1609shi Szanghaj  
Imported to AUS: SIHAO PTY LTD, 1 ROKEVA STREET EASTWOOD NSW 2122 Australia  
Imported to USA: Sanven Technology Ltd., Suite 250, 9166 Anaheim Place, Rancho Cucamonga, Kalifornia 91730

Przedstawiciel UE  
SHUNSHUN GmbH  
Rzymaska 9 ZZ021, 76351  
Linkenheim-Hochstetten, Niemcy

REP WIELKIEJ BRYTANII  
Grupa Pooledas Ltd.  
Unit 5 Albert Edward House,  
Pawilony Preston, Wielka Brytania

WYKONANO W CHINACH

### Lista rzeczy do spakowania

To jest oryginalna instrukcja, proszę przeczytać wszystkie instrukcje w podręczniku carefully before operating. VEVOR reserves clear interpretation of nasza instrukcja obsługi.

Wygląd produktu będzie zależał od produktu, który otrzymałeś.

Przepraszamy, ale nie będziemy Cię już więcej informować, jeśli w naszym produkcie pojawią się aktualizacje technologiczne lub oprogramowania.

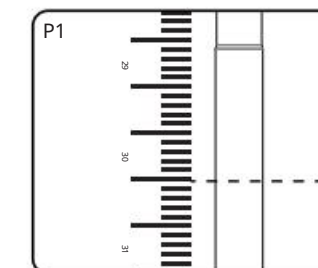

Za pomocą liniiki zmierz potrzebną wysokość dolnej okrągłej rury i zaznacz ją.

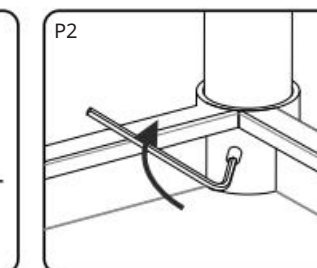

Zamontuj rozdzielnice zgodnie z etykietą i za pomocą śruby regulacyjnej M8 ustaw moment dokręcania na 25 N·m lub więcej.

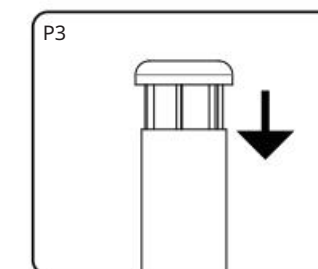

Włóż tuleję montażową i wcisnij ją w dolną okrągłą rurkę.

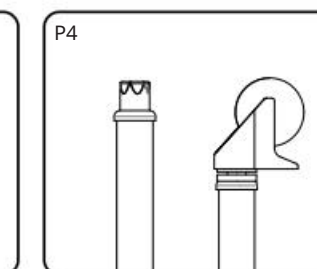

Zamontuj nóżki (lub kółka)  
Uwaga: Tylko model ETG-24-24 posiada kółka

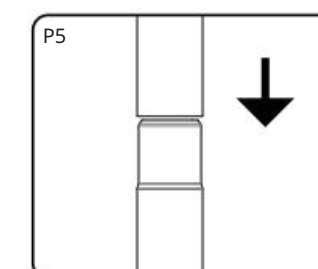

Umieść produkt bezpośrednio na podłodze i nałóż na niego ciężar.

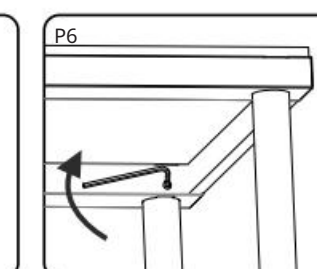

Zamontuj panel w otworze i użyj M6 flat head bolts to fix the torque więk. ksy lub równy 25 N·m

03

**VEVOR**<sup>®</sup>  
TOUGH TOOLS, HALF PRICE

Support und E-Garantie-Zertifikat <https://www.vevor.com/support>

Wir sind weiterhin bestrebt, Ihnen Werkzeuge zu wettbewerbsfähigen Preisen anzubieten. "Speichern Halb", "Halber Preis" oder andere ähnliche Ausdrücke, die wir verwenden, bedeuten nur eine Schätzung der Einsparungen, die Sie erzielen könnten, wenn Sie bestimmte Werkzeuge bei uns kaufen im Vergleich zu den wichtigsten Top-Marken und Dosen bedeuten nicht unbedingt, alle categories of tools offered by us. You are kindly reminded to ve...  
wenn Sie eine Bestellung bei uns aufgeben, wenn Sie tatsächlich die Hälfte sparen in Vergleich mit den Top-Großmarken.

## Werkbank Bedienungsanleitung

**VEVOR**<sup>®</sup>  
TOUGH TOOLS, HALF PRICE

WERKBANK

ET-24-18 / ETG-24-24 / ET-30-30

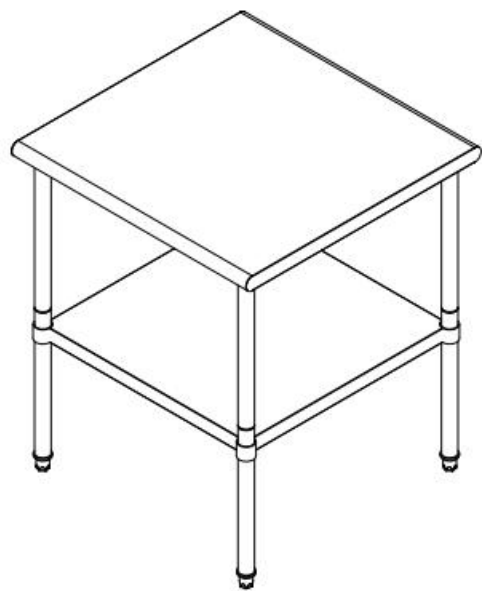

### NEED HELP? CONTACT US!

Have product questions? Need technical support?  
Please feel free to contact us:

[CustomerService@vevor.com](mailto:CustomerService@vevor.com)

This is the original instruction, Please read all manual instructions carefully before operating. VEVOR reserves clear interpretation of our user manual. The appearance of the product shall be subject to the product you received. Please forgive us that we won't inform you again if there is any technology or software updates on our product.

01

### Produktparameter

Modell	Dicke	Material	Dimension (L x B x H)
ET-24-18	0,8 mm	201 Edelstahl	609,6x457,2x914,4 mm (24x18x36 Zoll)
ETG-24-24	0,8 mm	201 Edelstahl	609,6x609,6x914,4 mm (24x24x36 Zoll)
ET-30-30	0,8 mm	201 Edelstahl	762x762x914,4 mm (30x30x36 Zoll)

### Packliste

Artikel	Part Name	Menge	Bild
1	Bodenblech	1 STK	
2	Regale	4 Stück	
3	Upper support tube	4 Stück	
4	Lower support tube	4 Stück	
5	Montagehülsen	4 Stück	
6	Supporting feet	4 Stück	
7	M6 flat head bolts	5 STK	
8	M8 Spannschraube	5 STK	
9	Inbusschlüssel	1 STK	
10	3-Zoll-Universalrollen (2 mit Bremse) Hinweis: Nur das Modell ETG-24-24 verfügt über Rollen	4 Stück	

02

**VEVOR**<sup>®</sup>  
TOUGH TOOLS, HALF PRICE

Support und E-Garantie-Zertifikat <https://www.vevor.com/support>  
In China hergestellt

Nach Abschluss der Installation stellen Sie die Höhe der vier support feet(or casters)to ensure that the four feet of the Die Werkbank steht nah am Boden und der Tisch kann nicht erschüttert werden.

### Vorsichtsmaßnahmen

Vorsichtsmaßnahmen:

-Einige Modelle von Werkbänken sind mit Rollen ausgestattet. Nach Austausch der Rollen, wenn die Werkbank nicht bewegt werden muss, Bitte treten Sie auf die Bremsen der Rollen, um sicherzustellen, dass das Die Werkbank bewegt sich nicht, wenn man sie schubst.

-Jede Werkbank hat eine maximale Gewichtsgrenze. Bitte achten Sie darauf, nicht das Maximalgewicht bei der Benutzung zu überschreiten.

Adresse: Baoshanqu Shuangchenglu 803long 11hao 1602A-1609shi  
Shanghai  
Imported to AUS: SIHAO PTY LTD, 1 ROKEVA STREETEASTWOOD NSW  
2122 Australien  
Imported to USA: Sanven Technology Ltd., Suite 250, 9166 Anaheim Place,  
Rancho Cucamonga, Kalifornien 91730

**Vertreter der EG**  
SHUNSHUN GmbH  
Römeracker 9 Z2021, 76351  
Linkenheim-Hochstetten, Deutschland

**UK REP**  
Pooledas Group Ltd  
Unit 5 Albert Edward House,  
The Pavilions Preston, Vereinigtes Königreich

IN CHINA HERGESTELLT

### Packliste

Dies ist die Originalanleitung. Bitte lesen Sie alle Anweisungen im Handbuch, carefully before operating. VEVOR reserves clear interpretation of unser Benutzerhandbuch.

Das Aussehen des Produkts richtet sich nach dem Produkt, das Sie erhalten haben.

Bitte haben Sie Verständnis, dass wir Sie bei Technologie- oder Software-Updates zu unserem Produkt nicht zusätzlich informieren.

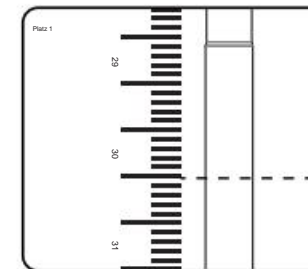

Messen Sie mit einem Lineal die gewünschte Höhe am unteren Rundrohr ab und markieren Sie diese.

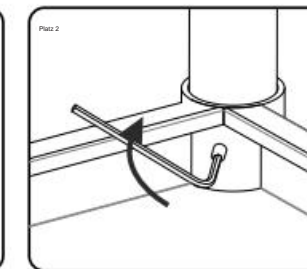

Installieren Sie die Trennwand gemäß der Etikett und verwenden Sie die M8-Einstellschraube, um das Drehmoment auf 25 Nm oder mehr einzustellen.

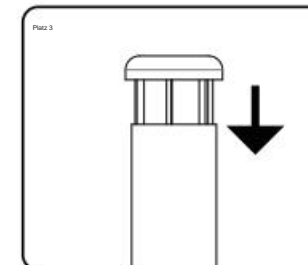

Nehmen Sie die Montagehülse und drücken Sie diese in das untere Rundrohr.

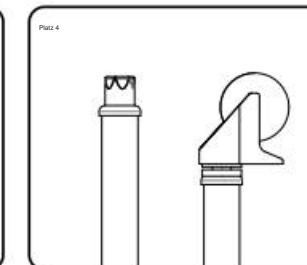

Installieren Sie die Füße (oder Rollen).  
Hinweis: Nur das Modell ETG-24-24 verfügt über Rollen

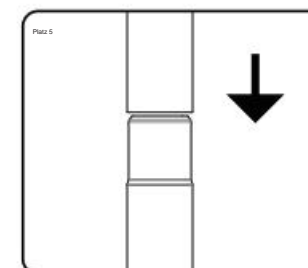

Platzieren Sie das Produkt direkt auf dem floor and put on the up round tube.

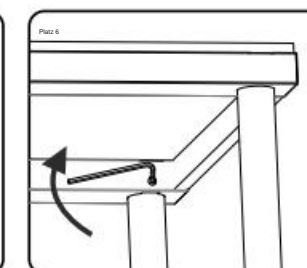

Montieren Sie das Panel in der Öffnung und verwenden Sie M6 flat head bolts to fix the torque größer oder gleich 25N-m

03

**VEVOR**<sup>®</sup>  
TOUGH TOOLS, HALF PRICE

Certificat d'assistance et de garantie électronique <https://www.vevor.com/support>

Nous continuons à nous engager à vous fournir des outils à des prix compétitifs. "Enregistrer Moitié", "Moitié Prix" ou toute autre expression similaire utilisée par nous ne représente que une estimation des économies que vous pourriez réaliser en achetant certains outils chez nous par rapport aux grandes marques et les doses ne visent pas nécessairement à couvrir tous les *categories of tools offered by us. You are kindly reminded to ve* lorsque vous passez une commande chez nous, si vous économisez réellement la moitié comparaison avec les plus grandes marques.

Établi  
Manuel d'instructions

**VEVOR**<sup>®</sup>  
TOUGH TOOLS, HALF PRICE

ÉTABLISSEMENT

ET-24-18 / ETG-24-24 / ET-30-30

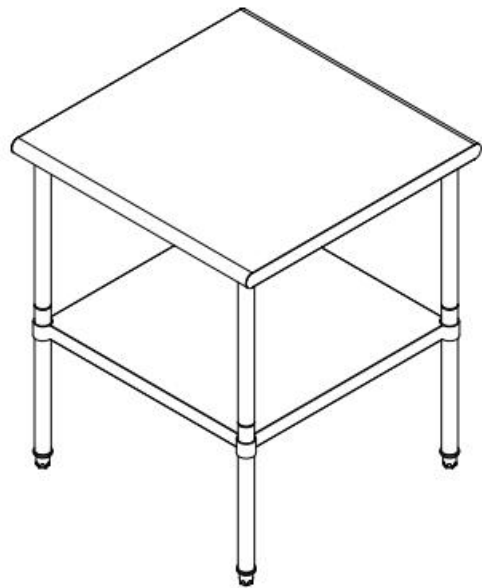

### NEED HELP? CONTACT US!

Have product questions? Need technical support?  
Please feel free to contact us:

 [CustomerService@vevor.com](mailto:CustomerService@vevor.com)









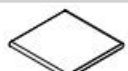

This is the original instruction, Please read all manual instructions carefully before operating. VEVOR reserves clear interpretation of our user manual. The appearance of the product shall be subject to the product you received. Please forgive us that we won't inform you again if there is any technology or software updates on our product.

01

### Paramètres du produit

Modèle	Épaisseur	Matériel	Dimension (L x l x H)
ET-24-18	0,8 mm	Acier inoxydable 201	609,6 × 457,2 × 914,4 mm (24 × 18 × 36 pouces)
ETG-24-24	0,8 mm	Acier inoxydable 201	609,6 × 609,6 × 914,4 mm (24 × 24 × 36 pouces)
ET-30-30	0,8 mm	Acier inoxydable 201	762 × 762 × 914,4 mm (30 × 30 × 36 pouces)

### Liste de colisage

Article	Part Name	Qté	Image
1	Panneau	1 pièce	
2	Étagères	4 pièces	
3	Upper support tube	4 pièces	
4	Lower support tube	4 pièces	
5	Manchons de montage	4 pièces	
6	Supporting feet	4 pièces	
7	M6 flat head bolts	5 pièces	
8	Boulon de serrage M6	5 pièces	
9	clé hexagonale	1 pièce	
10	Roulettes universelles de 3 pouces (2 avec freins) Remarque : seul le modèle ETG-24-24 est équipé de roulettes	4 pièces	

02

Une fois l'installation terminée, ajustez la hauteur des quatre support feet (or casters) to ensure that the four feet of the établi est proche du sol et la table ne peut pas être secouée.

### Précautions

Précautions:

Certains modèles d'établis sont équipés de roulettes. Après remplacement des roulettes, si l'établi n'a pas besoin d'être déplacé, veuillez appuyer sur les freins des roulettes pour vous assurer que le établi ne bouge pas lorsqu'on le pousse.

Chaque établi a une limite de poids maximale, veuillez faire attention à ne pas de dépasser le poids maximum lors de son utilisation.

Adresse : Baoshanqu Shuangchenglu 803long 11hao 1602A-1609shi Shanghai  
Imported to AUS: SIHAO PTY LTD, 1 ROKEVA STREET EASTWOOD NSW 2122 Australie  
Imported to USA: Sanven Technology Ltd., Suite 250, 9166 Anaheim Place, Rancho Cucamonga, California 91730

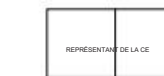
 SHUNSHUN GmbH  
Römeracker 9 Z2021, 76351  
Linkenheim-Hochstetten, Allemagne

 Groupe Pooledas Ltd  
Unit 5 Albert Edward House,  
Les Pavillons Preston, Royaume-Uni

FABRIQUÉ EN CHINE

**VEVOR**<sup>®</sup>  
TOUGH TOOLS, HALF PRICE

Certificat d'assistance et de garantie électronique <https://www.vevor.com/support>  
Fabriqué en Chine

### Liste de colisage

Ceci est l'instruction originale, veuillez lire toutes les instructions du manuel *carefully before operating*. VEVOR reserves clear interpretation of notre manuel d'utilisation.

L'apparence du produit dépend du produit que vous avez reçu.

Veuillez nous excuser, nous ne vous informerons plus s'il y a des mises à jour technologiques ou logicielles sur notre produit.

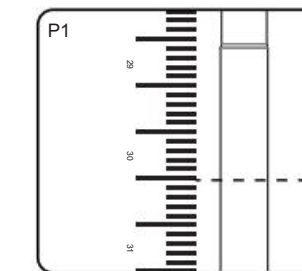

Utilisez une règle pour mesurer la hauteur requise sur le tube rond descendant et marquez-la.

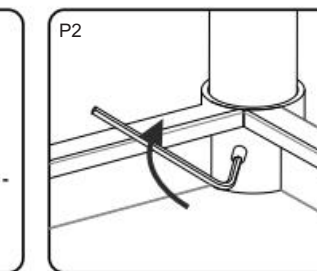

Installez le séparateur selon les étiquettes et utilisez le boulon de réglage M8 pour régler le couple à 25 N·m ou plus.

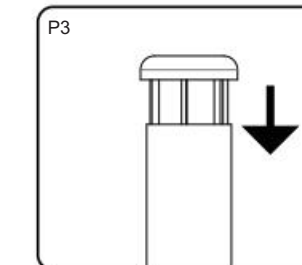

Prenez le manchon de montage et appuyez-le dans le tube rond descendant.

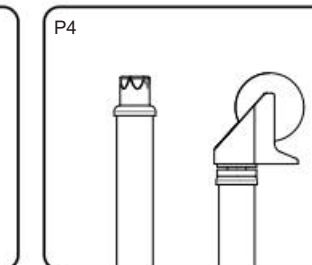

Installez les pieds (ou roulettes)

Remarque : seul le modèle ETG-24-24 est équipé de roulettes

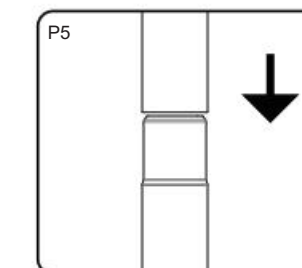

Placer le produit directement sur le floor and put on the up round tube.

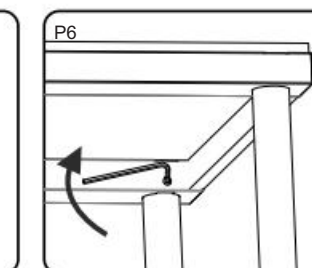

Installez le panneau dans le trou et utilisez M6 flat head bolts to fix the torque supérieure ou égal à 25 N·m

03

**VEVOR**<sup>®</sup>  
TOUGH TOOLS, HALF PRICE

Ondersteuning en E-garantiecertificaat <https://www.vevor.com/support>

Wij blijven ons inzetten om u gereedschappen te leveren tegen concurrerende prijzen. "Beespaar Half", "Halve prijs" of andere soortgelijke uitdrukkingen die wij gebruiken, vertegenwoordigen alleen een schatting van de besparingen die u kunt behalen door bepaalde gereedschappen bij ons te kopen vergeleken met de grote topmerken en doseringen betekent niet noodzakelijkerwijs dat ze alles dekken *categories of tools offered by us. You are kindly reminded to ve* comparing ourselves wanneer u een bestelling bij ons plaatst, als u daadwerkelijk de helft bespaart vergelijking met de grootste topmerken.

**Werkbank**  
**Gebruiksaanwijzing**

**VEVOR**<sup>®</sup>  
TOUGH TOOLS, HALF PRICE

**WERKBANK**

ET-24-18 / ETG-24-24 / ET-30-30

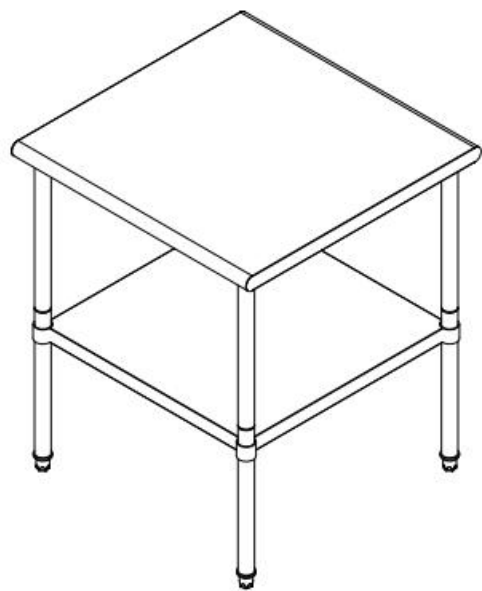

### NEED HELP? CONTACT US!

Have product questions? Need technical support?  
Please feel free to contact us:

 [CustomerService@vevor.com](mailto:CustomerService@vevor.com)







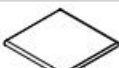

This is the original instruction, Please read all manual instructions carefully before operating. VEVOR reserves clear interpretation of our user manual. The appearance of the product shall be subject to the product you received. Please forgive us that we won't inform you again if there is any technology or software updates on our product.

01

### Productparameters

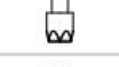
Model	Dikte	Materiaal	Dimensie (L x B x H)
ET-24-18	0,8mm	201 roestvrij staal	609,6x457,2x914,4mm (24x18x36 inch)
ETG-24-24	0,8mm	201 roestvrij staal	609,6x609,6x914,4mm (24x24x36 inch)
ET-30-30	0,8mm	201 roestvrij staal	762x762x914,4 mm (30x30x36 inch)

### Paklijst

Item	Part Name	Hoeveelheid	Afbeelding
1	Paneel	1 STUKS	
2	Planken	4 STUKS	
3	Upper support tube	4 STUKS	
4	Lower support tube	4 STUKS	
5	Montagehulzen	4 STUKS	
6	Supporting feet	4 STUKS	
7	M6 flat head bolts	5 STUKS	
8	M8 spanbout	5 STUKS	
9	inbusleutel	1 STUKS	
10	Universele wielen van 3 inch (2 met remmen) Let op: Alleen model ETG-24-24 heeft wielen	4 STUKS	

02

**VEVOR**<sup>®</sup>  
TOUGH TOOLS, HALF PRICE

Ondersteuning en E-garantiecertificaat <https://www.vevor.com/support>  
Gemaakt in China

Nadat de installatie is voltooid, past u de hoogte van de vier aan support feet (or casters) to ensure that the four feet of the workbenks staan dicht bij de grond en de tafel kan niet geschud worden.

### Voorzorgsmaatregelen

Voorzorgsmaatregelen:

-Sommige modellen werkbanken zijn uitgerust met wielen. Na het vervangen van de wielen, als de werkbank niet verplaatst hoeft te worden, Trap op de remmen van de wielen om ervoor te zorgen dat de Werkbank beweegt niet als er tegenaan wordt geduwd.

-Elke werkbank heeft een maximumgewicht. Wees voorzichtig en voorkom dat om het maximale gewicht te overschrijden bij gebruik.

Adres: Baoshanqu Shuangchenglu 803long 11hao 1602A-1609shi Sjanghai  
Imported to AUS: SIHAO PTY LTD, 1 ROKEVA STREET EASTWOOD NSW 2122 Australië  
Imported to USA: Sanven Technology Ltd., Suite 250, 9166 Anaheim Place, Rancho Cucamonga, CA 91730

**EC-REP** SHUNSHUN GmbH  
Romeräcker 9 Z2021, 76351  
Linkenheim-Hochstetten, Duitsland

**VK REP** Pooledas Groep Ltd  
Unit 5 Albert Edward House,  
The Pavilions Preston, Verenigd Koninkrijk

Gemaakt in China

### Paklijst

Dit is de originele instructie. lees alle instructies in de handleiding carefully before operating. VEVOR reserves clear interpretation of onze gebruikershandleiding.

Het uiterlijk van het product is afhankelijk van het product dat u heeft ontvangen.

Wij vragen u om uw excuses, want wij informeren u niet meer als er technologische of software-updates voor ons product beschikbaar zijn.

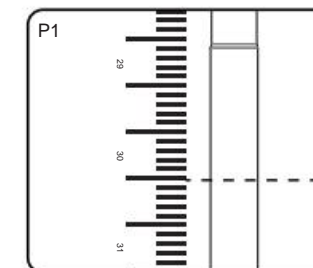

Meet met een liniaal de gewenste hoogte op de ronde buis en markeer deze.

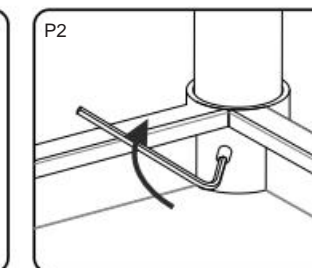

Installeer de verdeler volgens de label en gebruik de M8-instelbout om het koppel in te stellen op 25 N-m of hoger.

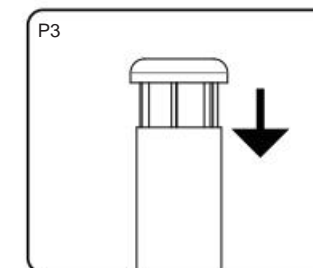

Neem de montagehuls en druk deze in de ronde buis.

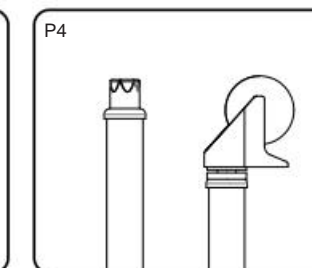

Installeer de poten (of wieljes)  
Let op: Alleen model ETG-24-24 heeft wielen

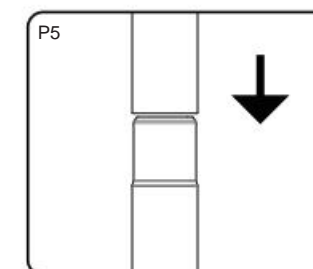

Plaats het product direct op de floor and put on the up round tube.

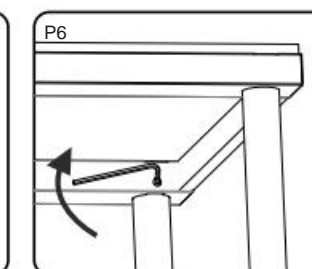

Installeer het paneel in het gat en gebruik M6 flat head bolts to fix the torque groter dan of gelijk aan 25N-m

03

**VEVOR**<sup>®</sup>  
TOUGH TOOLS, HALF PRICE

Support och e-garanticertifikat <https://www.vevor.com/support>

Vi fortsätter att vara engagerade i att ge dig verktyg till konkurrenskraftiga priser. "Spara Halva, "Halva priset" eller andra liknande uttryck som används av oss representerar endast en uppskattning av besparingar du kan dra nytta av att köpa vissa verktyg hos oss jämfört med de stora toppmärkena och doserna betyder inte nödvändigtvis att täcka alla *categories of tools offered by us. You are kindly reminded to verify* försiktigt när du lägger en beställning hos oss om du faktiskt sparar hållten jämförelse med de främsta varumärkena.

## Arbetsbänk Instruktionsmanual

**VEVOR**<sup>®</sup>  
TOUGH TOOLS, HALF PRICE

ARBETSBÄNK

ET-24-18 / ETG-24-24 / ET-30-30

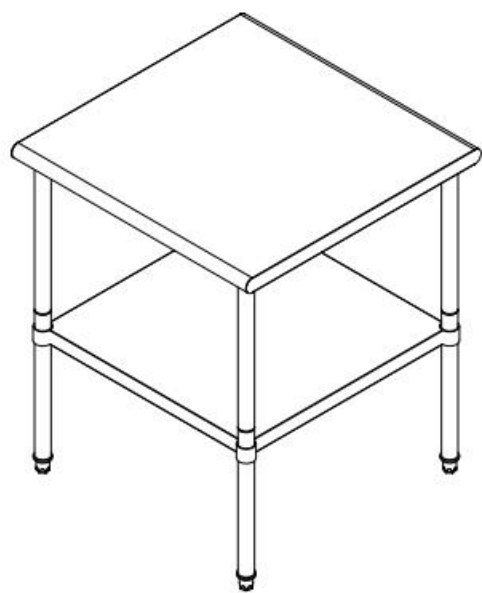

### NEED HELP? CONTACT US!

Have product questions? Need technical support?  
Please feel free to contact us:

 [CustomerService@vevor.com](mailto:CustomerService@vevor.com)









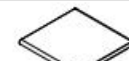

This is the original instruction, Please read all manual instructions carefully before operating. VEVOR reserves clear interpretation of our user manual. The appearance of the product shall be subject to the product you received. Please forgive us that we won't inform you again if there is any technology or software updates on our product.

01

### Produktparametrar

Modell	Tjocklek	Material	Dimensionera (L x B x H)
ET-24-18	0,8 mm	201 rostfritt stål	609,6x457,2x914,4 mm (24x18x36 tum)
ETG-24-24	0,8 mm	201 rostfritt stål	609,6x609,6x914,4 mm (24x24x36 tum)
ET-30-30	0,8 mm	201 rostfritt stål	762x762x914,4 mm (30x30x36 tum)

### Packlista

Punkt	Part Name	ANTAL	Bild
1	Panel	1 st	
2	Hyllor	4 st	
3	Upper support tube	4 st	
4	Lower support tube	4 st	
5	Monteringshylsor	4 st	
6	Supporting feet	4 st	
7	M6 flat head bolts	5 st	
8	M8 spännbult	5 st	
9	Åsökningsnyckel	1 st	
10	3-tums universelhjul (2 med bromsar) Obs: Endast modell ETG-24-24 har hjul	4 st	

02

När installationen är klar, justera höjden på de fyra support feet (or casters) to ensure that the four feet of the arbetsbänken är nära marken och bordet kan inte skakas.

### Försiktighetsåtgärder

Försiktighetsåtgärder:

-Vissa modeller av arbetsbänkar är utrustade med hjul. Efter byte av hjulen, om arbetsbänken inte behöver flytta, trampa på bromsarna på hjulen för att säkerställa att arbetsbänken rör sig inte när den trycks ned.

-Varje arbetsbänk har en maxviktsgräns, var försiktig med att inte att överskrida maxvikten när du använder den.

Adress: Baoshanqu Shuangchenglu 803long 11hao 1602A-1609shi Shanghai  
Imported to AUS: SIHAO PTY LTD, 1 ROKEVA STREET EASTWOOD NSW 2122 Australien  
Imported to USA: Sanven Technology Ltd., Suite 250, 9166 Anaheim Place, Rancho Cucamonga, CA 91730

**EC REP** SHUNSHUN GmbH  
Römeracker 9 Z2021, 76351  
Linkenheim-Hochstetten, Tyskland

**UK REP** Pooledas Group Ltd  
Unit 5 Albert Edward House,  
The Pavilions Preston, Storbritannien

GJORT I KINA

**VEVOR**<sup>®</sup>  
TOUGH TOOLS, HALF PRICE

Support och e-garanticertifikat <https://www.vevor.com/support>  
Tillverkad i Kina

### Packlista

Detta är den ursprungliga instruktionen, läs alla manualer *carefully before operating*. VEVOR reserves clear interpretation of vår bruksanvisning.

Utseendet på produkten är beroende av den produkt du fått.

Ursäkt oss att vi inte kommer att informera dig igen om det finns någon teknik eller mjukvaruuppdateringar på vår produkt.

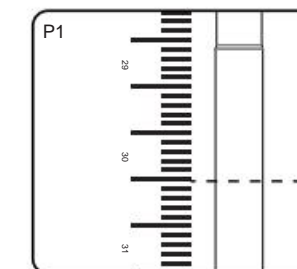

Använd en linjal för att mäta önskad höjd på det nedre runda röret och markera det.

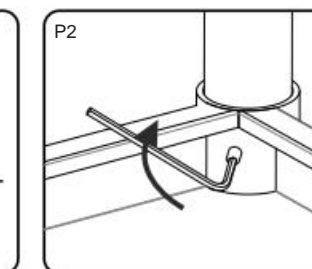

Installera avdelaren enligt etikett och använd M8-inställningsbulten för att ställa in vridmomentet på 25N-m eller mer.

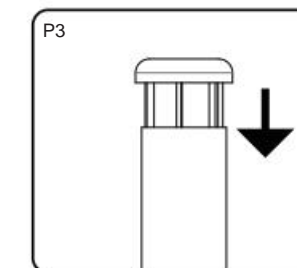

Ta monteringshylsan och tryck in i det nedre runda röret.

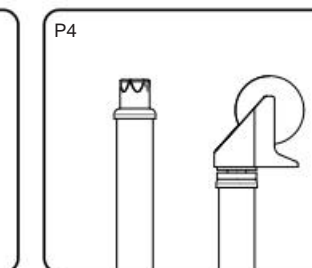

Montera fötterna (eller hjulen)  
Obs: Endast modell ETG-24-24 har hjul

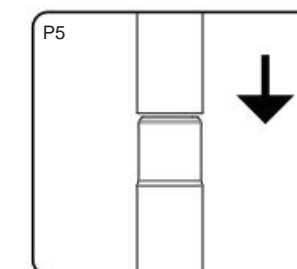

Placera produkten direkt på floor and put on the up round tube.

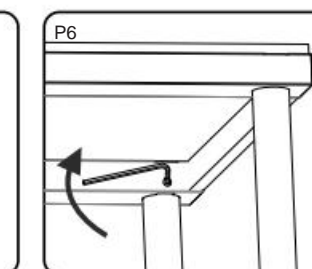

Montera panelen i hålet och använd den M6 flat head bolts to fix the torque större än eller lika med 25N-m

03

**VEVOR**<sup>®</sup>  
TOUGH TOOLS, HALF PRICE

Supporto e certificato di garanzia elettronica <https://www.vevor.com/support>

Continuiamo a impegnarci per fornirvi strumenti a prezzi competitivi. "Risparmia Metà", "Metà prezzo" o qualsiasi altra espressione simile da noi utilizzata rappresenta solo una stima dei risparmi che potresti ottenere acquistando determinati strumenti con noi rispetto ai principali marchi e le dosi non significano necessariamente coprire tutti *categories of tools offered by us. You are kindly reminded to ve* quando effettui un ordine con noi se stai effettivamente risparmiando la metà confronto con i principali marchi.

Banco da lavoro  
Manuale di istruzioni

**VEVOR**<sup>®</sup>  
TOUGH TOOLS, HALF PRICE

BANCO DA LAVORO

ET-24-18 / ETG-24-24 / ET-30-30

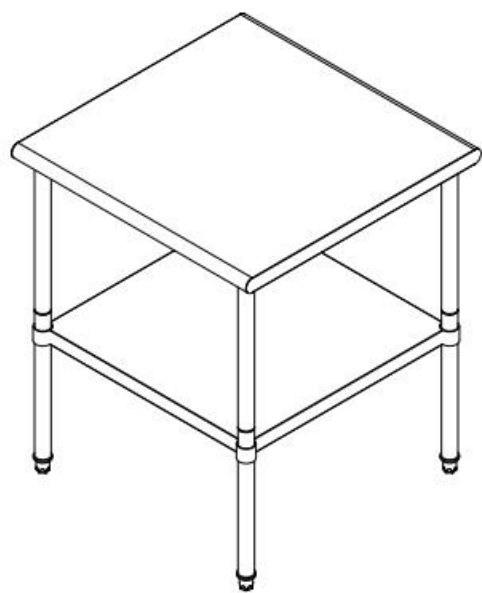

### NEED HELP? CONTACT US!

Have product questions? Need technical support?  
Please feel free to contact us:

 [CustomerService@vevor.com](mailto:CustomerService@vevor.com)







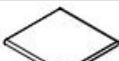
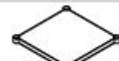

This is the original instruction, Please read all manual instructions carefully before operating. VEVOR reserves clear interpretation of our user manual. The appearance of the product shall be subject to the product you received. Please forgive us that we won't inform you again if there is any technology or software updates on our product.

01

### Parametri del prodotto

Modello	Spessore	Materiale	Dimensione (L x P x A)
ET-24-18	0,8 millimetri	Acciaio inossidabile 201	Dimensioni: 609,6x457,2x914,4 millimetri (24x18x36 pollici)
ETG-24-24	0,8 millimetri	Acciaio inossidabile 201	Dimensioni: 609,6x609,6x914,4 millimetri (24x24x36 pollici)
ET-30-30	0,8 millimetri	Acciaio inossidabile 201	Dimensioni: 762x762x914,4 millimetri (30x30x36 pollici)

### Lista imballaggio

Articolo	Part Name	Quantità	Immagine
1	Pannello	1 PZ	
2	Scaffali	4 PZ	
3	Upper support tube	4 PZ	
4	Lower support tube	4 PZ	
5	Manicotti di montaggio	4 PZ	
6	Supporting feet	4 PZ	
7	M6 flat head bolts	5 PZ	
8	Bullone di serraggio M8	5 PZ	
9	chiave esagona	1 PZ	
10	Ruote universali da 3 pollici (2 con freni) Nota: solo il modello ETG-24-24 ha le rotelle	4 PZ	

02

**VEVOR**<sup>®</sup>  
TOUGH TOOLS, HALF PRICE

Supporto e certificato di garanzia elettronica <https://www.vevor.com/support>  
Made in China

Dopo aver completato l'installazione, regolare l'altezza dei quattro support feet (or casters) to ensure that the four feet of the il banco da lavoro è vicino al suolo e il tavolo non può essere scosso.

### Precauzioni

#### Precauzioni:

-Alcuni modelli di banchi da lavoro sono dotati di rotelle. Dopo sostituzione delle rotelle, se il banco da lavoro non ha bisogno di muoversi, si prega di premere i freni sulle rotelle per assicurarsi che il banco da lavoro non si muove se spinto.

-Ogni banco da lavoro ha un limite massimo di peso, fare attenzione a non superare il peso massimo consentito durante l'utilizzo.

Indirizzo: Baoshanqu Shuangchenglu 803long 11hao 1602A-1609shi  
Sciangai  
Imported to AUS: SIHAO PTY LTD, 1 ROKEVA STREET EASTWOOD NSW 2122 Australia  
Imported to USA: Sanven Technology Ltd., Suite 250, 9166 Anaheim Place, Rancho Cucamonga, CA 91730

 Azienda  
Via Roma 9 Z2021, 76351  
Linkenheim-Hochstetten, Germania

 Gruppo Pooledas Ltd  
Unit 5 Albert Edward House,  
The Pavilions Preston, Regno Unito

MADE IN CHINA

### Lista imballaggio

Questa è l'istruzione originale, si prega di leggere tutte le istruzioni del manuale *carefully before operating*. VEVOR reserves clear interpretation of il nostro manuale utente.

L'aspetto del prodotto dipenderà dal prodotto ricevuto.

Vi preghiamo di scusarci se non vi informeremo più se ci saranno aggiornamenti tecnologici o software sul nostro prodotto.

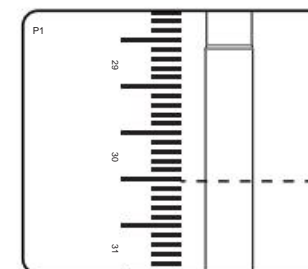

Utilizzare un righello per misurare l'altezza richiesta sul tubo tondo inferiore e contrassegnarla.

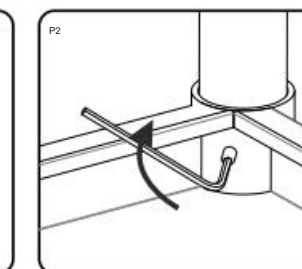

Installare il divisore secondo la etichetta e utilizzare il bullone di regolazione M8 per impostare la coppia a 25 N-m o superiore.

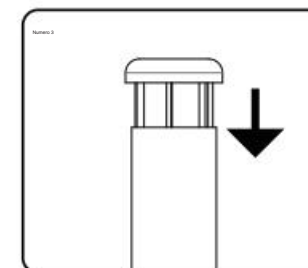

Prendere il manicotto di montaggio e premerlo nel tubo tondo inferiore.

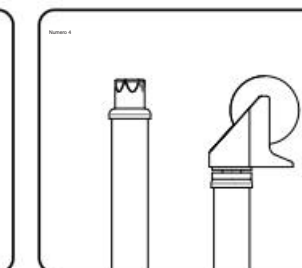

Installare i piedini (o le rotelle)  
Nota: solo il modello ETG-24-24 ha le rotelle

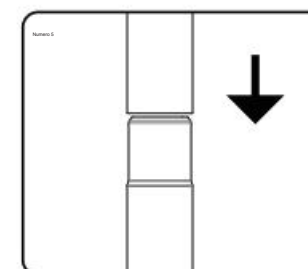

Posizionare il prodotto direttamente sul floor and put on the up round tube.

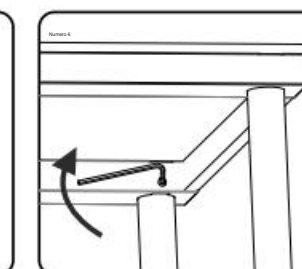

Installare il pannello nel foro e utilizzare M6 flat head bolts to fix the torque maggiore o uguale a 25N-m

03

**VEVOR**<sup>®</sup>  
TOUGH TOOLS, HALF PRICE

Certificado de soporte y garantía electrónica <https://www.vevor.com/support>

Seguimos comprometidos a brindarle herramientas a precios competitivos. \*Ahorre

La mitad, la mitad del precio o cualquier otra expresión similar utilizada por nosotros solo representa

Una estimación de los ahorros que podría obtener al comprar ciertas herramientas con nosotros

En comparación con las principales marcas y dosis superiores, no necesariamente significa cubrir todo.

categories of tools offered by us. You are kindly reminded to verify with cuidado

Cuando realiza un pedido con nosotros, si en realidad está ahorrando la mitad

Comparación con las principales marcas líderes.

Banco de trabajo  
Manual de instrucciones

**VEVOR**<sup>®</sup>  
TOUGH TOOLS, HALF PRICE

BANCO DE TRABAJO

ET-24-18 / ETG-24-24 / ET-30-30

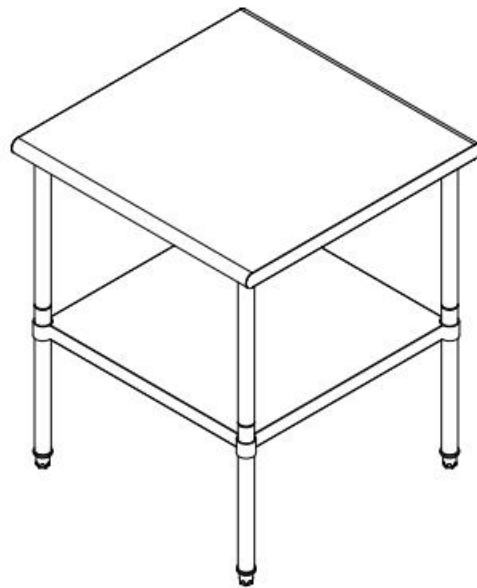

### NEED HELP? CONTACT US!

Have product questions? Need technical support?  
Please feel free to contact us:

 [CustomerService@vevor.com](mailto:CustomerService@vevor.com)









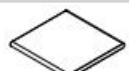

This is the original instruction, Please read all manual instructions carefully before operating. VEVOR reserves clear interpretation of our user manual. The appearance of the product shall be subject to the product you received. Please forgive us that we won't inform you again if there is any technology or software updates on our product.

01

### Parámetros del producto

Modelo	Espesor	Material	Dimensión (Largo x Ancho x Alto)
ET-24-18	0.8 milímetros	Acero inoxidable 201	609.6 × 457.2 × 914.4 mm (24 × 18 × 36 pulgadas)
ETG-24-24	0.8 milímetros	Acero inoxidable 201	609.6 × 609.6 × 914.4 mm (24 × 24 × 36 pulgadas)
ET-30-30	0.8 milímetros	Acero inoxidable 201	762 × 762 × 914.4 mm (30 × 30 × 36 pulgadas)

### Lista de embalaje

Artículo	Part Name	CANTIDAD	Imagen
1	Panel	1 pieza	
2	Estantes	4 piezas	
3	Upper support tube	4 piezas	
4	Lower support tube	4 piezas	
5	Manguitos de montaje	4 piezas	
6	Supporting feet	4 piezas	
7	M6 flat head bolts	5 piezas	
8	Perno de apriete M8	5 piezas	
9	Base hexagonal	1 pieza	
10	Ruedas universales de 3 pulgadas (2 con frenos) Nota: Solo el modelo ETG-24-24 tiene ruedas	4 piezas	

02

**VEVOR**<sup>®</sup>  
TOUGH TOOLS, HALF PRICE

Certificado de soporte y garantía electrónica <https://www.vevor.com/support>  
Hecho en china

Una vez completada la instalación, ajuste la altura de los cuatro support feet(or casters)to ensure that the four feet of the El banco de trabajo está cerca del suelo y la mesa no se puede mover.

### Precauciones

Precauciones:

Algunos modelos de bancos de trabajo están equipados con ruedas. Reemplazar las ruedas, si no es necesario mover el banco de trabajo. Por favor, pise los frenos de las ruedas para asegurarse de que El banco de trabajo no se mueve al empujarlo.

Cada banco de trabajo tiene un límite de peso máximo, tenga cuidado de no exceder el peso máximo al utilizarlo.

Dirección: Baoshanqu Shuangchenglu 803long 11hao 1602A-1609shi

Llevar a la fuerza

Imported to AUS: SIHAO PTY LTD, 1 ROKEVA STREETEASTWOOD NSW 2122 Australia

Imported to USA: Sanven Technology Ltd., Suite 250, 9166 Anaheim Place, Rancho Cucamonga, CA 91730

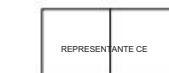

SHUNSHUN GmbH  
Römeracker 9 Z2021, 76351  
Linkenheim-Hochstetten, Alemania



Grupo Pooledas Ltd.  
Unit 5 Albert Edward House,  
Los pabellones de Preston, Reino Unido

HECHO EN CHINA

### Lista de embalaje

Estas son las instrucciones originales, lea todas las instrucciones del manual. carefully before operating. VEVOR reserves clear interpretation of Nuestro manual de usuario.

La apariencia del producto estará sujeta al producto que usted recibió.

Por favor, perdónenos por no informarle nuevamente si hay alguna actualización tecnológica o de software en nuestro producto.

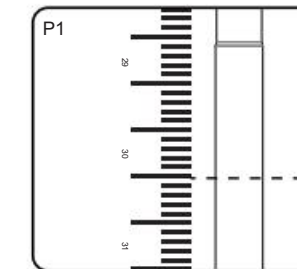

Utilice una regla para medir la altura requerida en el tubo redondo inferior y márquela.

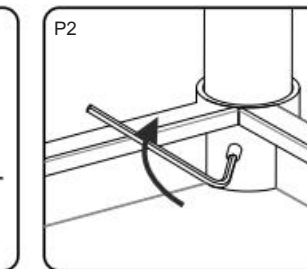

Instale el divisor de acuerdo con las Etiqueta y utilice el perno de ajuste M8 para establecer el torque en 25 N m o más.

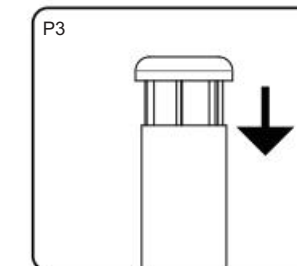

Tome el manguito de montaje y presiónelo en el tubo redondo inferior.

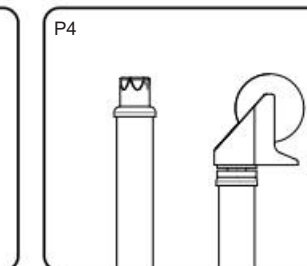

Instalar los pies (o ruedas)  
Nota: Solo el modelo ETG-24-24 tiene ruedas

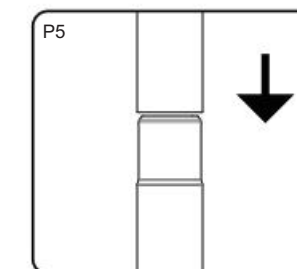

Coloque el producto directamente sobre el floor and put on the up round tube.

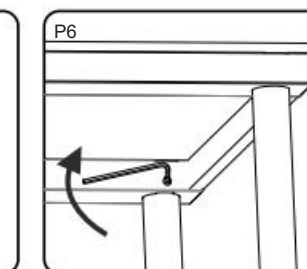

Instale el panel en el orificio y utilice M6 flat head bolts to fix the torque mayor o igual a 25 N m

03