

# **VEVOR<sup>®</sup>**

## **TOUGH TOOLS, HALF PRICE**

Technical Support and E-Warranty Certificate [www.vevor.com/support](http://www.vevor.com/support)

### **Baseball and Softball Batting Cage Net and Frame**

**MODEL: YC-DJL-33×12×10ft**

We continue to be committed to provide you tools with competitive price.

"Save Half", "Half Price" or any other similar expressions used by us only represents an estimate of savings you might benefit from buying certain tools with us compared to the major top brands and does not necessarily mean to cover all categories of tools offered by us. You are kindly reminded to verify carefully when you are placing an order with us if you are actually saving half in comparison with the top major brands.

**VEVOR**<sup>®</sup>  
TOUGH TOOLS, HALF PRICE

**Baseball and Softball  
Batting Cage Net and Frame**

**MODEL: YC-DJL-33×12×10ft**



**NEED HELP? CONTACT US!**

Have product questions? Need technical support? Please feel free to contact us:

**Technical Support and E-Warranty Certificate**  
**[www.vevor.com/support](http://www.vevor.com/support)**

This is the original instruction, please read all manual instructions carefully before operating. VEVOR reserves a clear interpretation of our user manual. The appearance of the product shall be subject to the product you received. Please forgive us that we won't inform you again if there are any technology or software updates on our product.



Warning-To reduce the risk of injury, user must read instructions manual carefully.

## SAFETY WARNINGS AND PRECAUTIONS

Thank you for using this product. In order to make sure that you can operate the machine correctly, read this instruction carefully before operation and keep it properly for future reference. Please be sure to read the precautions and safety rules in this page to ensure your safe use. This manual will outline safety warnings and precautions, operating, maintenance and cleaning. The warnings and instructions reviewed in this manual cannot cover all possible conditions and situations that may occur. Caution and common sense are not built into this product, since we believe that the uses will comply with these codes.

**Please read ALL the instructions before using your machine.**

1. Assemble needs to follow these instructions. Incorrect assembly can be a hazard.
2. Do not assemble when tired or when under the influence of alcohol, drugs or medication.
3. Weight and elastic and other product properties are only applicable to correctly and completely assembled products.
4. Keep the assembly area clean and well-lit.
5. Keep bystanders out of the area during assembly.
6. This is a sports training equipment, not a toy, it needs to be used under the guidance of a coach. Do not allow children and pets to play alone or approach this item. Can't Climb Products.
7. Use as intended only. Do not sit or stand on the product.
8. Inspect before every use. Do not use it if parts are loose or damaged.
9. People or objects hanging on the product will cause the product to fall.
10. Pay attention to pedestrians and vehicles when using.
11. Do not apply this unit to any other purposes than the indicated usage.
12. Baseball and Softball Batting Cage Net and Frame cannot place items to avoid damage.

13. Do not use it for commercial purposes.
14. Do not clean it with any abrasive material.
15. Never leave it unattended while in use.
16. Pet urine and feces can damage the product, please keep away.
17. Do not place the product on or near hot air, electric burners or heaters. Fireworks, cigarettes, flares, and other items can ignite the product. Please stay away from them.
18. The product should be placed on a flat surface. And it should be installed in an open and safe place, avoiding places near windows, roads, railways, rivers, etc.
19. Sports equipment (soccer boots, football gloves, etc.) should be worn during use. Do not place it in a damp environment.

**⚠ WARNING:**

- 20. Ground nails must be used to fix the product on the ground (to ensure the reliability of the ground itself) to prevent it from falling.**
- 21. This appliance is not intended for use by young or infirm persons unless supervised by a responsible person to ensure that they can use the appliance safely. Young children should be supervised to ensure that they do not play with the product. Pets should stay away from the product. Do not use outdoors in rainy and cloudy days, avoid lightning strikes and falls. People or pets hanging on the product will cause injury or death.**

## TECHNICAL SPECIFICATIONS

Model	Number of arches	Arch material	Glass fiber rod diameter
YC-DJL-33×12×10ft	4	Fibre glass pole	∅ 11mm

## ASSEMBLY STEPS

1. Please dispose of all plastic bags carefully and keep them away from children and pet.
2. Check all components provided according to the list in this manual. Make sure you have all of the parts listed.

3. Although paying particular attention when manufacturing this product, you must be careful during the assembly process to avoid being scratched by sharp edges.







4. Wear protective gloves, during assembly and using.

5. The product should be placed on a flat surface.

6. The product requires two people to assemble.

7. The product requires the use of a hammer (Hammer need to be purchased by oneself).

**Attention: Ground nails must be used to fix the product on the ground (to ensure the reliability of the ground itself) to prevent it from falling.**

Parts No.	Picture	Qty	Parts No.	Picture	Qty
①		8 PCS	⑤		12 PCS
②		4*10 PCS	⑥		8 PCS
③		1 PCS	⑦		1PCS
④		12 PCS			

**Note: the quantity of parts shown in the manual is the actual usage and the unused parts are spare parts. Please pay attention to the number label on the surface of the packaging.**

## Drawing And Installation INSTRUCTIONS

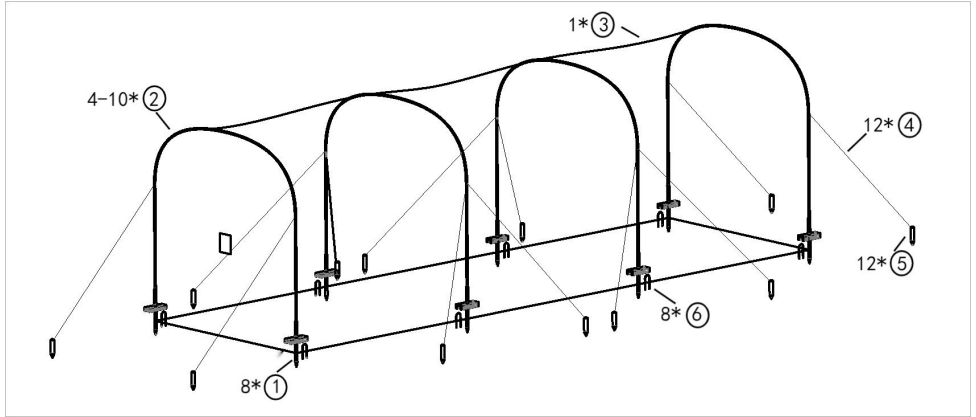

## CLEANING AND STORAGE

1. Wipe with a soft, dry cloth. Never use an abrasive cleanser or harsh pad. Do not clean with water or other liquids. Be sure to keep the product dry
2. Children are **not allowed** to wipe the product to avoid tipping and falling injuries.
3. After the product is disassembled, please put the parts and accessories together.

**Imported to AUS:** SIHAO PTY LTD, 1 ROKEVA STREET EASTWOOD NSW 2122 Australia

**Imported to USA:** Sanven Technology Ltd., Suite 250, 9166 Anaheim Place, Rancho Cucamonga, CA 91730

**Made In China**

**VEVOR<sup>®</sup>**

**TOUGH TOOLS, HALF PRICE**

**Technical Support and E-Warranty Certificate**

**[www.vevor.com/support](http://www.vevor.com/support)**