

VEVOR[®]

TOUGH TOOLS, HALF PRICE

Technical Support and E-Warranty Certificate www.vevor.com/support

GRIDWALLS USER MANUAL

MODEL:YD0024

We continue to be committed to provide you tools with competitive price.

"Save Half", "Half Price" or any other similar expressions used by us only represents an estimate of savings you might benefit from buying certain tools with us compared to the major top brands and does not necessarily mean to cover all categories of tools offered by us. You are kindly reminded to verify carefully when you are placing an order with us if you are actually saving half in comparison with the top major brands.

VEVOR®

TOUGH TOOLS, HALF PRICE

GRIDWALLS

MODEL:YD0024

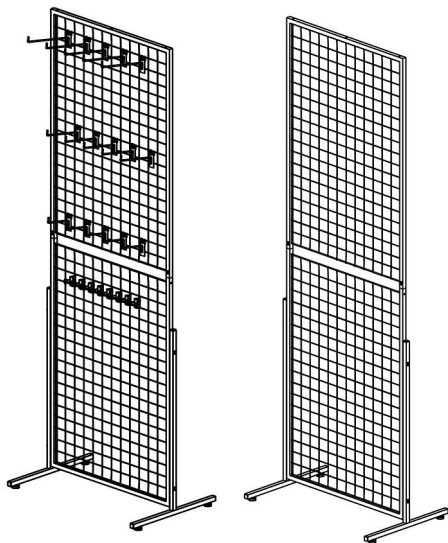

NEED HELP? CONTACT US!

Have product questions? Need technical support? Please feel free to contact us: **Technical Support and E-Warranty Certificate**
www.vevor.com/support

This is the original instruction, please read all manual instructions carefully before operating. VEVOR reserves a clear interpretation of our user manual. The appearance of the product shall be subject to the product you received. Please forgive us that we won't inform you again if there are any technology or software updates on our product.

SAFETY INSTRUCTIONS

WARNING:

Read this material before using this product. Failure to do so can result in serious injury.

Assembly precautions

1. Assemble only according to these instructions. Improper assembly can create hazards.
2. Wear ANSI-approved safety goggles and heavy-duty work gloves during assembly.
3. Keep the assembly area clean and well-lit.
4. Keep bystanders out of the area during assembly.
5. Do not assemble when tired or when under the influence of alcohol, drugs or medication.
6. The product capabilities apply to properly and completely assembled products only.
7. Assemble on a flat, level, hard and smooth surface capable of safely supporting the Gridwalls.
8. For additional information regarding the parts listed in the following pages, please refer to the Assembly Diagram of this manual. Unwrap and separate all parts in a clean work area.

Use precautions

1. DO NOT SIT OR STAND ON THIS ITEM.
2. This product is not a toy. Do not allow children to play with or near this item.
3. Do not exceed weight capacities.
4. Use only on a flat, level, hard and smooth surface capable of safely supporting a fully loaded Gridwalls.
5. Use as intended only.
6. Inspect before every use; do not use if parts are loose or damaged.

SAVE THIS MANUAL

PARTS LIST

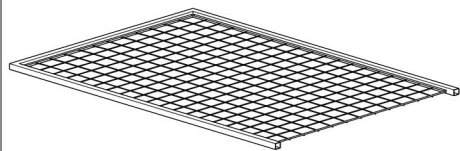

1.Top Mesh x2

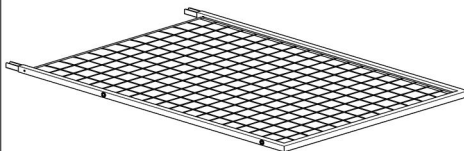

2.Bottom Mesh x2

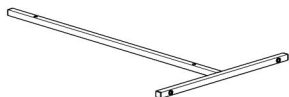

3.Foot Frame x4

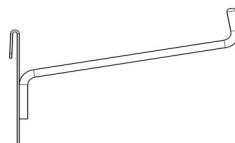

4.Pot Hook_Small x5

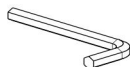

5.Spanner x1

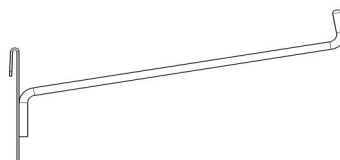

6.Pot Hook_Middle x5

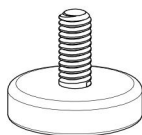

7.LevelingFoot x8

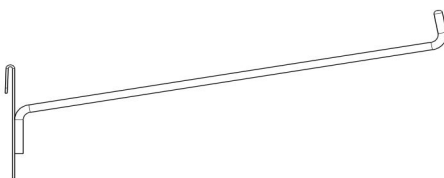

8.Pot Hook_Large x5



9.Screw_A x4

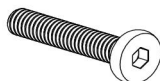

10.Screw_B x8



11.Clip x8

ASSEMBLY STEP

step 1

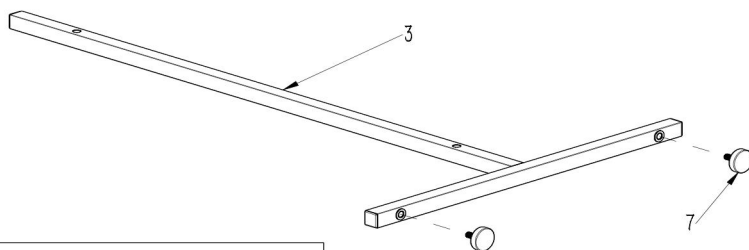

Component 1

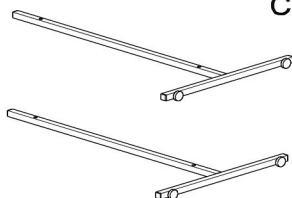

7



X4

step 2

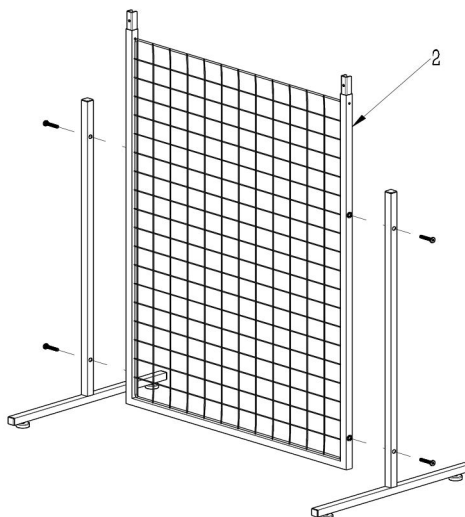

Component 2

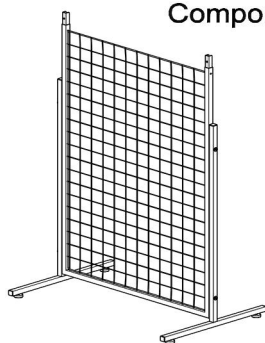

10



X4

step 3

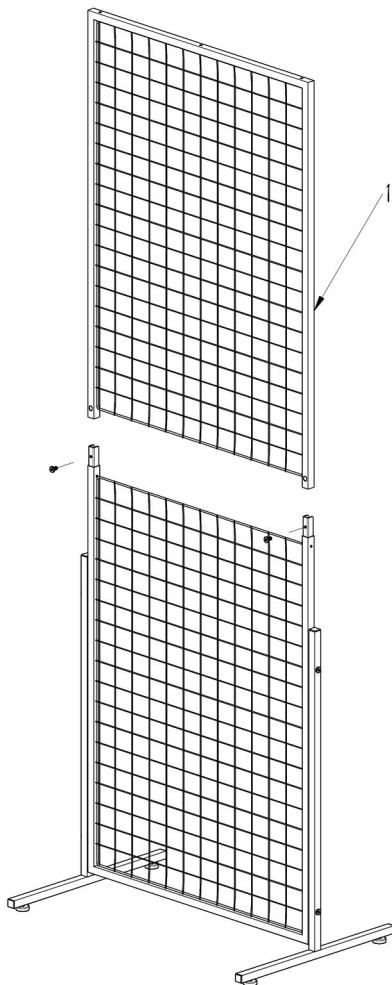

Component 3

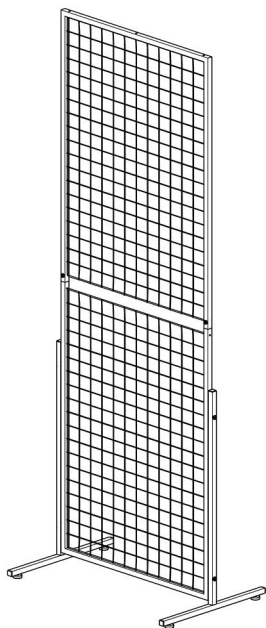

9



X2

step 4

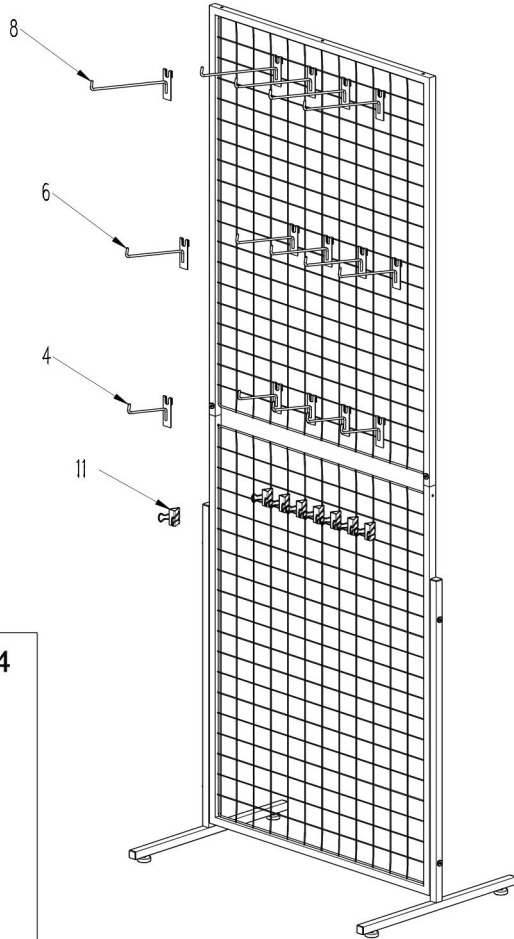

Component 4

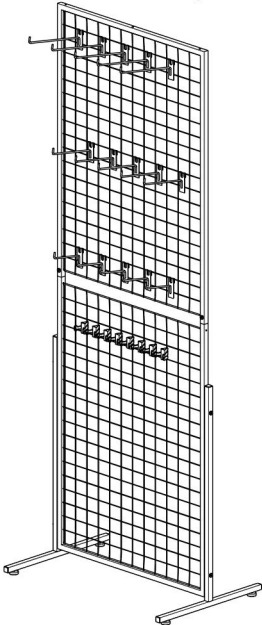

COMPLETION

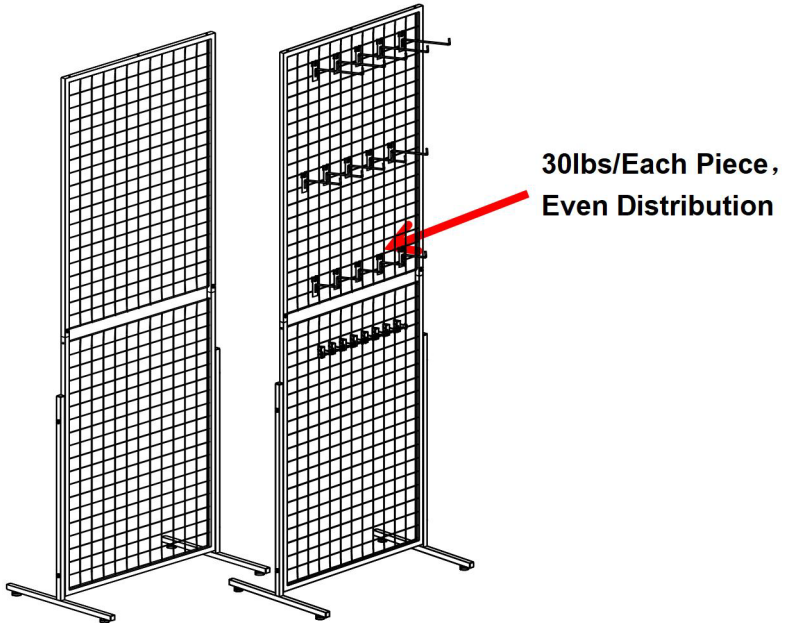

PRODUCT PARAMETER

Model	YD0024
Loading Weight	30 lbs per piece
Product Size	1716*617*404 mm /piece

Manufacturer: Shanghaimuxinmuyeyouxiangongsi

**Address: Shuangchenglu 803nong11hao1602A-1609shi,
baoshanqu, shanghai 200000 CN.**

**Imported to AUS: SIHAO PTY LTD. 1 ROKEVA STREETEAST-
WOOD NSW 2122 Australia**

**Imported to USA: Sanven Technology Ltd. Suite 250, 9166 Ana-
heim Place, Rancho Cucamonga, CA 91730**



**E-CrossStu GmbH
Mainzer Landstr.69, 60329 Frankfurt am Main.**



**YH CONSULTING LIMITED.
C/O YH Consulting Limited Office 147, Centurion House,
London Road, Staines-upon-Thames, Surrey, TW18 4AX**

VEVOR[®]

TOUGH TOOLS, HALF PRICE

Technical Support and E-Warranty Certificate

www.vevor.com/support

VEVOR®

TOUGH & MCO, HALF PRICE

Assistance technique et certificat de garantie électronique www.vevor.com/support

PAROIS GRILLEES

MANUEL D'UTILISATION

MODÈLE : YD0024

Nous continuons à nous engager à vous fournir des outils à des prix compétitifs.

« Économisez la moitié », « Moitié prix » ou toute autre expression similaire utilisée par nous ne représente qu'une estimation des économies que vous pourriez réaliser en achetant certains outils chez nous par rapport aux grandes marques et ne signifie pas nécessairement couvrir toutes les catégories d'outils que nous proposons.

Nous vous rappelons de bien vouloir vérifier soigneusement lorsque vous passez une commande chez nous si vous économisez réellement la moitié par rapport aux grandes marques.

VEVOR[®]

TOUG H À MCO, H ALF P RIZ

PAROIS GRILLEES

MODÈLE : YD0024

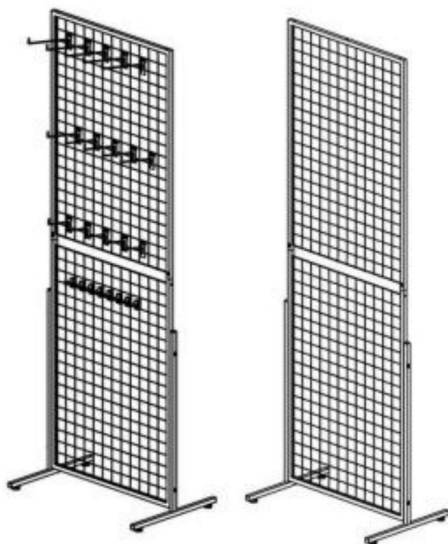

BESOIN D'AIDE? CONTACTEZ-NOUS!

Vous avez des questions sur nos produits ? Vous avez besoin d'assistance technique ?

N'hésitez pas à nous contacter : Assistance technique et certificat de garantie
électronique www.vevor.com/support

Il s'agit de la notice d'utilisation d'origine. Veuillez lire attentivement toutes les instructions du manuel avant de l'utiliser. VEVOR se réserve le droit d'interpréter clairement notre manuel d'utilisation. L'apparence du produit dépend du produit que vous avez reçu. Veuillez nous excuser, nous ne vous informerons plus en cas de mise à jour technologique ou logicielle de notre produit.

CONSIGNES DE SÉCURITÉ

AVERTISSEMENT :

Lisez attentivement ce document avant d'utiliser ce produit. Le non-respect de cette consigne peut entraîner des blessures graves.

Précautions d'assemblage 1.

Assemblez uniquement selon ces instructions. Un assemblage incorrect peut
créer des dangers.

2. Portez des lunettes de sécurité homologuées ANSI et des gants de travail robustes pendant le montage.
3. Gardez la zone de montage propre et bien éclairée.
4. Gardez les spectateurs hors de la zone pendant le montage.
5. Ne montez pas lorsque vous êtes fatigué ou sous l'influence de l'alcool, de drogues ou de médicaments.
6. Les capacités du produit s'appliquent aux produits correctement et complètement assemblés.
produits uniquement.
7. Assemblez sur une surface plane, de niveau, dure et lisse capable de supporter en toute sécurité
soutenir les Gridwalls.
8. Pour plus d'informations sur les pièces répertoriées ci-dessous
pages, veuillez vous référer au schéma d'assemblage de ce manuel. Déballez et séparez toutes les
pièces dans un espace de travail propre.











Précautions d'utilisation 1.

NE PAS S'ASSEOIR OU SE TENIR DEBOUT SUR CET ARTICLE.

2. Ce produit n'est pas un jouet. Ne laissez pas les enfants jouer avec ou à proximité de ce produit.
article.
3. Ne pas dépasser les capacités de poids.
4. Utiliser uniquement sur une surface plane, nivelée, dure et lisse capable de supporter en toute sécurité
prenant en charge un Gridwalls entièrement chargé.
5. Utiliser uniquement comme prévu.
6. Inspectez avant chaque utilisation ; ne pas utiliser si des pièces sont desserrées ou endommagées.

CONSERVER CE MANUEL

LISTE DES PIÈCES

 <p>Maillage ITop x2</p>	 <p>2.Maillage inférieur x2</p>	
 <p>3. Cadre de pied x4</p>	 <p>4. Crochet pour pot_Petit x5</p>	
 <p>5.Spanner x1</p>	 <p>6. Crochet de pot_milieu x5</p>	
 <p>7. Pied de nivellement x8</p>	 <p>8.Pot Hook_Large x5</p>	
 <p>9. Vis_A x4</p>	 <p>10.Vis_B x8</p>	 <p>11.Clip x8</p>

ÉTAPE D'ASSEMBLAGE

step 1

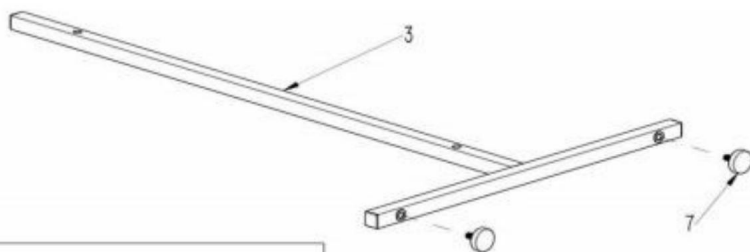

Component 1

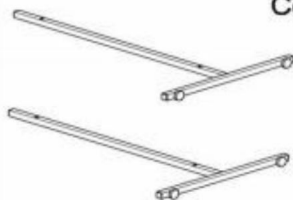

7



X4

étape 2

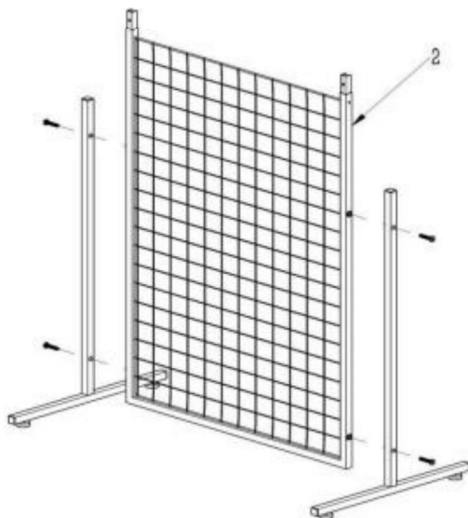

Component 2



10



X4

step 3

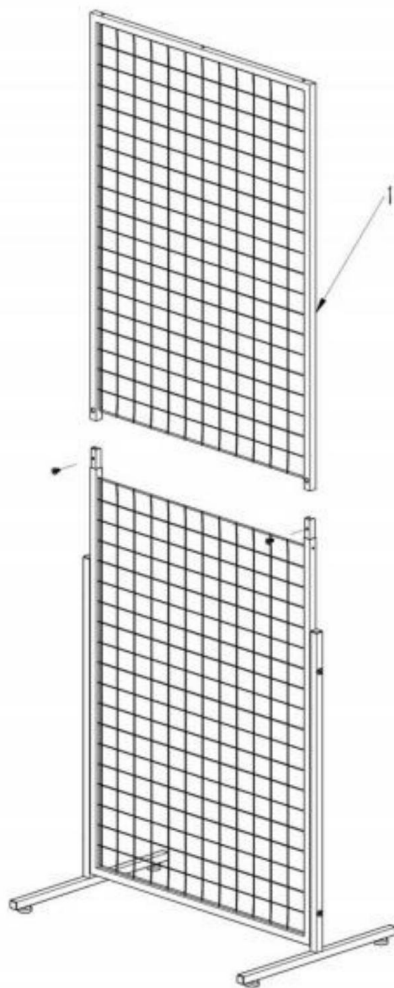

Component 3

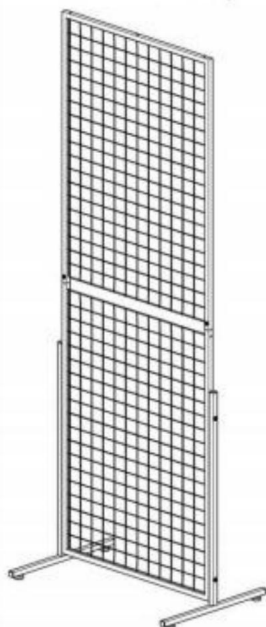

9



X2

step 4

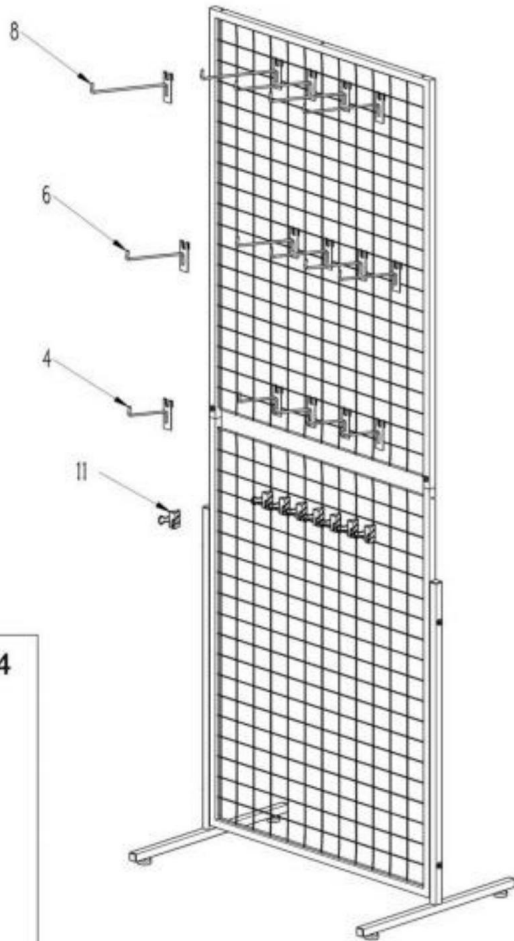

Component 4

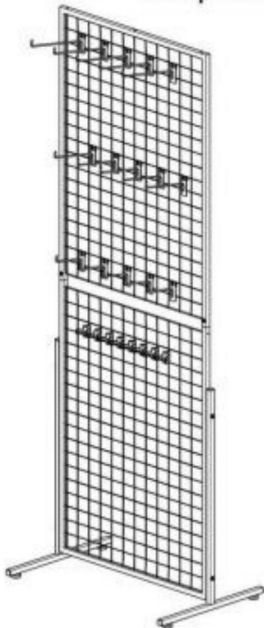

ACHÈVEMENT



PARAMÈTRE DU PRODUIT

Modèle	YD0024
Poids de chargement	30 livres par pièce
Taille du produit	1716*617*404 mm/pièce

Fabricant : Shanghaimuxinmuyeyouxiangongsi

Adresse : Shuangchenglu 803nong11 hao1602A-1609shi,

Baoshanqu, Shanghai 200000 CN.

Importé en Australie : SIHAO PTY LTD. 1 ROKEVA STREETEAST-WOOD NSW2122
Australie

Importé aux États-Unis : San Ven Technology Ltd. Suite 250, 9166 Anaheim Place,
Rancho Cucamonga, CA91730

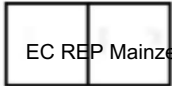

E-CrossStu GmbH

EC REP Mainzer Landstr.69, 60329 Francfort-sur-le-Main.



YH CONSULTING LIMITÉE.

C/O YH Consulting Limited Bureau 147, Centurion House,
Route de Londres, Staines-upon-Thames, Surrey, TW18 4AX

VEVOR[®]

OUTILS ROBUSTES, MOITIÉ PRIX

Assistance technique et certificat de garantie
électronique www.vevor.com/support

V UND V DER R[®]

TOUGH ZUOLS, HALF PREIS

Technischer Support und E-Garantie-Zertifikat www.vevor.com/support

GITTERWÄNDE

BENUTZERHANDBUCH

MODELL:YD0024

Wir sind weiterhin bestrebt, Ihnen Werkzeuge zu wettbewerbsfähigen Preisen anzubieten.

„Sparen Sie die Hälfte“, „Halber Preis“ oder andere ähnliche Ausdrücke, die wir verwenden, stellen lediglich eine Schätzung der Ersparnis dar, die Sie beim Kauf bestimmter Werkzeuge bei uns im Vergleich zu den großen Topmarken erzielen können, und müssen nicht unbedingt alle von uns angebotenen Werkzeugkategorien abdecken. Wir möchten Sie freundlich daran erinnern, bei Ihrer Bestellung bei uns sorgfältig zu prüfen, ob Sie im Vergleich zu den großen Topmarken tatsächlich die Hälfte sparen.

V UND V DER R[®]

GITTERWÄNDE

TOUGH ZUOLS, HALF PREIS

MODELL: YD0024

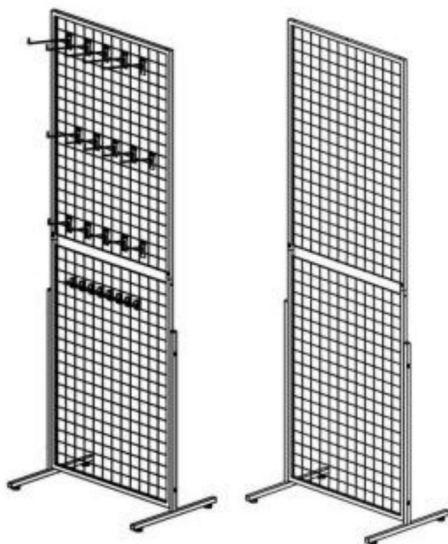

Brauchen Sie Hilfe? Kontaktieren Sie uns!

Haben Sie Fragen zum Produkt? Benötigen Sie technischen Support? Bitte kontaktieren Sie uns: Technischer Support und E-Garantie-Zertifikat www.vevor.com/support

Dies ist die Originalanleitung. Bitte lesen Sie alle Anweisungen sorgfältig durch, bevor Sie das Gerät in Betrieb nehmen. VEVOR behält sich eine klare Auslegung unserer Bedienungsanleitung vor. Das Erscheinungsbild des Produkts richtet sich nach dem Produkt, das Sie erhalten haben. Bitte verzeihen Sie uns, dass wir Sie nicht erneut informieren, wenn es Technologie- oder Software-Updates für unser Produkt gibt.

SICHERHEITSHINWEISE

ACHTUNG:

Lesen Sie diese Informationen, bevor Sie das Produkt verwenden. Andernfalls kann es zu schweren Verletzungen kommen.

Vorsichtsmaßnahmen bei der











- Montage** 1. Die Montage muss gemäß dieser Anleitung erfolgen. Eine unsachgemäße Montage kann Gefahren schaffen.
2. Tragen Sie ANSI-zugelassene Schutzbrillen und strapazierfähige Arbeitshandschuhe bei der Montage.
3. Halten Sie den Versammlungsbereich sauber und gut beleuchtet.
4. Halten Sie während der Montage unbeteiligte Zuschauer vom Bereich fern.
5. Nicht montieren, wenn Sie müde sind oder unter dem Einfluss von Alkohol, Drogen oder Medikamenten stehen.
6. Die Produkteigenschaften gelten für ordnungsgemäß und vollständig montierte Nur Produkte.
7. Auf einer flachen, ebenen, harten und glatten Oberfläche montieren, die sicher Unterstützung der Gridwalls.
8. Weitere Informationen zu den im Folgenden aufgeführten Teilen finden Sie Seiten finden Sie im Montagediagramm dieses Handbuchs. Packen Sie alle Teile in einem sauberen Arbeitsbereich aus und trennen Sie sie.

Vorsichtsmaßnahmen

- treffen** 1. NICHT AUF DIESEM GEGENSTAND SITZEN ODER STEHEN.
2. Dieses Produkt ist kein Spielzeug. Erlauben Sie Kindern nicht, mit oder in der Nähe dieses Artikel.
3. Überschreiten Sie nicht die zulässige Gewichtsgrenze.
4. Nur auf einer flachen, ebenen, harten und glatten Oberfläche verwenden, die sicher unterstützt vollständig geladene Gridwalls.
5. Nur bestimmungsgemäß verwenden.
6. Vor jedem Gebrauch prüfen; nicht verwenden, wenn Teile lose oder beschädigt sind.

BEWAHREN SIE DIESES HANDBUCH AUF

TEILELISTE

 <p>1.Top Mesh x2</p>	 <p>2.Unteres Netz x2</p>	
 <p>3. Fußrahmen x4</p>	 <p>4.Topfhaken_Klein x5</p>	
 <p>5. Schraubenschlüssel x1</p>	 <p>6.Topfhaken_Mitte x5</p>	
 <p>7.Nivellierfuß x8</p>	 <p>8.Pot Hook_Large x5</p>	
 <p>9.Schraube_A x4</p>	 <p>10.Schraube_B x8</p>	 <p>11.Clip x8</p>

MONTAGESTRITT

step 1

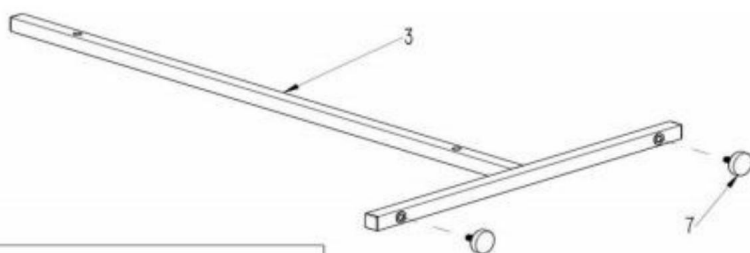

Component 1



7



X4

Schritt 2

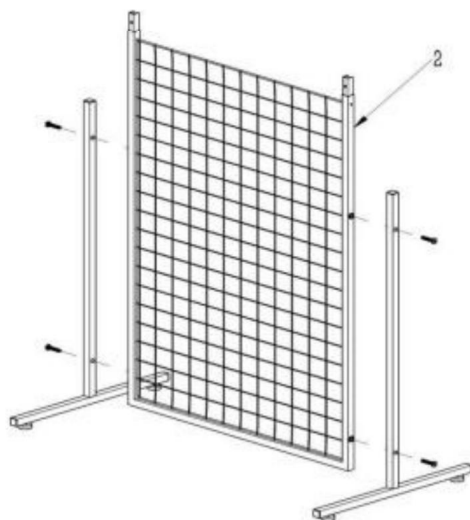

Component 2



10



X4

step 3

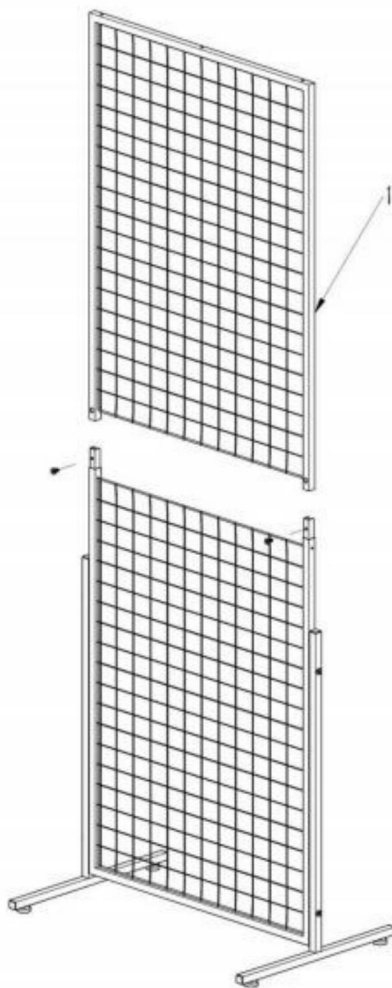

Component 3

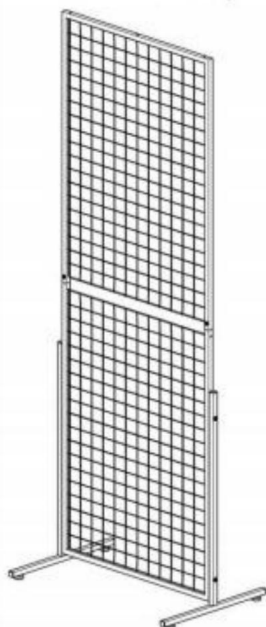

9



X2

step 4

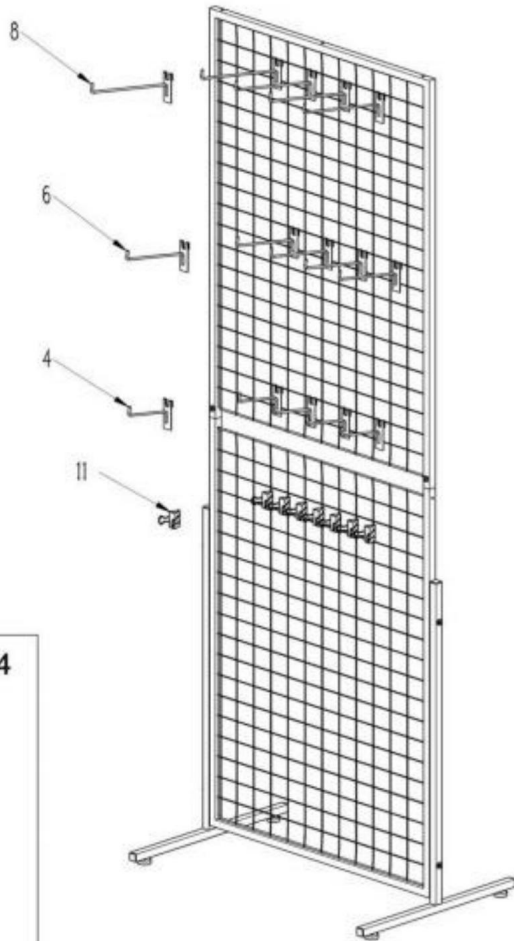

Component 4

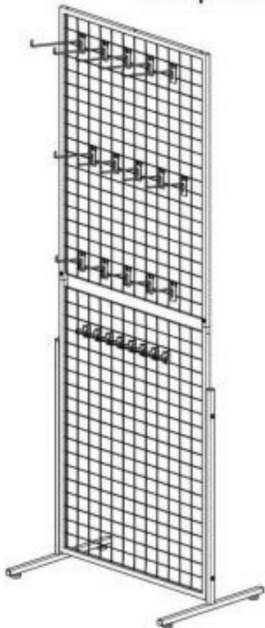

FERTIGSTELLUNG



PRODUKTPARAMETER

Modell	YD0024
Ladegewicht	30 Pfund pro Stück
Produktgröße	1716*617*404 mm /Stück

Hersteller: Shanghaimuxinmuyeyouxiangongsi

Adresse: Shuangchenglu 803nong11 hao1602A-1609shi,
Baoshanqu, Shanghai 200000 CN.

Nach AUS importiert: SIHAO PTY LTD. 1 ROKEVA STREETEAST-WOOD NSW2122
Australien

Importiert in die USA: San ven Technology Ltd. Suite 250, 9166 Ana-heim Place,
Rancho Cucamonga, CA91730

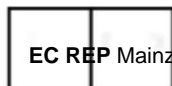

E-CrossStu GmbH
Mainzer Landstr.69, 60329 Frankfurt am Main.



YH CONSULTING LIMITED.
C/O YH Consulting Limited Office 147, Centurion House,
London Road, Staines-upon-Thames, Surrey, TW18 4AX

VEVOR[®]

ROBUSTE WERKZEUGE ZUM HALBEN PREIS

Technischer Support und E-Garantie-Zertifikat

www.vevor.com/support

VEVILR®

TOCCARE HA OLS, HALF PRISO

Supporto tecnico e certificato di garanzia elettronica www.vevor.com/support

GRIGLIATI MANUALE D'USO

MODELLO:YD0024

Continuiamo a impegnarci per fornirvi strumenti a prezzi competitivi.

"Risparmia la metà", "Metà prezzo" o qualsiasi altra espressione simile da noi utilizzata rappresenta solo una stima del risparmio che potresti ottenere acquistando determinati utensili con noi rispetto ai principali marchi principali e non significa necessariamente coprire tutte le categorie di utensili da noi offerti. Ti ricordiamo gentilmente di verificare attentamente quando effettui un ordine con noi se stai effettivamente risparmiando la metà rispetto ai principali marchi principali.

VEVILR[®]

TOCCAREH A OLS, H ALF P RISO

GRIGLIATI

MODELLO:YD0024

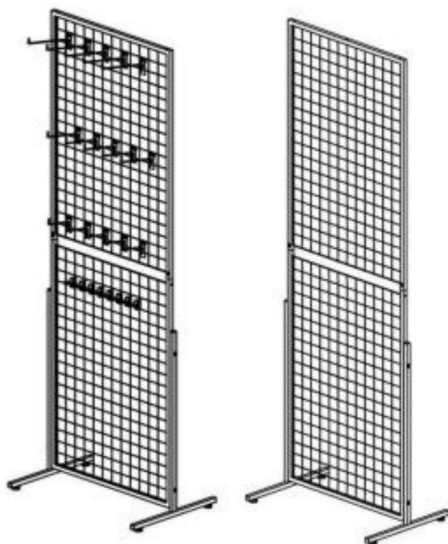

HAI BISOGNO DI AIUTO? CONTATTACI!

Hai domande sul prodotto? Hai bisogno di supporto tecnico? Non esitare a contattarci: Supporto tecnico e certificato di garanzia elettronica www.vevor.com/support

Questa è l'istruzione originale, si prega di leggere attentamente tutte le istruzioni del manuale prima di utilizzare. VEVOR si riserva una chiara interpretazione del nostro manuale utente. L'aspetto del prodotto sarà soggetto al prodotto ricevuto. Vi preghiamo di perdonarci se non vi informeremo di nuovo se ci sono aggiornamenti tecnologici o software sul nostro prodotto.

ISTRUZIONI DI SICUREZZA

ATTENZIONE:

leggere questo materiale prima di utilizzare questo prodotto. La mancata osservanza di questa precauzione può causare gravi lesioni.

Precauzioni di montaggio 1.

Montare solo secondo queste istruzioni. Un montaggio non corretto può creare pericoli.

2. Indossare occhiali di sicurezza approvati ANSI e guanti da lavoro resistenti durante l'assemblaggio.
3. Mantenere l'area di assemblaggio pulita e ben illuminata.
4. Tenere gli astanti fuori dall'area durante l'assemblea.
5. Non riunirsi quando si è stanchi o sotto l'effetto di alcol, droghe o farmaci.
6. Le capacità del prodotto si applicano a prodotti correttamente e completamente assemblati solo prodotti.
7. Montare su una superficie piana, livellata, dura e liscia in grado di sostenere in modo sicuro a supporto dei Gridwall.
8. Per ulteriori informazioni sulle parti elencate di seguito pagine, fare riferimento allo schema di montaggio di questo manuale. Disimballare e separare tutte le parti in un'area di lavoro pulita.











Usare precauzioni 1.

NON SEDERSI O STARE IN PIEDI SU QUESTO ARTICOLO.

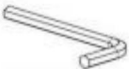
2. Questo prodotto non è un giocattolo. Non permettere ai bambini di giocare con o vicino a questo articolo.
3. Non superare la capacità di peso.
4. Utilizzare solo su una superficie piana, livellata, dura e liscia in grado di resistere in modo sicuro supportando Gridwall completamente carichi.
5. Utilizzare solo come previsto.
6. Ispezionare prima di ogni utilizzo; non utilizzare se alcune parti sono allentate o danneggiate.

SALVA QUESTO MANUALE

ELENCO DELLE PARTI

 <p>Maglia ITop x2</p>	 <p>2. Maglia inferiore x2</p>	
 <p>3. Telaio del piede x4</p>	 <p>4. Gancio per pentola_Piccolo x5</p>	
 <p>5. Chiave x1</p>	 <p>6. Gancio per pentola_Medio x5</p>	
 <p>7. Piedino livellante x8</p>	 <p>8. Pot Hook_Large x5</p>	
 <p>9. Vite_A x4</p>	 <p>10. Vite_B x8</p>	 <p>11. Clip x8</p>

FASE DI MONTAGGIO

step 1

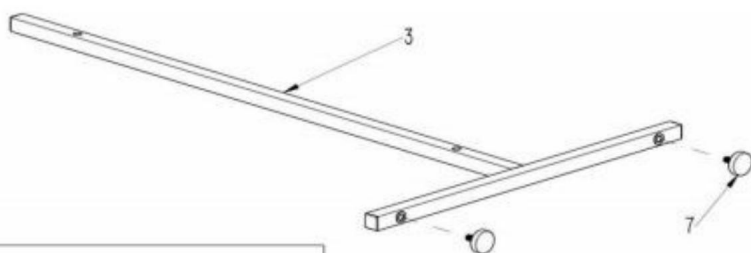

Component 1



7



X4

passo 2

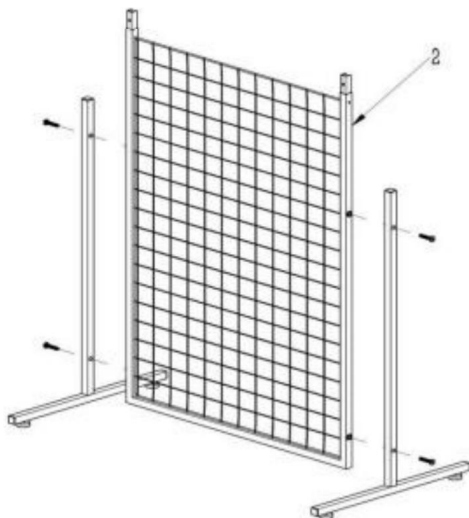

Component 2



10



X4

step 3

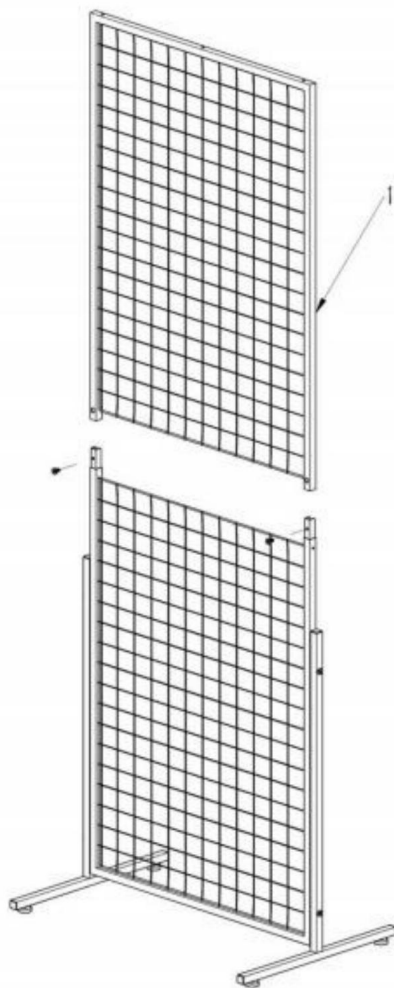

Component 3

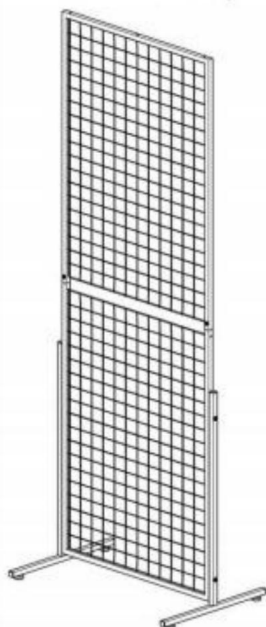

9



X2

step 4

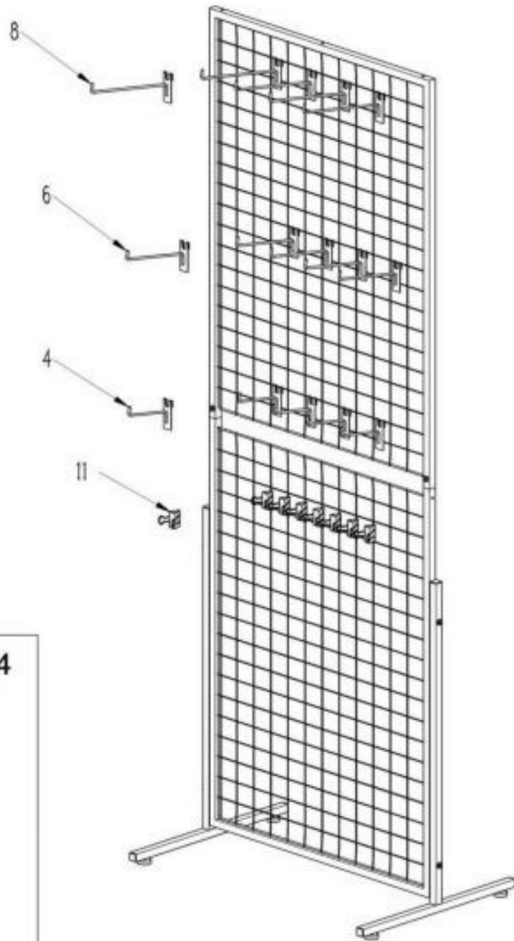

Component 4

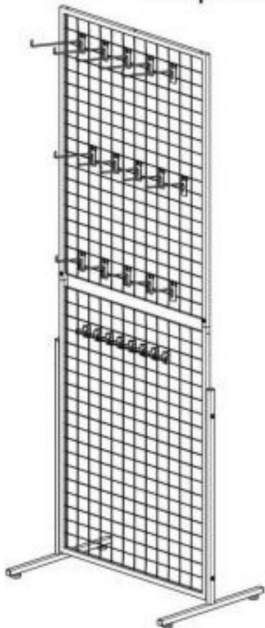

COMPLETAMENTO



PARAMETRO PRODOTTO

Modello	YD0024
Peso di carico	30 libbre per pezzo
Dimensioni del prodotto	1716*617*404 mm /pezzo

Produttore: Shanghai muxinmuyeyouxiangongsi

Indirizzo: Shuangchenglu 803nong11 hao1602A-1609shi,
baoshanqu, shanghai 200000 CN.

Importato in AUS: SIHAO PTY LTD. 1 ROKEVA STREETEAST-WOOD NSW2122
Australia

Importato negli USA: San ven Technology Ltd. Suite 250, 9166 Ana-heim Place, Rancho
Cucamonga, CA91730

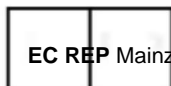

E-CrossStu GmbH
Mainzer Landstr.69, 60329 Francoforte sul Meno.



CONSULENZA YH LIMITATA.
C/O YH Consulting Limited Ufficio 147, Centurion House,
Via Roma, 101, 00186 Roma, Italia

VEVORE[®]

UTENSILI RESISTENTI, A METÀ PREZZO

Supporto tecnico e certificato di garanzia
elettronica www.vevor.com/support

V Y V ELR[®]

TOGOH A OLS, HALF P ARROZ

Soporte técnico y certificado de garantía electrónica www.vevor.com/support

MUROS DE REJILLA

MANUAL DEL USUARIO

MODELO: YD0024

Seguimos comprometidos a brindarle herramientas a precios competitivos.

"Ahorre la mitad", "mitad de precio" o cualquier otra expresión similar que utilicemos solo representa una estimación del ahorro que podría obtener al comprar ciertas herramientas con nosotros en comparación con las principales marcas y no necesariamente significa que cubra todas las categorías de herramientas que ofrecemos. Le recordamos que, al realizar un pedido con nosotros, verifique cuidadosamente si realmente está ahorrando la mitad en comparación con las principales marcas.

VYVELR[®]

TOGO HA OLS, H ALF P ARROZ

MUROS DE REJILLA

MODELO: YD0024

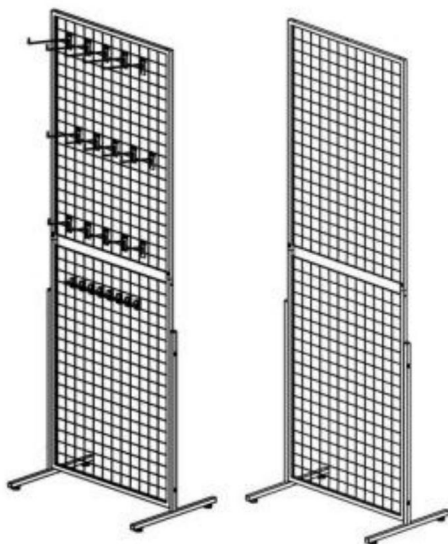

¿NECESITA AYUDA? ¡CONTÁCTENOS!

¿Tiene preguntas sobre el producto? ¿Necesita asistencia técnica? No dude en ponerse en contacto con nosotros: Asistencia técnica y certificado de garantía electrónica www.vevor.com/support

Estas son las instrucciones originales, lea atentamente todas las instrucciones del manual antes de utilizar el producto. VEVOR se reserva una interpretación clara de nuestro manual de usuario. La apariencia del producto estará sujeta al producto que recibió. Perdónenos por no informarle nuevamente si hay actualizaciones de tecnología o software en nuestro producto.

INSTRUCCIONES DE SEGURIDAD

ADVERTENCIA:

Lea este material antes de utilizar este producto. No hacerlo puede provocar lesiones graves.

Precauciones de montaje 1.

Realice el montaje únicamente de acuerdo con estas instrucciones. Un montaje incorrecto puede crear peligros

2. Use gafas de seguridad aprobadas por ANSI y guantes de trabajo resistentes.

Durante el montaje.

3. Mantenga el área de reunión limpia y bien iluminada.

4. Mantenga a los transeúntes fuera del área durante el montaje.

5. No se reúna cuando esté cansado o bajo la influencia del alcohol, drogas o medicamentos.

6. Las capacidades del producto se aplican a productos ensamblados de manera correcta y completa.

Sólo productos.

7. Montar sobre una superficie plana, nivelada, dura y lisa capaz de soportar cargas de forma segura.

apoyando los Gridwalls.

8. Para obtener información adicional sobre las piezas enumeradas a continuación,

páginas, consulte el diagrama de ensamblaje de este manual. Desembale y separe todas las piezas en un área de trabajo limpia.

Precauciones de uso 1.

NO SE SIENTA NI SE PARE SOBRE ESTE ARTÍCULO.

2. Este producto no es un juguete. No permita que los niños jueguen con él o cerca de él.
artículo.

3. No exceda las capacidades de peso.











4. Utilícelo únicamente sobre una superficie plana, nivelada, dura y lisa capaz de soportar cargas de forma segura.
soportando un Gridwalls completamente cargado.

5. Utilícelo únicamente según lo previsto.

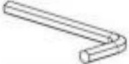
6. Inspeccione antes de cada uso; no utilice si las piezas están sueltas o dañadas.

GUARDE ESTE MANUAL

LISTA DE PIEZAS

 <p>Malla iTop x2</p>	 <p>2. Malla inferior x2</p>	
 <p>3. Marco de pie x4</p>	 <p>4. Gancho para macetas_Pequeño x5</p>	
 <p>5. Llave inglesa x1</p>	 <p>6. Gancho para olla_medio x5</p>	
 <p>7. Pie nivelador x8</p>	 <p>8.Pot Hook_Large x5</p>	
 <p>9.Tornillo A x4</p>	 <p>10.Tornillo_B x8</p>	 <p>11. Clip x8</p>

PASO DE MONTAJE

step 1

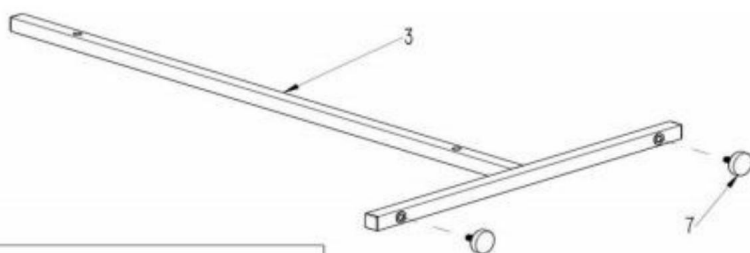

Component 1



7  X4

Paso 2

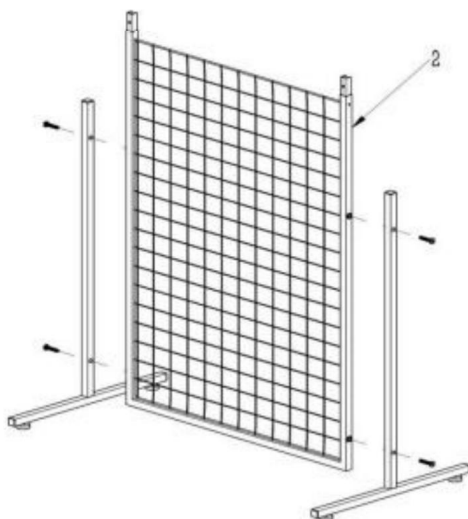

Component 2



10  X4

step 3

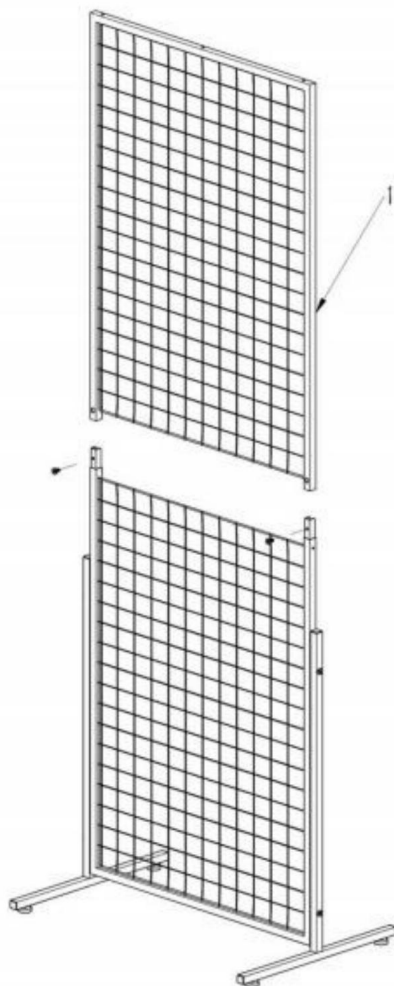

Component 3

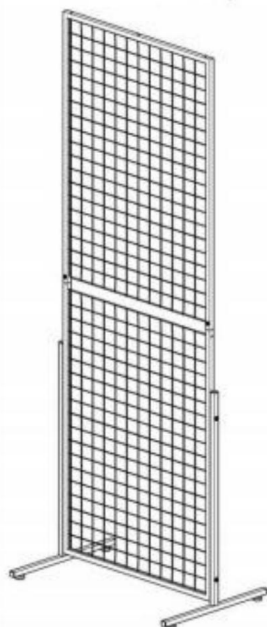

9



X2

step 4

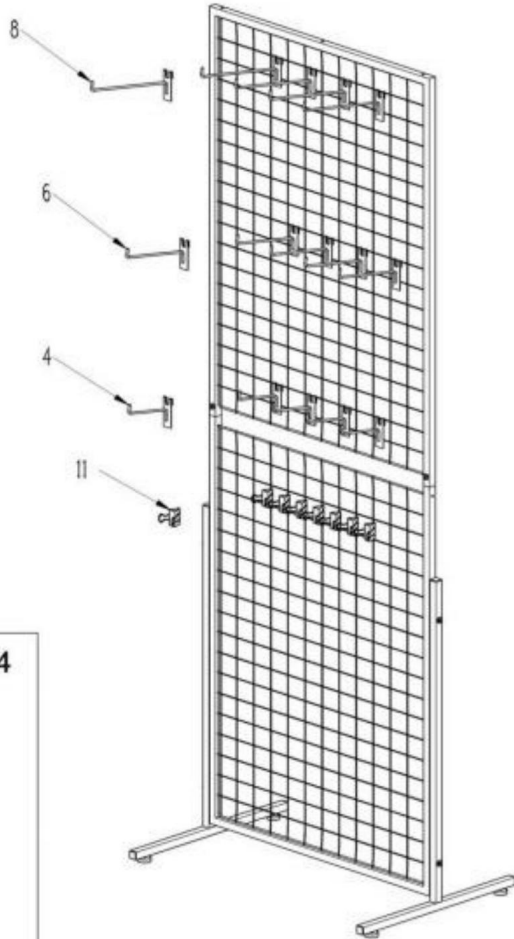

Component 4

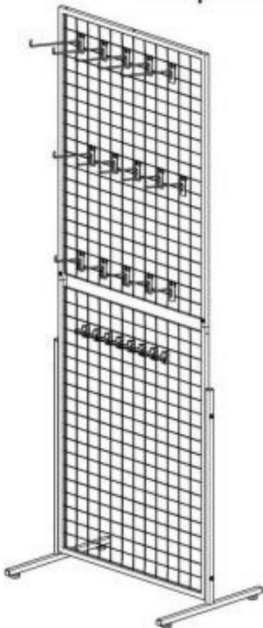

TERMINACIÓN



PARÁMETRO DEL PRODUCTO

Modelo	YD0024
Peso de carga	30 libras por pieza
Tamaño del producto	1716*617*404 mm/pieza

Fabricante: Shanghaimuxinmuyeyouxiangongsi

Dirección: Shuangchenglu 803nong11 hao1602A-1609shi,

Baoshanqu, Shanghái 200000 CN.

Importado a AUS: SIHAO PTY LTD. 1 ROKEVA STREETEAST-WOOD NSW2122
Australia

Importado a EE. UU.: San ven Technology Ltd. Suite 250, 9166 Ana-heim Place, Rancho
Cucamonga, CA 91730

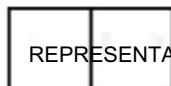

E-CrossStu GmbH

REPRESENTANTE CE Mainzer Landstr.69, 60329 Frankfurt am Main.



YH CONSULTING LIMITADA.

C/O YH Consulting Limited Oficina 147, Centurion House,
Carretera de Londres, Staines-upon-Thames, Surrey, TW18 4AX

VEVOR[®]

HERRAMIENTAS RESISTENTES A MITAD DE PRECIO

Soporte técnico y certificado de garantía
electrónica www.vevor.com/soporte

VEVOR®

TOUGH DUTY, HIGH ALLOY STEEL

Wsparcie techniczne i certyfikat gwarancji elektronicznej www.vevor.com/support

ŚCIANY Z SIATKI

INSTRUKCJA OBSŁUGI

MODEL:YD0024

Nadal staramy się oferować Państwu narzędzia w konkurencyjnych cenach.

„Oszczędź połowę”, „Połowa ceny” lub inne podobne wyrażenia używane przez nas stanowią jedynie szacunkowe oszczędności, jakie możesz uzyskać, kupując u nas określone narzędzia w porównaniu z głównymi markami i niekoniecznie oznaczają one objęcie wszystkich kategorii narzędzi oferowanych przez nas. Upzejmie przypominamy, aby dokładnie sprawdzić, czy składając u nas zamówienie faktycznie oszczędzasz połowę w porównaniu z głównymi markami.

VEVOR[®]

TOUGH HD POLYMER ALF P RYZ

ŚCIANY Z SIATKI

MODEL:YD0024

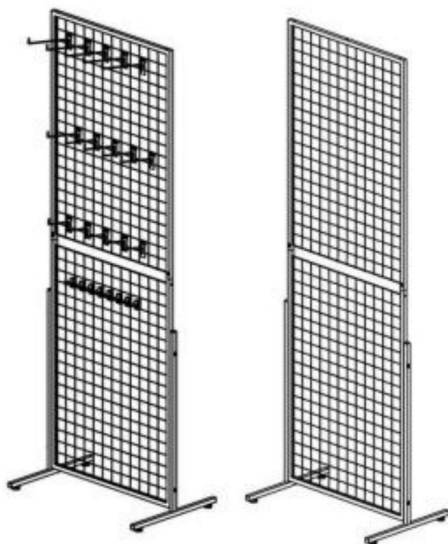

POTRZEBUJESZ POMOCY? SKONTAKTUJ SIĘ Z NAMI!

Masz pytania dotyczące produktu? Potrzebujesz wsparcia technicznego?

Skontaktuj się z nami: Wsparcie techniczne i certyfikat E-Gwarancji www.vevor.com/support

To jest oryginalna instrukcja, przed użyciem należy uważnie przeczytać wszystkie instrukcje. VEVOR zastrzega sobie jasną interpretację naszej instrukcji obsługi. Wygląd produktu będzie zależał od produktu, który otrzymałeś. Prosimy o wybaczenie, że nie poinformujemy Cię ponownie, jeśli w naszym produkcie pojawiają się jakiegokolwiek aktualizacje technologiczne lub oprogramowania.

INSTRUKCJE BEZPIECZEŃSTWA

OSTRZEŻENIE:

Przeczytaj ten materiał przed użyciem tego produktu. Niedopełnienie tego obowiązku może spowodować poważne obrażenia.

Środki ostrożności przy montażu

1. Montaż należy wykonywać wyłącznie zgodnie z niniejszą instrukcją. Nieprawidłowy montaż może stwarzać zagrożenia.
2. Noś okulary ochronne zatwierdzone przez ANSI i wytrzymałe rękawice robocze w trakcie montażu.
3. Utrzymuj miejsce zgromadzenia w czystości i zapewnij dobre oświetlenie.
4. Podczas montażu nie dopuszczaj osób postronnych na teren montażu.
5. Nie przychodź na spotkania, jeśli jesteś zmęczony lub pod wpływem alkoholu, narkotyków lub leków.
6. Możliwości produktu dotyczą prawidłowego i kompletnego montażu tylko produkty.
7. Montaż należy wykonać na płaskiej, równej, twardej i gładkiej powierzchni, która będzie bezpieczna. Wsparcie Gridwalls.
8. Aby uzyskać dodatkowe informacje dotyczące części wymienionych poniżej, strony, zapoznaj się ze schematem montażu w tym podręczniku. Rozpakuj i oddziel wszystkie części w czystym miejscu pracy.











Zachowaj środki

ostrożności 1. NIE SIADAJ ANI NIE STÓJ NA TYM PRZEDMIOCIE.

2. Ten produkt nie jest zabawką. Nie pozwalaj dzieciom bawić się nim ani przebywać w jego pobliżu.
przedmiot.
3. Nie przekraczać dopuszczalnego obciążenia.
4. Używać wyłącznie na płaskiej, równej, twardej i gładkiej powierzchni, która umożliwi bezpieczne użytkowanie.
obsługuje w pełni załadowane Gridwalle.
5. Używać wyłącznie zgodnie z przeznaczeniem.
6. Przed każdym użyciem należy przeprowadzić kontrolę. Nie należy używać produktu, jeśli jakieś części są luźne lub uszkodzone.

ZAPISZ TĘ INSTRUKCJĘ

LISTA CZĘŚCI

 <p>Siatka ITop x2</p>	 <p>2. Siatka dolna x2</p>	
 <p>3. Rama stóp x4</p>	 <p>4.Haczyk na garnki_Mały x5</p>	
 <p>5. Klucz x1</p>	 <p>6. Hak na garnek_Środek x5</p>	
 <p>7. Stopka poziomująca x8</p>	 <p>8.Pot Hook_Large x5</p>	
 <p>9. Śruba_A x4</p>	 <p>10.Śruba_B x8</p>	 <p>11.Klips x8</p>

KROK MONTÁŽU

step 1

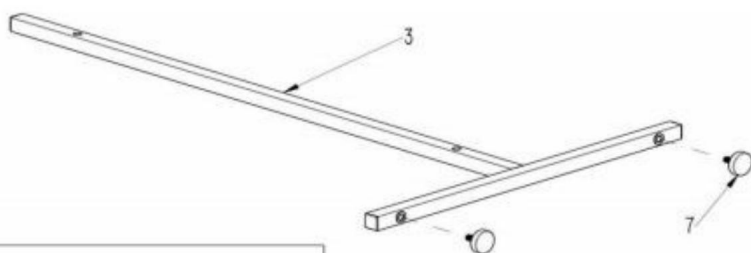

Component 1

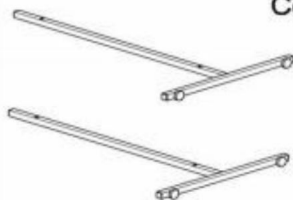

7



X4

krok 2

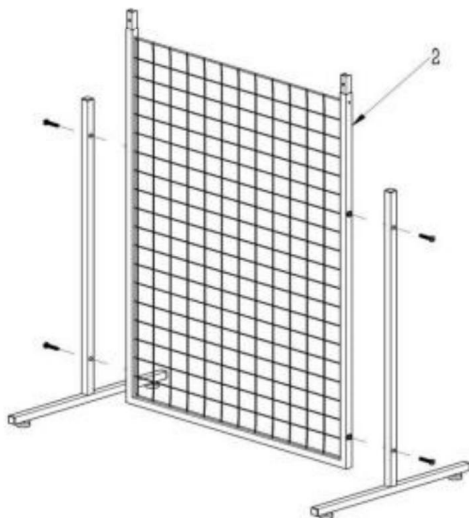

Component 2



10



X4

step 3

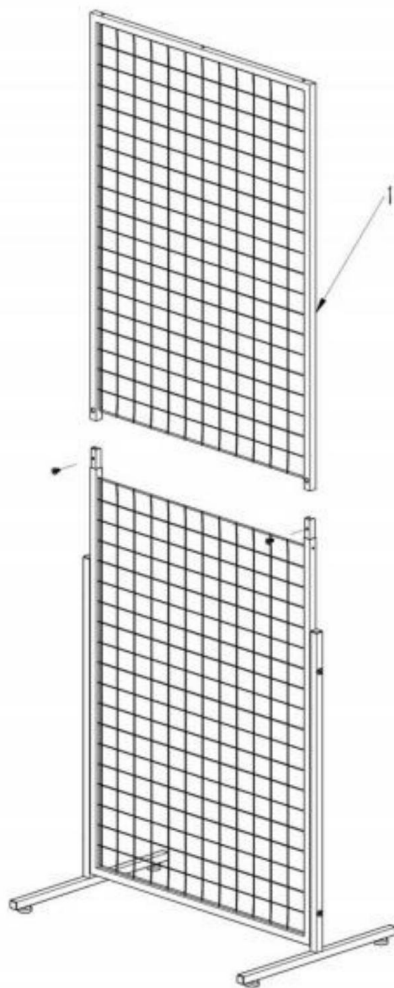

Component 3

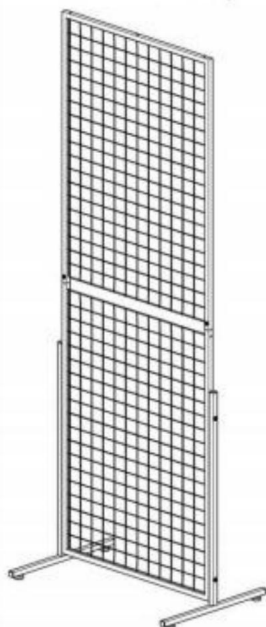

9



X2

step 4

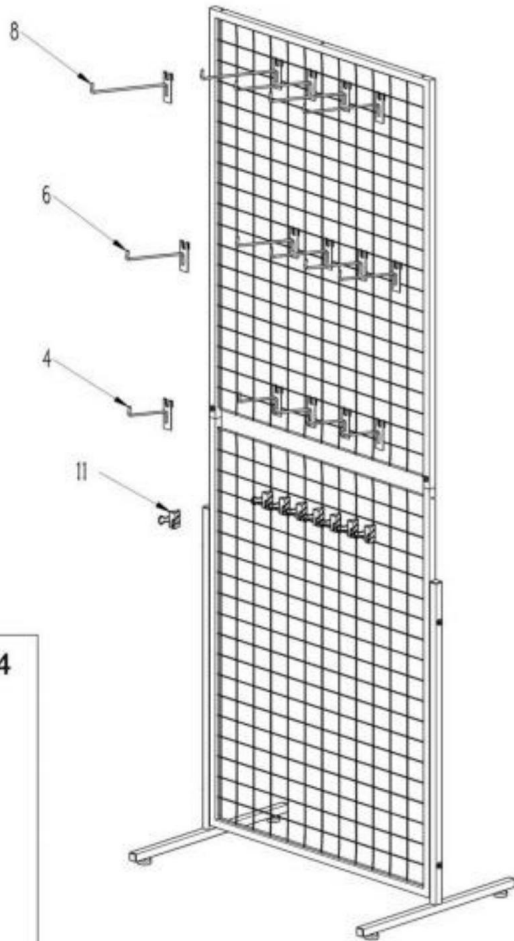

Component 4

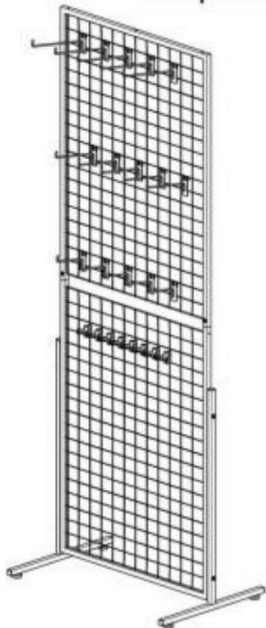

UKOŃCZENIE

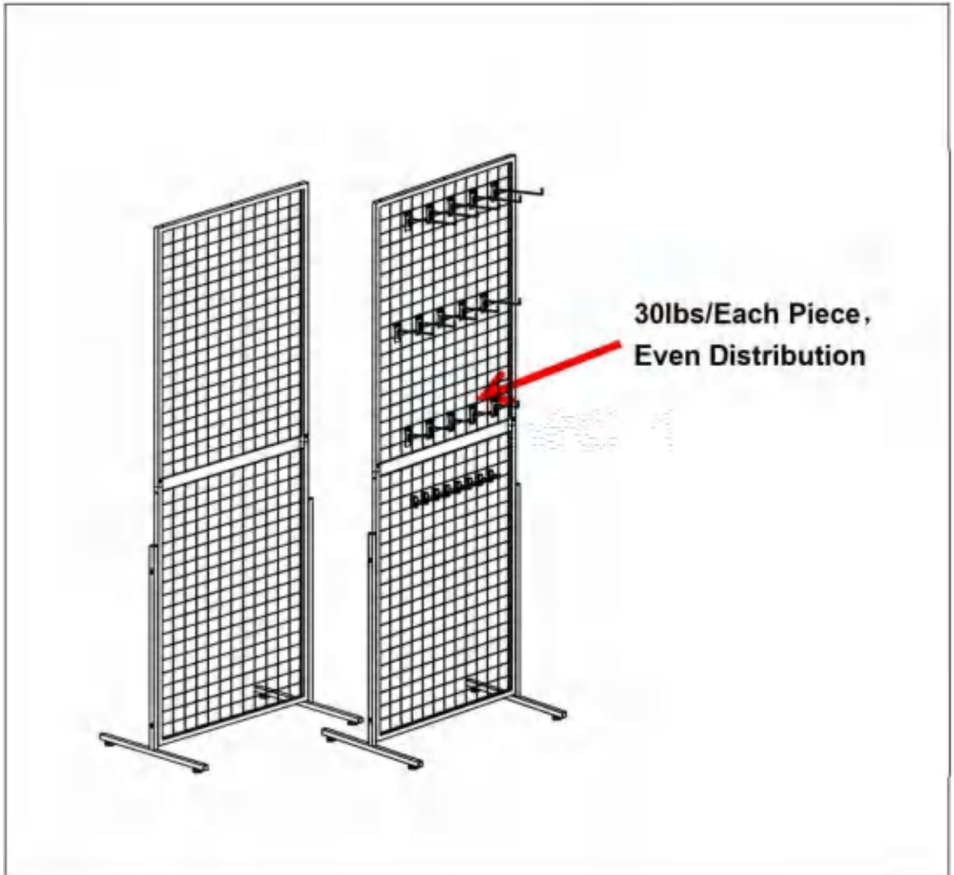

PARAMETR PRODUKTU

Model	YD0024
Waga załadunkowa	30 funtów za sztukę
Rozmiar produktu	1716*617*404 mm /sztuka

Producent: Shanghaimuxinmuyeyouxiangongsi

Adres: Shuangchenglu 803nong11 hao1602A-1609shi,
baoshanqu, Szanghaj 200000 CN.

Importowane do AUS: SIHAO PTY LTD. 1 ROKEVA STREETEAST-WOOD NSW2122
Australia

Importowane do USA: San ven Technology Ltd. Suite 250, 9166 Ana-heim Place, Rancho
Cucamonga, CA91730

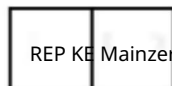

E-CrossStu GmbH
Landstr.69, 60329 Frankfurt nad Menem.



YH CONSULTING LIMITED.
C/O YH Consulting Limited Biuro 147, Centurion House,
London Road, Staines-upon-Thames, Surrey, TW18 4AX

VEVOR[®]

WYTRZYMAŁE NARZĘDZIA, POŁOWA CENY

Wsparcie techniczne i certyfikat e-gwarancji

www.vevor.com/wsparcie

V EN V DER[®]

TOG H NAAROLS, H ALF-P RIJST

Technische ondersteuning en e-garantiecertificaat www.vevor.com/support

ROOSTERWANDEN

GEBRUIKERSHANDLEIDING

MODEL: YD0024

Wij streven er voortdurend naar om u gereedschappen tegen concurrerende prijzen te leveren.

"Bespaar de helft", "halve prijs" of andere soortgelijke uitdrukkingen die wij gebruiken, geven slechts een schatting weer van de besparingen die u kunt behalen door bepaalde gereedschappen bij ons te kopen in vergelijking met de grote topmerken en betekent niet noodzakelijkerwijs dat alle categorieën gereedschappen die wij aanbieden, worden gedekt.

Wij herinneren u eraan om zorgvuldig te controleren of u daadwerkelijk de helft bespaart in vergelijking met de grote topmerken wanneer u een bestelling bij ons plaatst.

VENV DER®

ROOSTERWANDEN

TOG H NAAROLS, H ALF-P RIJST

MODEL:YD0024

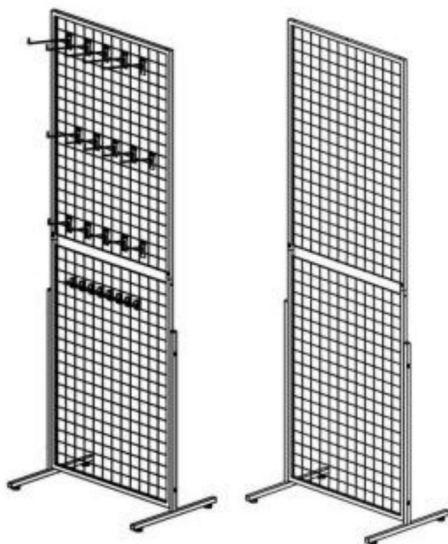

HULP NODIG? NEEM CONTACT MET ONS OP!

Heeft u vragen over het product? Heeft u technische ondersteuning nodig? Neem dan gerust contact met ons op: Technische ondersteuning en E-garantiecertificaat www.vevor.com/support

Dit is de originele instructie, lees alle handleidingen zorgvuldig door voordat u het product gebruikt. VEVOR behoudt zich een duidelijke interpretatie van onze gebruikershandleiding voor. Het uiterlijk van het product is afhankelijk van het product dat u hebt ontvangen. Vergeef ons dat we u niet opnieuw zullen informeren als er technologie- of software-updates voor ons product zijn.

VEILIGHEIDSINSTRUCTIES

WAARSCHUWING:

Lees dit materiaal voordat u dit product gebruikt. Als u dit niet doet, kan dit leiden tot ernstig letsel.

Voorzorgsmaatregelen bij de

- montage** 1. Monteer alleen volgens deze instructies. Onjuiste montage kan gevaren creëren.
2. Draag een ANSI-goedgekeurde veiligheidsbril en stevige werkhandschoenen tijdens de montage.
3. Zorg ervoor dat de verzamelplaats schoon en goed verlicht is.
4. Houd omstanders uit de buurt tijdens de montage.
5. Kom niet bijeen als u moe bent of onder invloed van alcohol, drugs of medicijnen.
6. De producteigenschappen gelden voor correct en volledig gemonteerde producten. alleen producten.
7. Monteer op een vlak, egaal, hard en glad oppervlak dat veilig kan worden gebruikt ter ondersteuning van de Gridwalls.
8. Voor aanvullende informatie over de onderdelen die in de volgende lijst staan vermeld, pagina's, raadpleeg dan het montageschema van deze handleiding. Pak alle onderdelen uit en scheid ze in een schone werkruimte.











Neem

voorzorgsmaatregelen 1. GA NIET OP DIT ITEM ZITTEN OF STAAN.

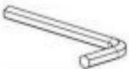
2. Dit product is geen speelgoed. Laat kinderen niet met of in de buurt van dit product spelen. item.
3. Overschrijd het toegestane gewicht niet.
4. Gebruik het alleen op een vlak, egaal, hard en glad oppervlak dat veilig kan worden gebruikt. ondersteuning van een volledig geladen Gridwalls.
5. Gebruik het product alleen zoals bedoeld.
6. Controleer het apparaat voor elk gebruik. Gebruik het apparaat niet als er onderdelen loszitten of beschadigd zijn.

BEWAAR DEZE HANDLEIDING

ONDERDELENLIJST

 <p>1.Top Mesh x2</p>	 <p>2. Bodemgaas x2</p>	
 <p>3.Voetframe x4</p>	 <p>4.Pottenhaak_Klein x5</p>	
 <p>5. Sleutel x1</p>	 <p>6.PotHaak_Midden x5</p>	
 <p>7. Stelvoet x8</p>	 <p>8.Pot Hook_Large x5</p>	
 <p>9.Schroef_A x4</p>	 <p>10.Schroef_B x8</p>	 <p>11.Knip x8</p>

MONTAGESTAP

step 1

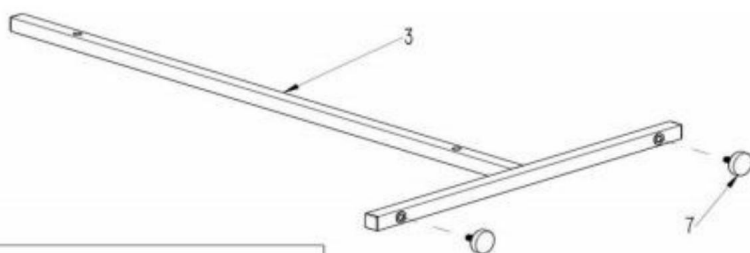

Component 1



7  X4

step 2

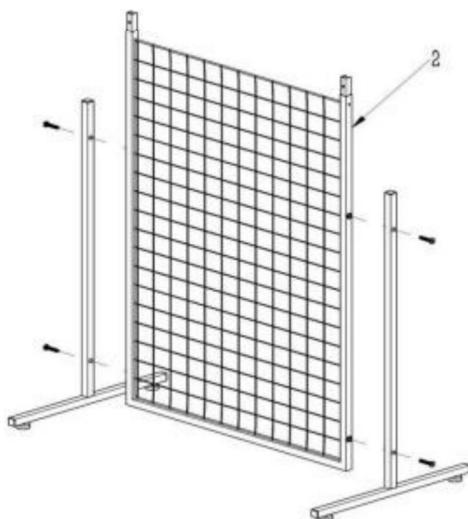

Component 2



10  X4

step 3

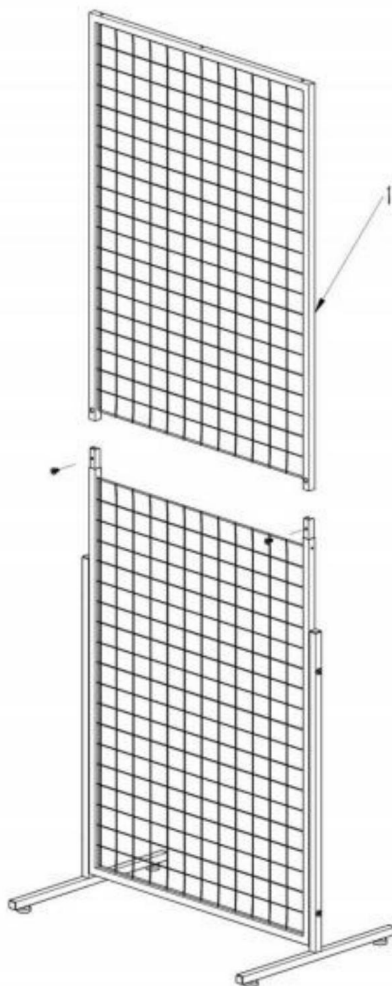

Component 3

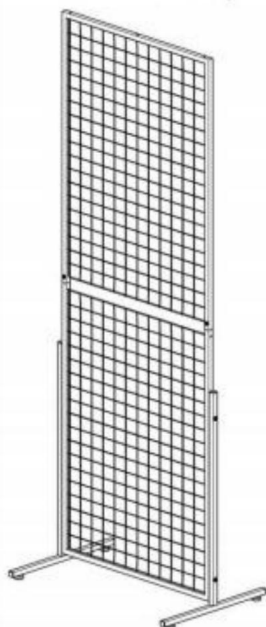

9



X2

step 4

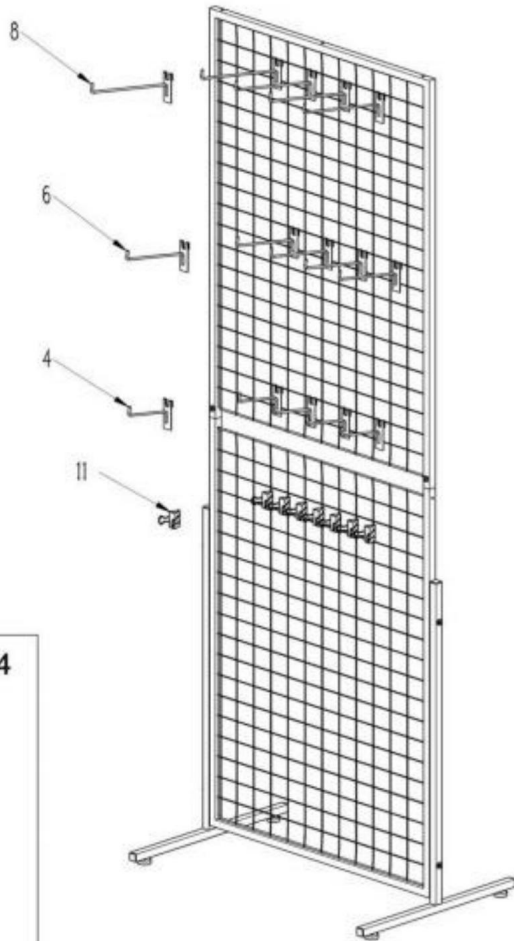

Component 4

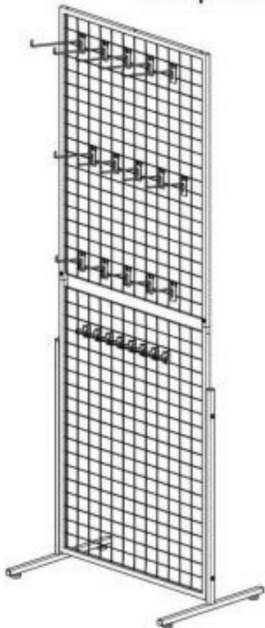

VOLTOOIING



PRODUCTPARAMETER

Model	Jaar 0024
Laadgewicht	30 pond per stuk
Productgrootte	1716*617*404 mm /stuk

Fabrikant: Shanghaimuxinmuyeyouxiangongsi

Adres: Shuangchenglu 803nong11 hao1602A-1609shi,
baoshanqu, sjanghai 200000 CN.

Geïmporteerd naar AUS: SIHAO PTY LTD. 1 ROKEVA STREETEAST-WOOD
NSW2122 Australië

Geïmporteerd naar de VS: San ven Technology Ltd. Suite 250, 9166 Ana-heim Place,
Rancho Cucamonga, CA91730

 E-CrossStu GmbH
Mainzer Landstr.69, 60329 Frankfurt am Main.

 YH CONSULTING LIMITED.
C/O YH Consulting Limited Kantoor 147, Centurion House,
Londen Road, Staines-upon-Thames, Surrey, TW18 4AX

VEVOR[®]

ROBUUSTE GEREEDSCHAPPEN, HALVE PRIJS

Technische ondersteuning en e-garantiecertificaat

www.vevor.com/ondersteuning

V OCH V DER[®]

TUGT H TILLOLS, HALF PRIS

Teknisk support och e-garanticertifikat www.vevor.com/support

GRIDVÄGGAR

ANVÄNDARMANUAL

MODELL:YD0024

Vi fortsätter att vara engagerade i att ge dig verktyg till konkurrenskraftiga priser.

"Spara hälften, "halva priset" eller andra liknande uttryck som används av oss representerar endast en uppskattning av besparingar du kan dra nytta av att köpa vissa verktyg hos oss jämfört med de stora toppmärkena och betyder inte nödvändigtvis att täcka alla kategorier av verktyg som erbjuds av oss Du påminns om att noggrant kontrollera när du lägger en beställning hos oss om du faktiskt sparar hälften i jämförelse med de främsta varumärkena.

VEVOR[®] OCH VEDER[®]

TUGT H TILLOLS, HALF P RIS

GRIDVÄGGAR

MODELL:YD0024

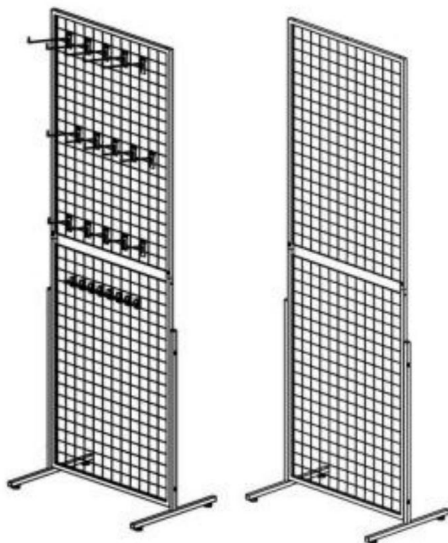

BEHÖVER HJÄLP? KONTAKTA OSS!

Har du produktfrågor? Behöver du teknisk support? Kontakta oss gärna:

Teknisk support och e-garanticertifikat www.vevor.com/support

Detta är den ursprungliga instruktionen, läs alla instruktioner noggrant innan du använder den. VEVOR reserverar sig för en tydlig tolkning av vår användarmanual. Utseendet på produkten är beroende av den produkt du fått. Ursäkta oss att vi inte kommer att informera dig igen om det finns någon teknik eller mjukvaruuppdateringar på vår produkt.

SÄKERHETSINSTRUKTIONER

VARNING:

Läs detta material innan du använder denna produkt. Underlåtenhet att göra det kan resultera i allvarliga skador.

Försiktighetsåtgärder vid











- montering** 1. Montera endast enligt dessa instruktioner. Felaktig montering kan skapa faror.
2. Bär ANSI-godkända skyddsglasögon och kraftiga arbetshandskar under monteringen.
 3. Håll monteringsområdet rent och väl upplyst.
 4. Håll åskådare borta från området under monteringen.
 5. Sätt dig inte ihop när du är trött eller påverkad av alkohol, droger eller mediciner.
 6. Produktens egenskaper gäller för korrekt och fullständigt monterade endast produkter.
 7. Montera på en plan, jämn, hård och slät yta som kan säkert stödja Gridwalls.
 8. För ytterligare information om delarna som anges nedan sidorna, se monteringsdiagrammet i denna manual. Packa upp och separera alla delar på ett rent arbetsområde.

Använd

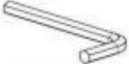
- försiktighetsåtgärder** 1. SIT ELLER STÅ INTE PÅ DETTA FÖREMÅL.
2. Denna produkt är inte en leksak. Låt inte barn leka med eller i närheten av detta punkt.
 3. Överskrid inte viktkapaciteten.
 4. Använd endast på en plan, jämn, hård och slät yta som är säker stöder en fullastad Gridwalls.
 5. Använd endast på avsett sätt.
 6. Inspektera före varje användning; Använd inte om delar är lösa eller skadade.

SPARA DENNA MANUAL

DELLISTA

 <p>1. Top Mesh x2</p>	 <p>2. Bottennät x2</p>	
 <p>3. Fotram x4</p>	 <p>4. Pottkrok_Small x5</p>	
 <p>5. Nyckel x1</p>	 <p>6. Pottkrok_Middle x5</p>	
 <p>7. Nivelleringsfot x8</p>	 <p>8. Pot Hook_Large x5</p>	
 <p>9. Screw_A x4</p>	 <p>10. Screw_B x8</p>	 <p>11. Klipp x8</p>

MONTERINGSTEG

step 1

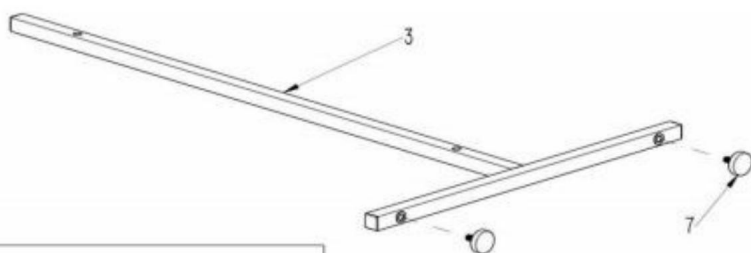

Component 1



7



X4

steg 2

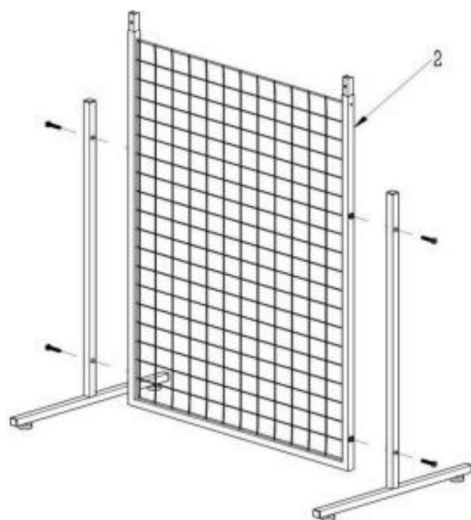

Component 2



10



X4

step 3

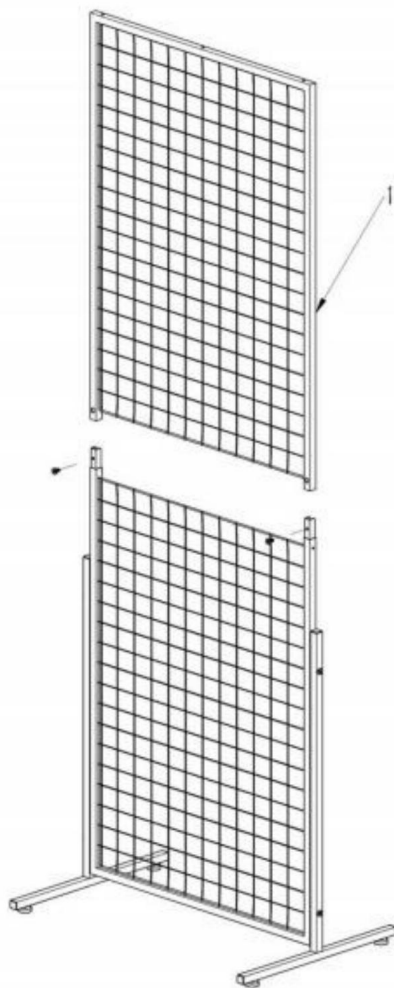

Component 3

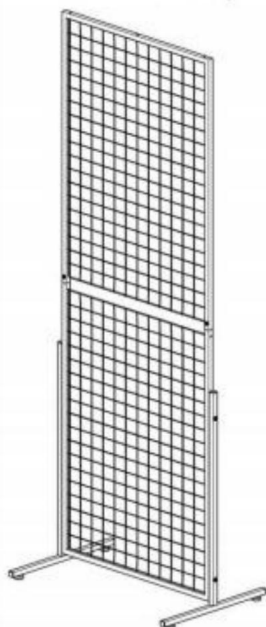

9



X2

step 4

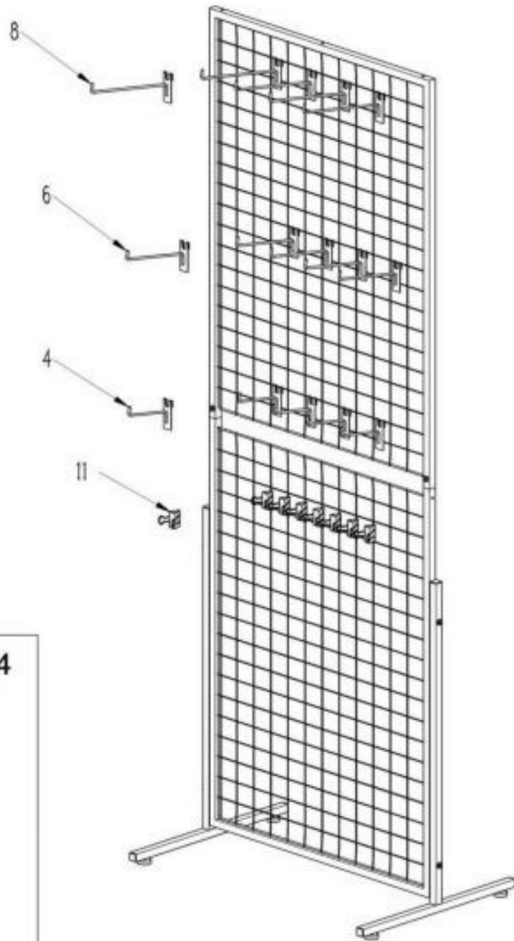

Component 4

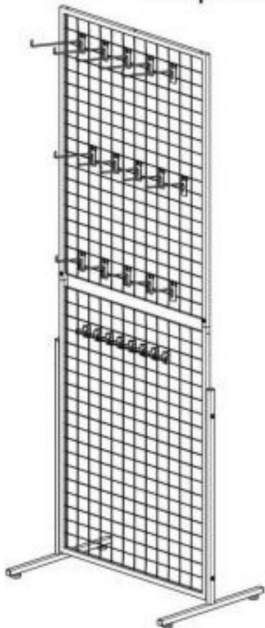

KOMPLETTERING



PRODUKTPARAMETER

Modell	YD0024
Lastvikt	30 lbs per styck
Produktstorlek	1716*617*404 mm /st

Tillverkare: Shanghaimuxinmuyeyouxiangongsi

Adress: Shuangchenglu 803nong11 hao1602A-1609shi,
baoshanqu, shanghai 200000 CN.

Importerad till AUS: SIHAO PTY LTD. 1 ROKEVA STREETEAST-WOOD NSW2122
Australien

Importerad till USA: San ven Technology Ltd. Suite 250, 9166 Ana-heim Place, Rancho
Cucamonga, CA91730

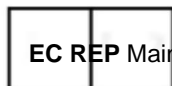

E-CrossStu GmbH
Mainzer Landstr.69, 60329 Frankfurt am Main.



YH CONSULTING LIMITED.
C/O YH Consulting Limited Office 147, Centurion House,
London Road, Staines-upon-Thames, Surrey, TW18 4AX

VEVOR[®]

TÅRA VERKTYG, HALVA PRISET

Teknisk support och e-garanticertifikat

www.vevor.se/support