

# **VEVOR<sup>®</sup>**

## **TOUGH TOOLS, HALF PRICE**

Technical Support and E-Warranty Certificate

[www.vevor.com/support](http://www.vevor.com/support)

### **FISHING CART**

### **MODEL: YK-200**

We continue to be committed to provide you tools with competitive price.

"Save Half", "Half Price" or any other similar expressions used by us only represents an estimate of savings you might benefit from buying certain tools with us compared to the major top brands and does not necessarily mean to cover all categories of tools offered by us. You are kindly reminded to verify carefully when you are placing an order with us if you are actually saving half in comparison with the top major brands.



# VEVOR<sup>®</sup>

TOUGH TOOLS, HALF PRICE

## FISHING CART

MODEL: YK-200



### NEED HELP? CONTACT US!

Have product questions? Need technical support? Please feel free to contact us:

**Technical Support and E-Warranty Certificate**  
**[www.vevor.com/support](http://www.vevor.com/support)**

This is the original instruction, please read all manual instructions carefully before operating. VEVOR reserves a clear interpretation of our user manual. The appearance of the product shall be subject to the product you received. Please forgive us that we won't inform you again if there are any technology or software updates on our product.

## SAFETY INSTRUCTIONS

1. Please confirm that the cart is intact and the tire pressure is normal before each use. Please inflate a little before using the wheels, and be careful not to over-inflate!
2. It is forbidden to carry people under any condition.
3. It is forbidden to load articles on uneven and hilly terrains.
4. Overload is strictly prohibited.
5. Don't move too fast when passing pothole areas.

## MODEL AND PARAMETERS

<b>Model</b>	YK-200
<b>Max. Load</b>	200lbs
<b>Wheels</b>	11inch,inflatable,rubber wheels*2
<b>Fishing Rod Barrel</b>	7
<b>Frame Size (inside)</b>	34 x 14.5 x 7inch
<b>Material</b>	Steel
<b>Color</b>	Black

## STRUCTURE DIAGRAM

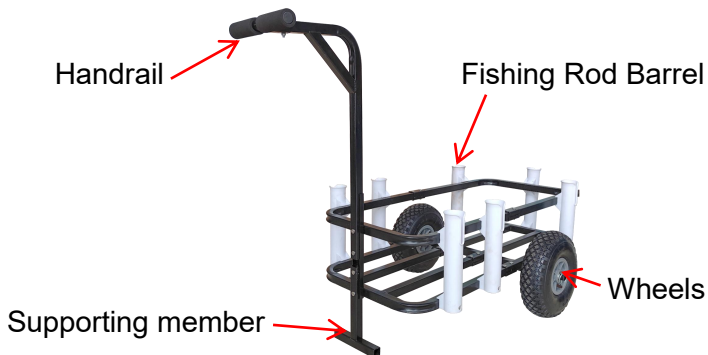

## INSTALLATION

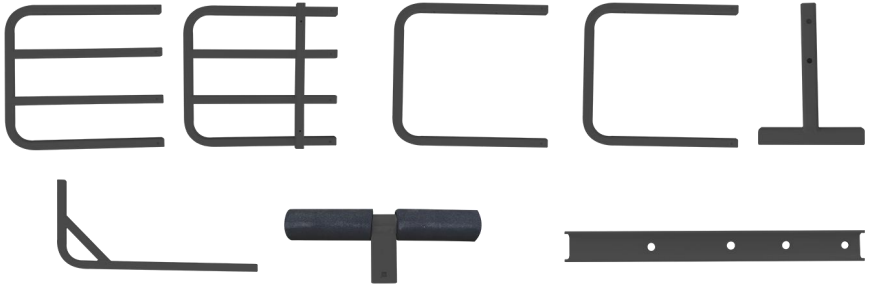

Frame Part x1(Each for one)



Connection Block x12



wheels x2



Washer x2



Axle x2



O-pin x2



Axle Spacer x2



Fishing Rod Barrel x7



Wrench x1



3mm Hex Wrench x1



4mm Hex Wrench x2



M5x35 Bolts x14  
(Need thirteen, one more)



M5x16 Bolts x15  
(Need fourteen, one more)

		
M6x25 Bolts x3 (Need two, one more)	M6x50 Bolts x3 (Need two, one more)	User Manual x1

**Step 1:** Connect the two lower frames together using the M5x35 bolts and the connection block.

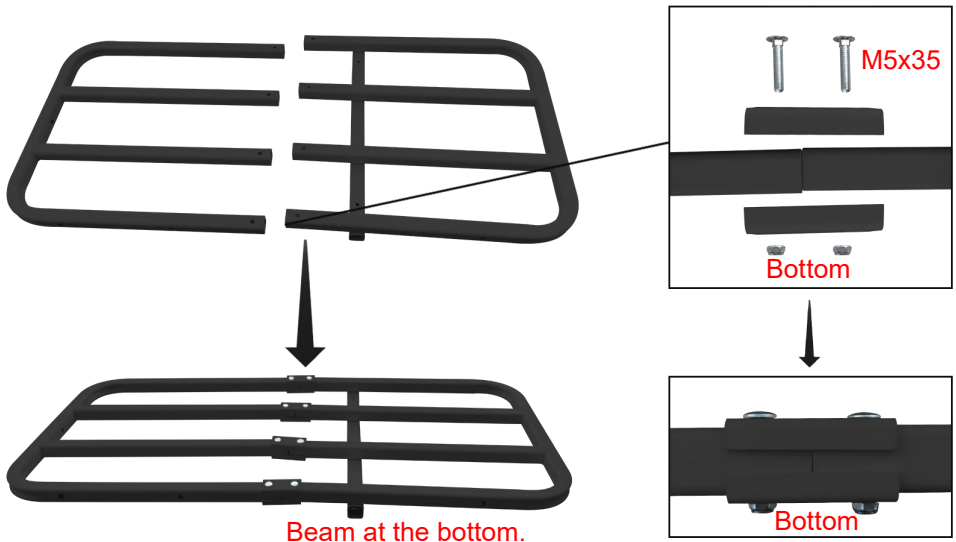

**Step 2:** Attach the upper frame in the same manner.

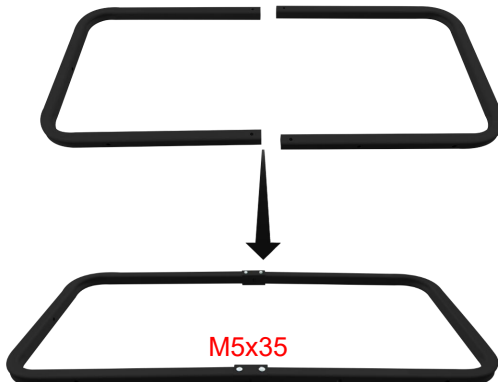

**Step 3:** Mounting the frame.

**NOTE:** The frames have pre-drilled holes for mounting the fishing barrels. The number of pre-drilled holes on the upper and lower frames on the same side should be the same.

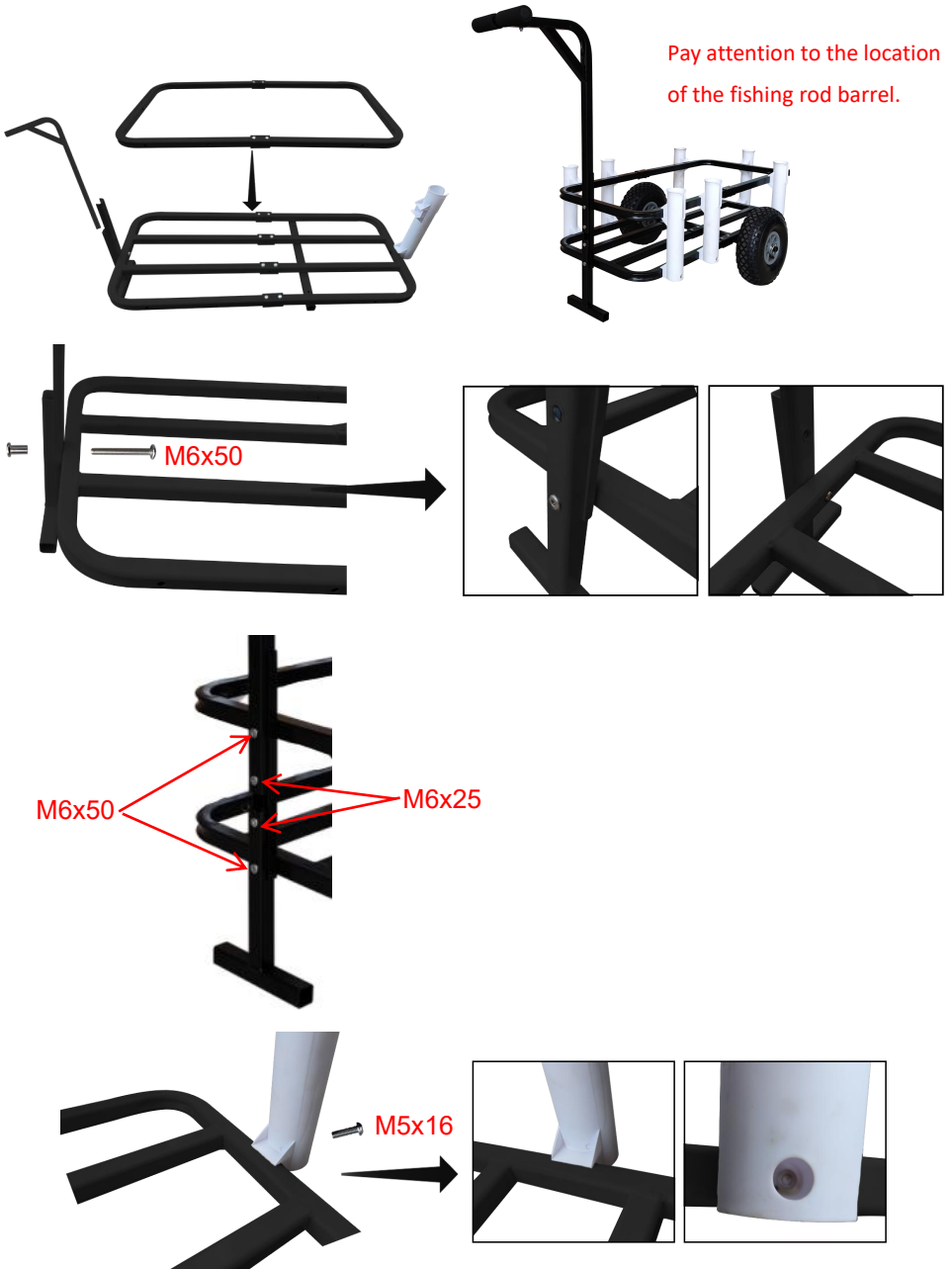

**Step 4:** Install all rod barrels, then wheels.

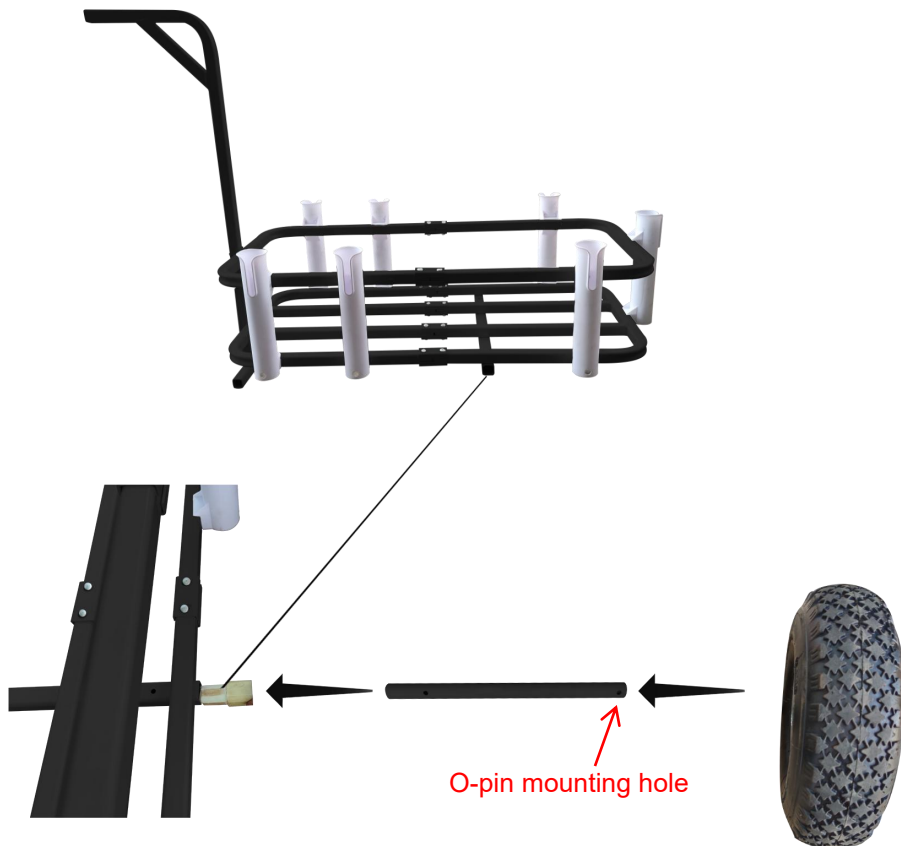

**NOTE:** Insert the plastic parts of the wheel axle into the ends of the bottom cross member of the frame, then insert the wheel axle, and finally install the wheel on it.

**Step 5:** Put in the washer first, then insert the O-pin.







**Step 6:** Installation complete and pump up the tire before use.

## MAINTENANCE

1. Clean the surface after each use.
2. Please confirm that the cart is intact and the tire pressure is normal before each use.
3. Check that the bolts are tight.

**Address:** Baoshanqu Shuangchenglu 803long 11hao 1602A-1609shi  
Shanghai

**Imported to AUS:** SIHAO PTY LTD, 1 ROKEVA STREETEASTWOOD  
NSW 2122 Australia

**Imported to USA:** Sanven Technology Ltd, Suite 250, 9166 Anaheim  
Place, Rancho Cucamonga, CA 91730



SHUNSHUN GmbH  
Römeräcker 9 Z2021, 76351  
Linkenheim-Hochstetten, Germany



Pooledas Group Ltd  
Unit 5 Albert Edward House, The  
Pavilions Preston, United Kingdom

**Made In China**



**VEVOR<sup>®</sup>**

**TOUGH TOOLS, HALF PRICE**

**Technical Support and E-Warranty Certificate**

**[www.vevor.com/support](http://www.vevor.com/support)**

# **VEVOR<sup>®</sup>**

## **TOUGH TOOLS, HALF PRICE**

Assistance technique et certificat de garantie électronique

[www.vevor.com/support](http://www.vevor.com/support)

## **CHARIOT DE PÊCHE**

### **MODÈLE : YK-200**

We continue to be committed to provide you tools with competitive price.

"Save Half", "Half Price" or any other similar expressions used by us only represents an estimate of savings you might benefit from buying certain tools with us compared to the major top brands and does not necessarily mean to cover all categories of tools offered by us. You are kindly reminded to verify carefully when you are placing an order with us if you are actually saving half in comparison with the top major brands.



# VEVOR<sup>®</sup>

TOUGH TOOLS, HALF PRICE

## FISHING CART

MODÈLE : YK-200



### NEED HELP? CONTACT US!

Have product questions? Need technical support? Please feel free to contact us:

**Technical Support and E-Warranty Certificate**  
**[www.vevor.com/support](http://www.vevor.com/support)**

This is the original instruction, please read all manual instructions carefully before operating. VEVOR reserves a clear interpretation of our user manual. The appearance of the product shall be subject to the product you received. Please forgive us that we won't inform you again if there are any technology or software updates on our product.

## SAFETY INSTRUCTIONS

1. Veuillez confirmer que le chariot est intact et que la pression des pneus est normal avant chaque utilisation. Merci de gonfler un peu avant d'utiliser les roues, et attention à ne pas trop gonfler !
2. Il est interdit de transporter des personnes sous quelque condition que ce soit.
3. Il est interdit de charger des articles sur des terrains irréguliers et vallonnés.
4. La surcharge est strictement interdite.
5. Ne vous déplacez pas trop vite lorsque vous passez des zones de nids-de-poule.

## MODEL AND PARAMETERS

<b>Modèle</b>	YK -200
<b>Max. Charger</b>	200 livres
<b>roues</b>	11 pouces, gonflables, roues en
<b>Baril de canne à</b>	7
<b>du cadre (intérieur)</b>	34 x 14,5 x 7 pouces
<b>Matériel</b>	Acier
<b>Couleur</b>	Noir

## STRUCTURE DIAGRAM



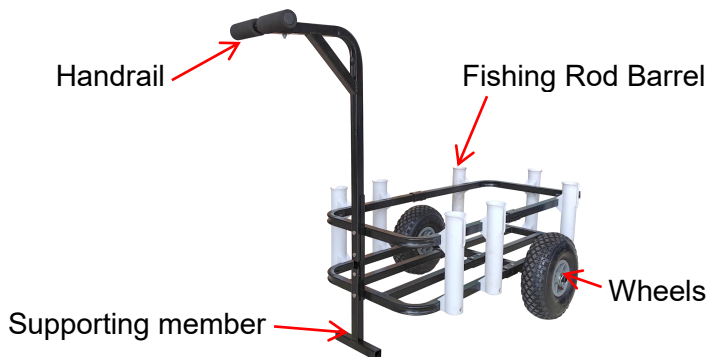

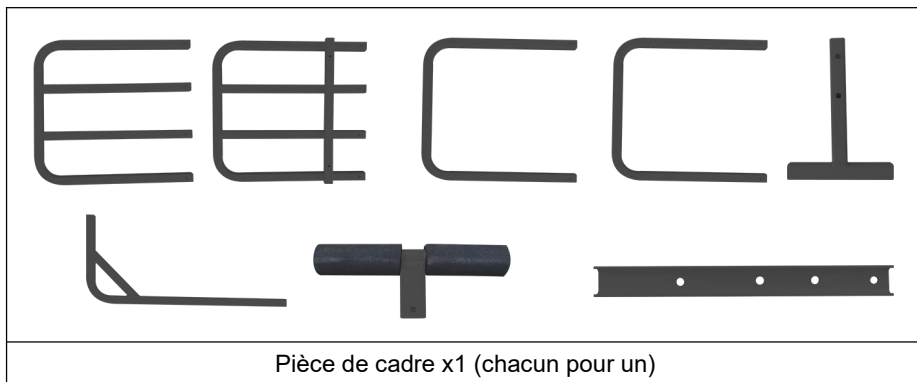

## INSTALLATION



Connexion B lock x12	roues x2	Rondelle x2

Un essieu x 2	O- pin x2	Entretoise d'essieu x2

		
Baril de canne à pêche x 7	Clé _ x1 _	Clé hexagonale de 3 mm x 1

		
Clé hexagonale de 4 mm x 2	Boulons M5x35 x14 (Il en faut treize, un de plus)	Boulons M5x16 x15 (Il en faut quatorze, un de plus)

		
Boulons M6x25 x3 (Il en faut deux, un de plus)	Boulons M6x50 x3 (Il en faut deux, un de plus)	Manuel d'utilisation x1

**Étape 1:** Reliez les deux cadres inférieurs ensemble à l'aide des boulons M5x35 et du bloc de connexion.

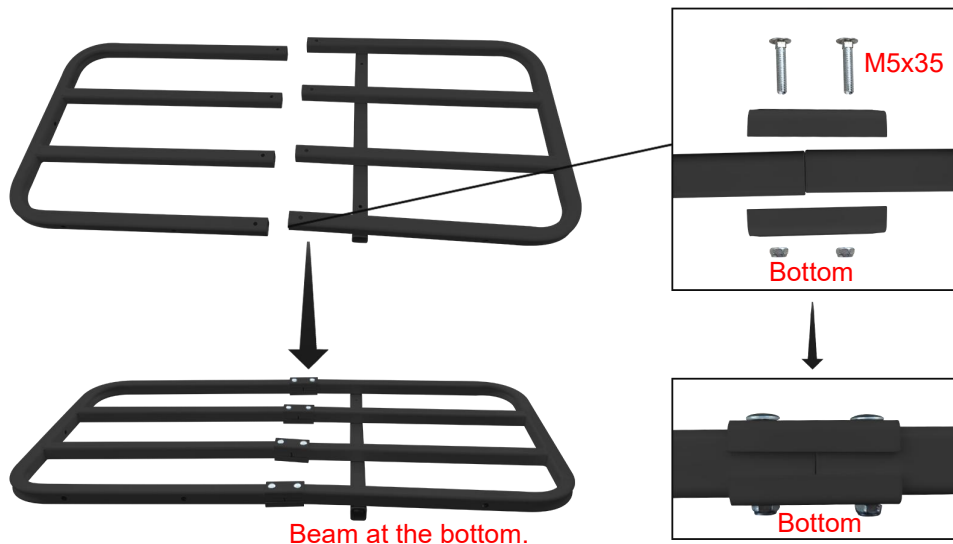

**Étape 2:** Fixez le cadre supérieur de la même manière.

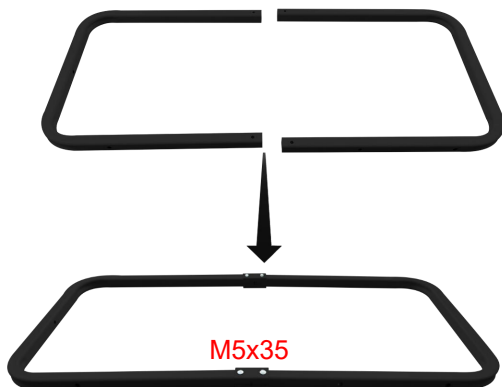

**Étape 3:** Montage du cadre .

**REMARQUE :** Les cadres comportent des trous pré-perçés pour le montage des barils de pêche. Le nombre de trous pré-perçés sur les cadres supérieur et inférieur du même côté doit être le même.

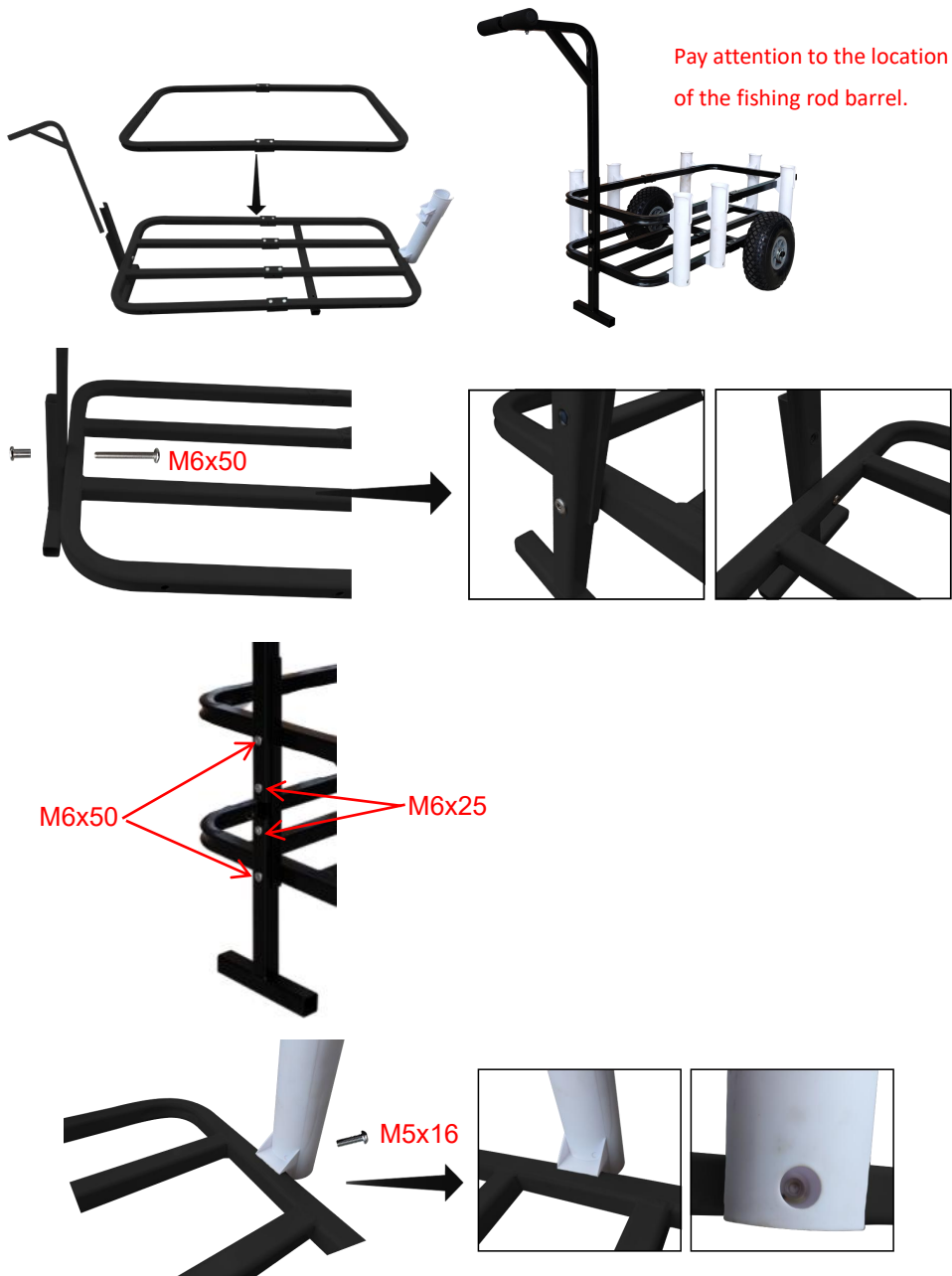

**Étape 4:** Installez tous les barillets de tige, puis les roues .

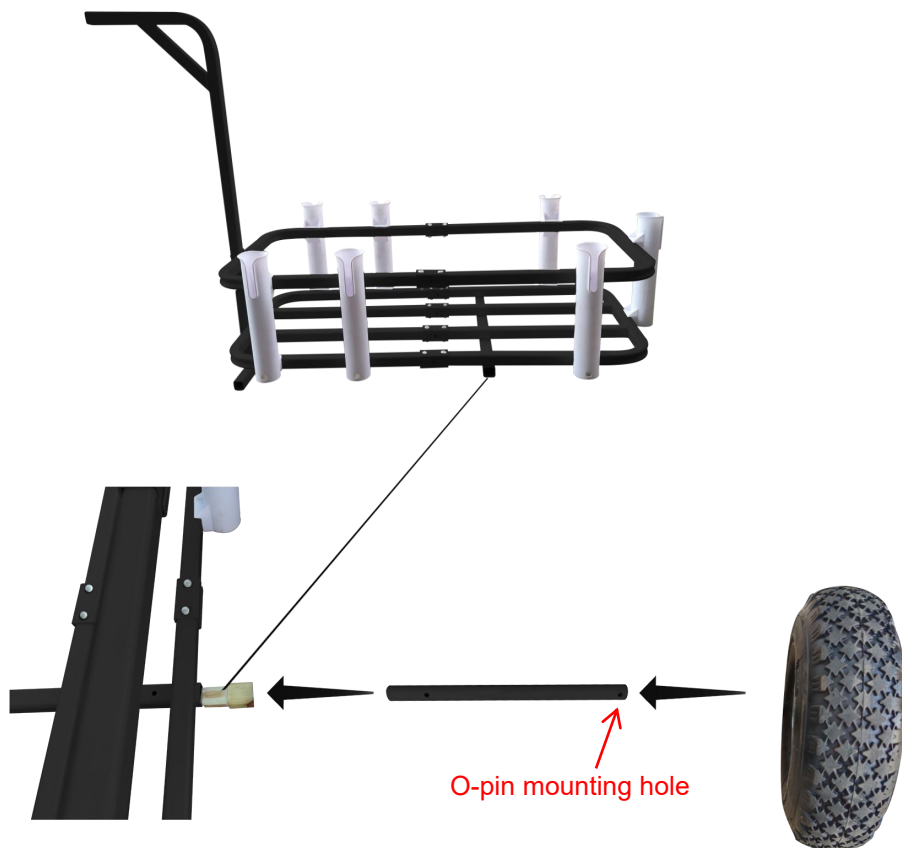

**REMARQUE** : Insérez les pièces en plastique de l'axe de roue dans les extrémités de la traverse inférieure du cadre, puis insérez l'axe de roue et enfin installez la roue dessus.

**Étape 5** : Mettez d'abord la rondelle , puis insérez la goupille O.





**Étape 6** : Installation terminée et gonflez le pneu avant utilisation.

## MAINTENANCE

1. Nettoyez la surface après chaque utilisation.
2. Veuillez confirmer que le chariot est intact et que la pression des pneus est normal avant chaque utilisation.
3. Vérifiez que les boulons sont bien serrés.

**Adresse** : Baoshanqu Shuangchenglu 803long 11hao 1602A-1609shi  
Shanghai

**Importé en Australie** : SIHAO PTY LTD, 1 ROKEVA STREETASTWOOD  
NSW 2122 Australie

**Importé aux États-Unis** : Sanven Technology Ltd, Suite 250, 9166  
Anaheim Place, Rancho Cucamonga, CA 91730



SHUNSHUN GmbH  
Römeräcker 9 Z2021, 76351  
Linkenheim-Hochstetten, Germany



Pooledas Group Ltd  
Unit 5 Albert Edward House, The  
Pavilions Preston, United Kingdom

**Fabriqué en Chine**





**VEVOR**<sup>®</sup>

**TOUGH TOOLS, HALF PRICE**

**Technique Assistance et certificat de garantie électronique**

**[www.vevor.com/support](http://www.vevor.com/support)**

# **VEVOR<sup>®</sup>**

## **TOUGH TOOLS, HALF PRICE**

Zertifikat für technischen Support und E-Garantie

[www.vevor.com/support](http://www.vevor.com/support)

### **ANGELWAGEN**

### **MODELL: YK-200**

We continue to be committed to provide you tools with competitive price.

"Save Half", "Half Price" or any other similar expressions used by us only represents an estimate of savings you might benefit from buying certain tools with us compared to the major top brands and does not necessarily mean to cover all categories of tools offered by us. You are kindly reminded to verify carefully when you are placing an order with us if you are actually saving half in comparison with the top major brands.



# VEVOR®

TOUGH TOOLS, HALF PRICE

## FISHING CART

MODELL: YK-200



### NEED HELP? CONTACT US!

Have product questions? Need technical support? Please feel free to contact us:

**Technical Support and E-Warranty Certificate**  
**[www.vevor.com/support](http://www.vevor.com/support)**

This is the original instruction, please read all manual instructions carefully before operating. VEVOR reserves a clear interpretation of our user manual. The appearance of the product shall be subject to the product you received. Please forgive us that we won't inform you again if there are any technology or software updates on our product.

## SAFETY INSTRUCTIONS

1. Bitte vergewissern Sie sich, dass der Wagen intakt ist und der Reifendruck stimmt normal vor jedem Gebrauch. Bitte pumpen Sie die Räder ein wenig auf, bevor Sie sie verwenden, und achten Sie darauf, nicht zu viel aufzupumpen !
2. Es ist unter allen Umständen verboten, Personen zu befördern.
3. Das Verladen von Gegenständen auf unebenem und hügeligem Gelände ist verboten.
4. Überlastung ist strengstens untersagt.
5. Fahren Sie nicht zu schnell, wenn Sie an Schlaglochstellen vorbeifahren.

## MODEL AND PARAMETERS

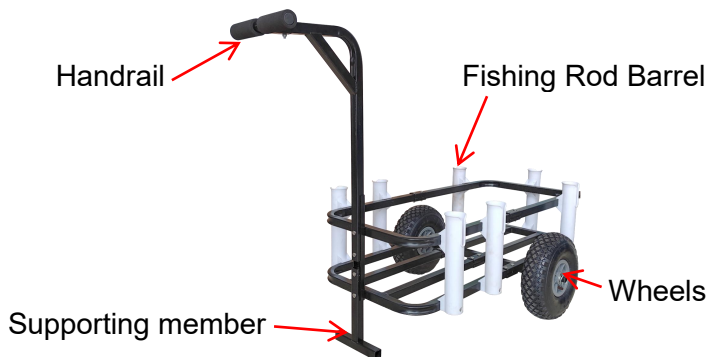

<b>Modell</b>	YK- 200
<b>Max. Belastung</b>	200 Pfund
<b>Räder</b>	11 Zoll, aufblasbar, Gummiräder*2
<b>Angelrutenfass</b>	7
<b>Rahmengröße</b>	34 x 14,5 x 7 Zoll
<b>Material</b>	Stahl
<b>Farbe</b>	Schwarz

## STRUCTURE DIAGRAM



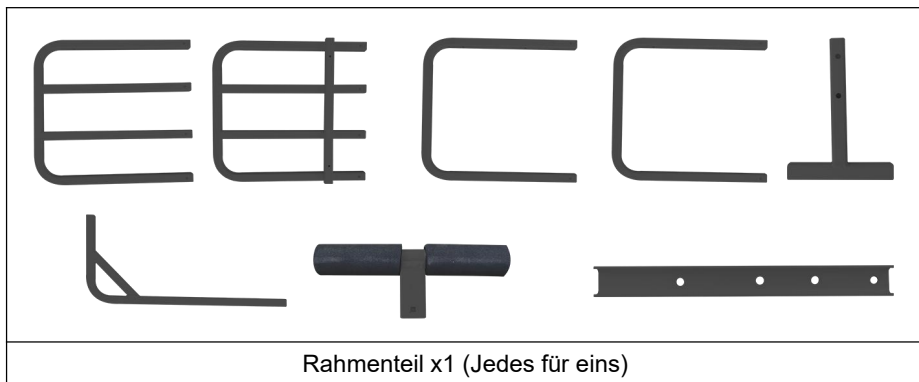

## INSTALLATION



		
Anschluss B - Sperre x12	Räder x2	Unterlegscheibe x2

		
Eine xle x 2	O- Pin x2	Achsabstandshalter x2

		
Angelrutenfass x 7	Schraubenschlüssel _ x 1	3 mm Sechskantschlüssel x 1

		
4-mm- Inbusschlüssel x 2	M5x35 Schrauben x14 (Brauchen dreizehn, noch eins)	M5x16 Schrauben x15 (Brauchen vierzehn, noch eins)

		
M6x25 Schrauben x3 (Brauchen zwei, noch eins)	M6x50 Schrauben x3 (Brauchen zwei, noch eins)	Benutzerhandbuch x1

**Schritt 1:** Verbinden Sie die beiden unteren Rahmen mit den M5x35-Schrauben und dem Verbindungsblock miteinander.

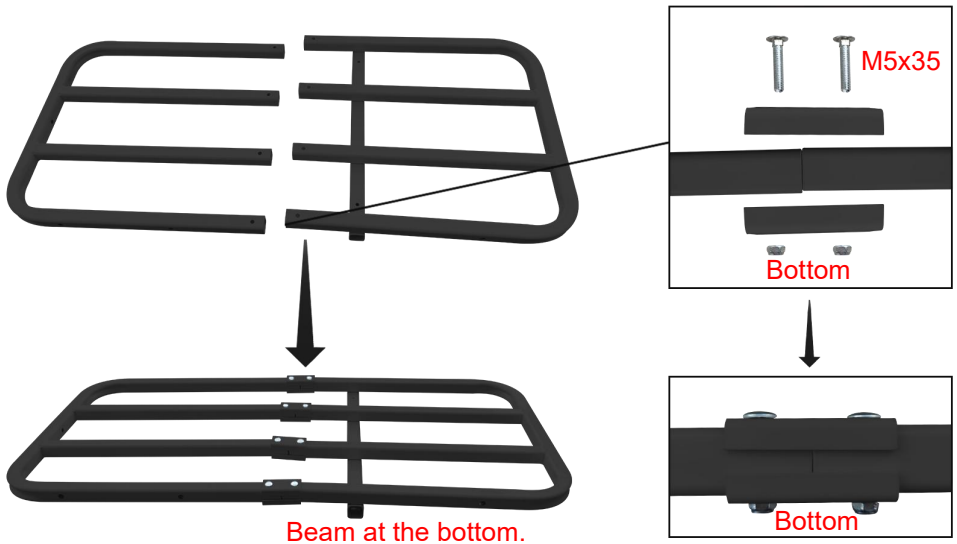

**Schritt 2:** Befestigen Sie den oberen Rahmen auf die gleiche Weise.

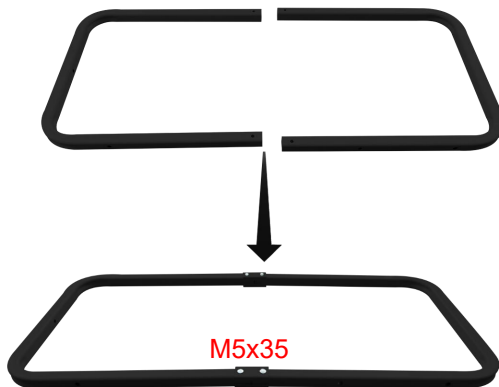

**Schritt 3:** Montage des Rahmens .

**HINWEIS:** Die Rahmen verfügen über vorgebohrte Löcher zur Montage der Angelfässer. Die Anzahl der vorgebohrten Löcher am oberen und unteren Rahmen auf derselben Seite sollte gleich sein.



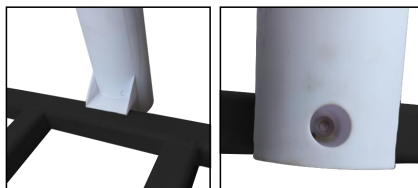
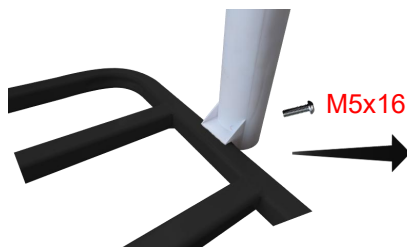
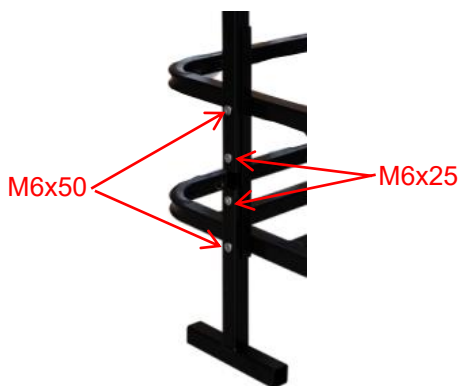
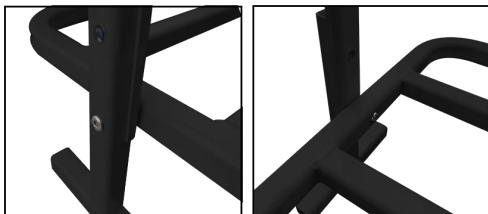

**Schritt 4:** Montieren Sie alle Stangenläufe und dann die Räder .

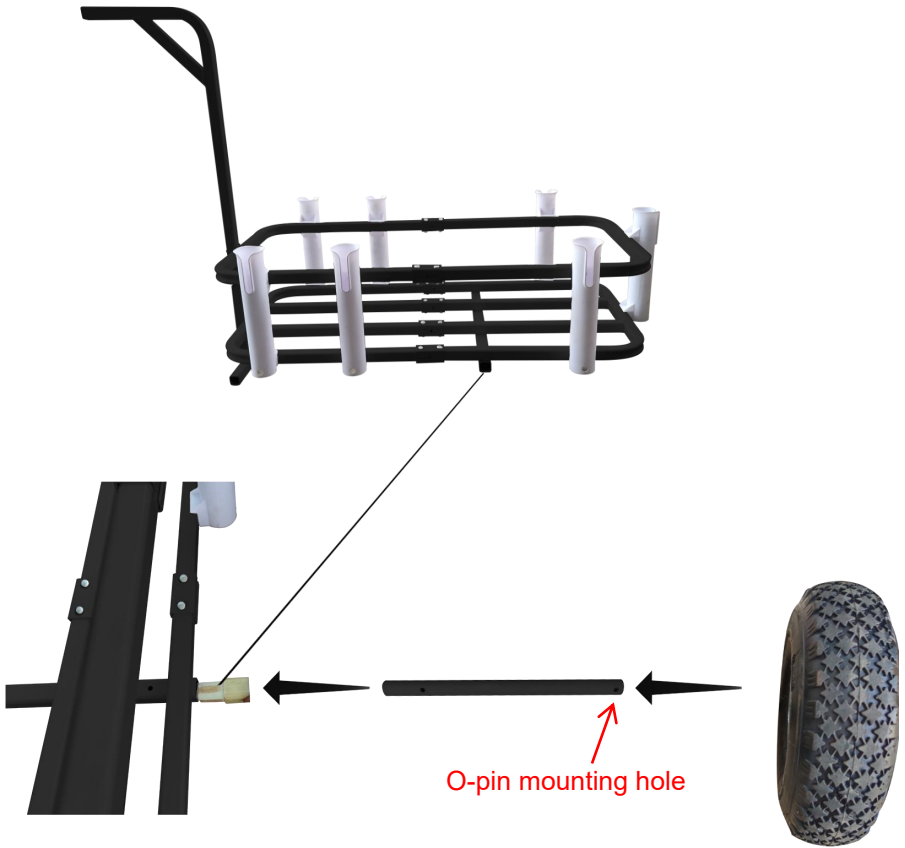

**HINWEIS:** Stecken Sie die Kunststoffteile der Radachse in die Enden des unteren Querträgers des Rahmens, setzen Sie dann die Radachse ein und montieren Sie schließlich das Rad darauf.

**Schritt 5:** Setzen Sie zuerst die Unterlegscheibe ein und setzen Sie dann den O- Stiff ein.





**Schritt 6:** Die Installation abschließen und den Reifen vor dem Gebrauch aufpumpen.

## MAINTENANCE

1. Reinigen Sie die Oberfläche nach jedem Gebrauch.
2. Bitte bestätigen Sie, dass der Wagen intakt ist und der Reifendruck stimmt normal vor jedem Gebrauch.
3. Überprüfen Sie, ob die Schrauben fest angezogen sind.

**Adresse:** Baoshanqu Shuangchenglu 803long 11hao 1602A-1609shi  
Shanghai

**Importiert nach AUS:** SIHAO PTY LTD, 1 ROKEVA STREETEASTWOOD  
NSW 2122 Australien

**In die USA importiert:** Sanven Technology Ltd, Suite 250, 9166 Anaheim  
Place, Rancho Cucamonga, CA 91730

<b>EC</b>	<b>REP</b>
-----------	------------

SHUNSHUN GmbH  
Römeräcker 9 Z2021, 76351  
Linkenheim-Hochstetten, Germany

<b>UK</b>	<b>REP</b>
-----------	------------

Pooledas Group Ltd  
Unit 5 Albert Edward House, The  
Pavilions Preston, United Kingdom

**In China hergestellt**



**VEVOR**<sup>®</sup>

**TOUGH TOOLS, HALF PRICE**

**Technisch Support- und E-Garantiezertifikat**

**[www.vevor.com/support](http://www.vevor.com/support)**

# **VEVOR<sup>®</sup>**

## **TOUGH TOOLS, HALF PRICE**

Supporto tecnico e certificato di garanzia elettronica

[www.vevor.com/support](http://www.vevor.com/support)

## **CARRELLO DA PESCA**

### **MODELLO: YK-200**

We continue to be committed to provide you tools with competitive price.

"Save Half", "Half Price" or any other similar expressions used by us only represents an estimate of savings you might benefit from buying certain tools with us compared to the major top brands and does not necessarily mean to cover all categories of tools offered by us. You are kindly reminded to verify carefully when you are placing an order with us if you are actually saving half in comparison with the top major brands.





# VEVOR®

TOUGH TOOLS, HALF PRICE

## FISHING CART

MODELLO: YK-200



### NEED HELP? CONTACT US!

Have product questions? Need technical support? Please feel free to contact us:

**Technical Support and E-Warranty Certificate**  
**[www.vevor.com/support](http://www.vevor.com/support)**

This is the original instruction, please read all manual instructions carefully before operating. VEVOR reserves a clear interpretation of our user manual. The appearance of the product shall be subject to the product you received. Please forgive us that we won't inform you again if there are any technology or software updates on our product.

## SAFETY INSTRUCTIONS

1. Confermare che il carrello sia intatto e che la pressione dei pneumatici lo sia normale prima di ogni utilizzo. Si prega di gonfiare un po' prima di utilizzare le ruote e fare attenzione a non gonfiare eccessivamente !
2. È vietato trasportare persone in qualsiasi condizione.
3. È vietato caricare articoli su terreni sconnessi e collinari.
4. Il sovraccarico è severamente vietato.
5. Non muoverti troppo velocemente quando attraversi aree con buche.

## MODEL AND PARAMETERS



<b>Modello</b>	YK -200
<b>Massimo. Carico</b>	200 libbre
<b>Ruote</b>	Ruote in gomma da 11 pollici, gonfiabili
<b>Canna da pesca</b>	7
<b>Dimensioni cornice</b>	34 x 14,5 x 7 pollici
<b>Materiale</b>	Acciaio
<b>Colore</b>	Nero

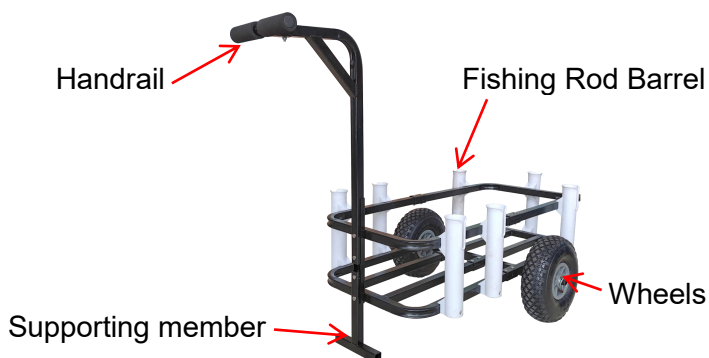

## STRUCTURE DIAGRAM

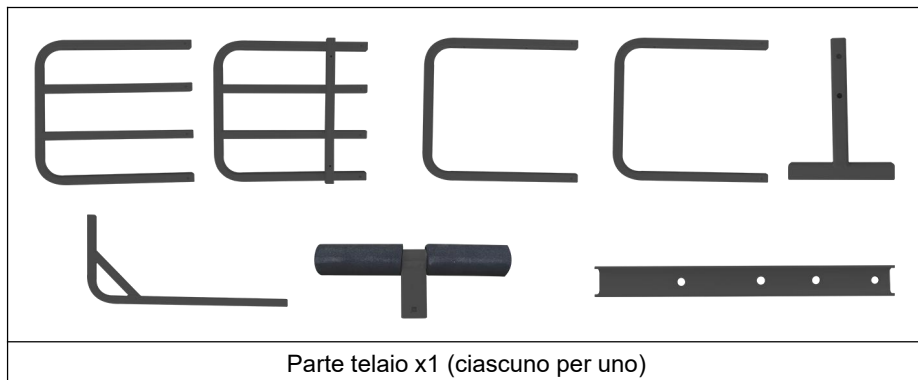



## INSTALLATION



		
Blocco connessione B x12	ruotex2	Rondella x2

		
Un asse x 2	O- pin x2	Distanziatore dell'asse x2

		
Canna da pesca x 7	Wrench x1 _	Chiave esagonale da 3 mm x 1

		
---	---	---

Chiave esagonale da 4 mm x 2	Bulloni M5x35 x14 (Ne servono tredici, uno in più)	Bulloni M5x16x15 (Ne servono quattordici, uno in più)
------------------------------	---	--

		
Bulloni M6x25x3 (Ne servono due, uno in più)	Bulloni M6x50x3 (Ne servono due, uno in più)	Manuale utente x1

**Passo 1:** Collegare insieme i due telai inferiori utilizzando i bulloni M5x35 e il blocco di connessione.

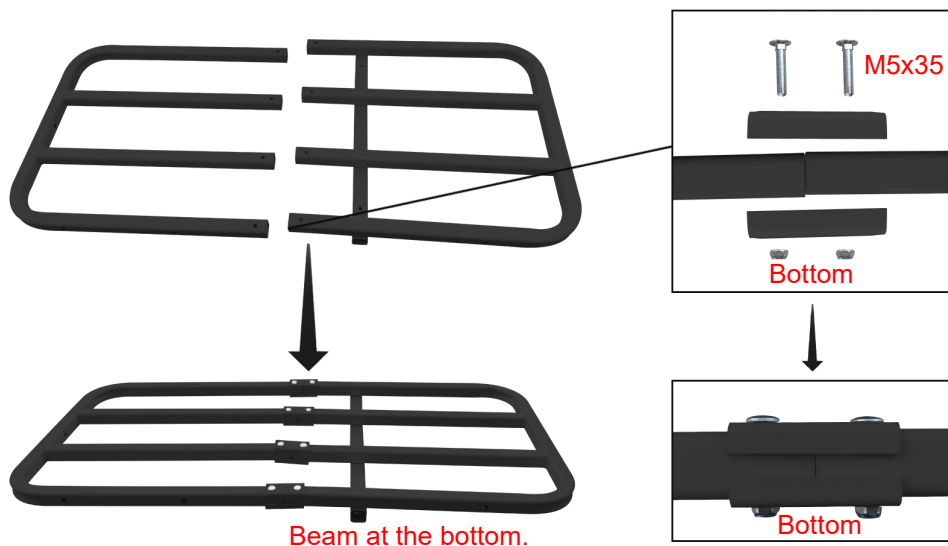

**Passo 2:** Fissare il telaio superiore allo stesso modo.

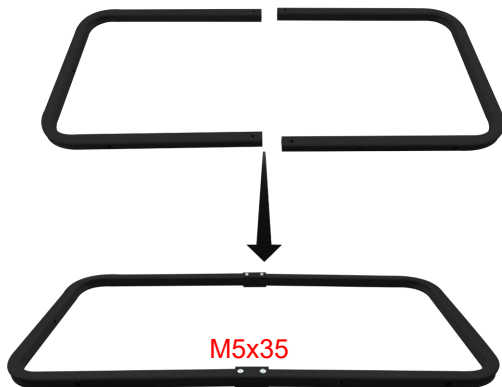

**Passaggio 3:** Montaggio del telaio .

**NOTA:** i telai sono dotati di fori predisposti per il montaggio delle canne da pesca. Il numero di fori preforati sui telai superiore e inferiore sullo stesso lato deve essere lo stesso.

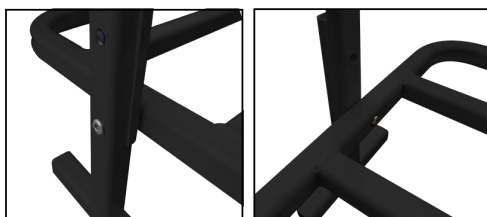

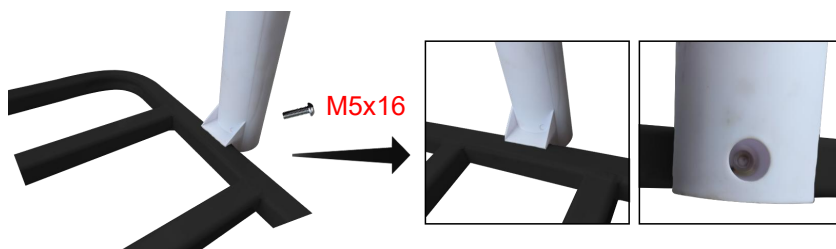
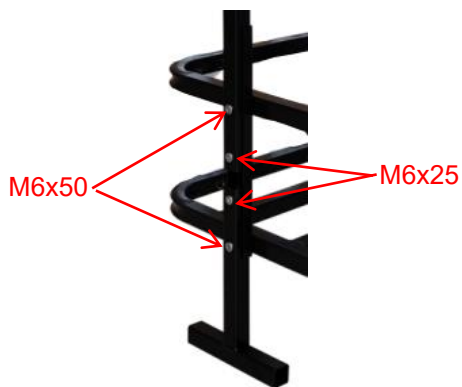

**Passaggio 4:** Installare tutti i cilindri delle aste, quindi le ruote .

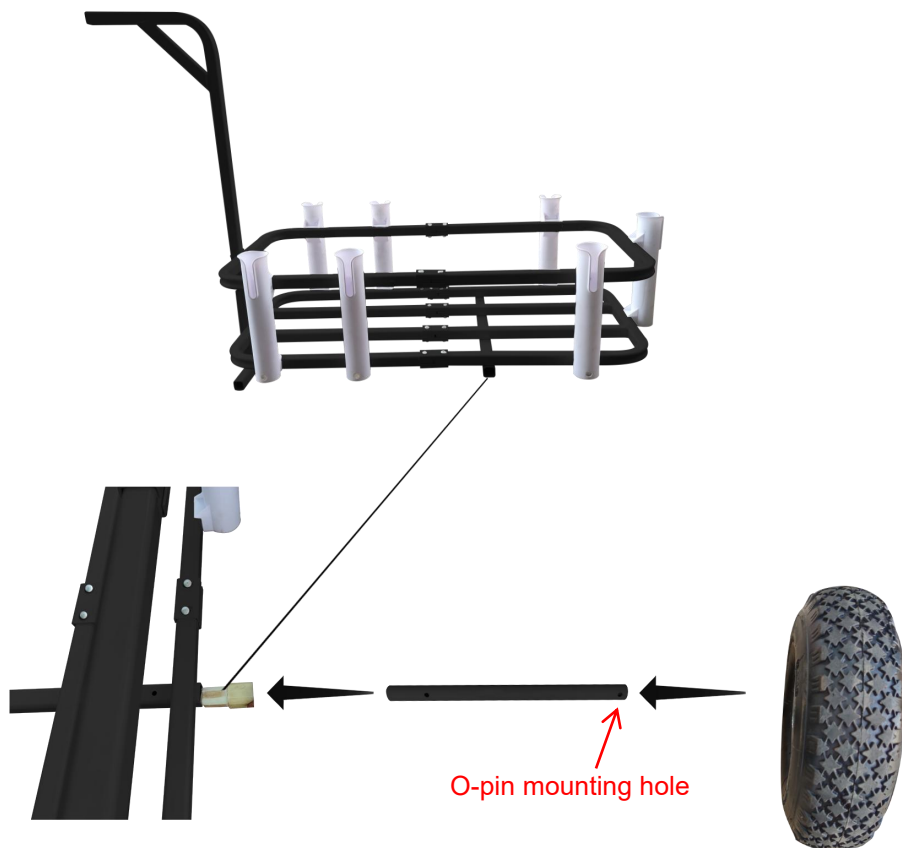

**NOTA:** inserire le parti in plastica dell'asse della ruota nelle estremità della traversa inferiore del telaio, quindi inserire l'asse della ruota e infine installare la ruota su di esso.

**Passaggio 5:** Inserire prima la rondella , quindi inserire l' O- pin.





**Passaggio 6:** installazione completata e gonfiare il pneumatico prima dell'uso.

## MAINTENANCE

1. Pulire la superficie dopo ogni utilizzo.
2. Confermare che il carrello sia intatto e che la pressione dei pneumatici lo sia normale prima di ogni utilizzo.
3. Controllare che i bulloni siano serrati.



**Indirizzo:** Baoshanqu Shuangchenglu 803long 11hao 1602A-1609shi  
Shanghai

**Importato in AUS:** SIHAO PTY LTD, 1 ROKEVA STREETEASTWOOD  
NSW 2122 Australia

**Importato negli Stati Uniti:** Sanven Technology Ltd, Suite 250, 9166  
Anaheim Place, Rancho Cucamonga, CA 91730



SHUNSHUN GmbH  
Römeräcker 9 Z2021, 76351  
Linkenheim-Hochstetten, Germany



Pooledas Group Ltd  
Unit 5 Albert Edward House, The  
Pavilions Preston, United Kingdom

**Made in China**



**VEVOR**<sup>®</sup>

**TOUGH TOOLS, HALF PRICE**

**Tecnico Supporto e certificato di garanzia elettronica**

**[www.vevor.com/support](http://www.vevor.com/support)**

# **VEVOR<sup>®</sup>**

## **TOUGH TOOLS, HALF PRICE**

Soporte técnico y certificado de garantía electrónica

[www.vevor.com/support](http://www.vevor.com/support)

## **CARRO DE PESCA**

### **MODELO: YK-200**

We continue to be committed to provide you tools with competitive price.

"Save Half", "Half Price" or any other similar expressions used by us only represents an estimate of savings you might benefit from buying certain tools with us compared to the major top brands and does not necessarily mean to cover all categories of tools offered by us. You are kindly reminded to verify carefully when you are placing an order with us if you are actually saving half in comparison with the top major brands.



# VEVOR®

TOUGH TOOLS, HALF PRICE

## FISHING CART

MODELO: YK-200



### NEED HELP? CONTACT US!

Have product questions? Need technical support? Please feel free to contact us:

**Technical Support and E-Warranty Certificate**  
**[www.vevor.com/support](http://www.vevor.com/support)**

This is the original instruction, please read all manual instructions carefully before operating. VEVOR reserves a clear interpretation of our user manual. The appearance of the product shall be subject to the product you received. Please forgive us that we won't inform you again if there are any technology or software updates on our product.

## SAFETY INSTRUCTIONS

1. Confirme que el carrito esté intacto y que la presión de los neumáticos sea normal antes de cada uso. Infle un poco antes de usar las ruedas y tenga cuidado de no inflar demasiado .
2. Está prohibido transportar personas bajo cualquier condición.
3. Está prohibido cargar artículos en terrenos irregulares y montañosos.
4. La sobrecarga está estrictamente prohibida.
5. No se mueva demasiado rápido al pasar por zonas con baches.

## MODEL AND PARAMETERS

<b>Modelo</b>	YK -200
<b>Máx. Carga</b>	200 libras
<b>Ruedas</b>	Ruedas de goma inflables de 11
<b>Barril de caña de</b>	7
<b>Tamaño del marco</b>	34 x 14,5 x 7 pulgadas
<b>Material</b>	Acero
<b>Color</b>	Negro

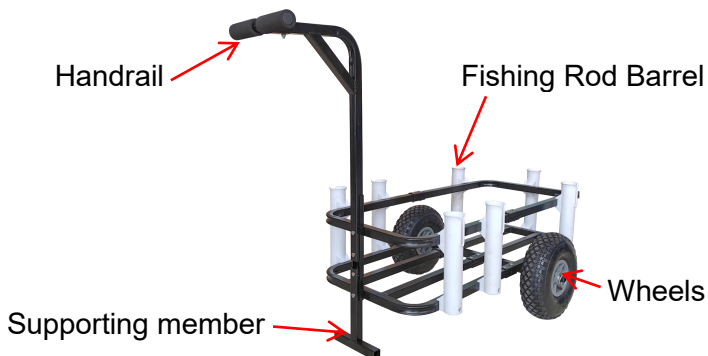

## STRUCTURE DIAGRAM



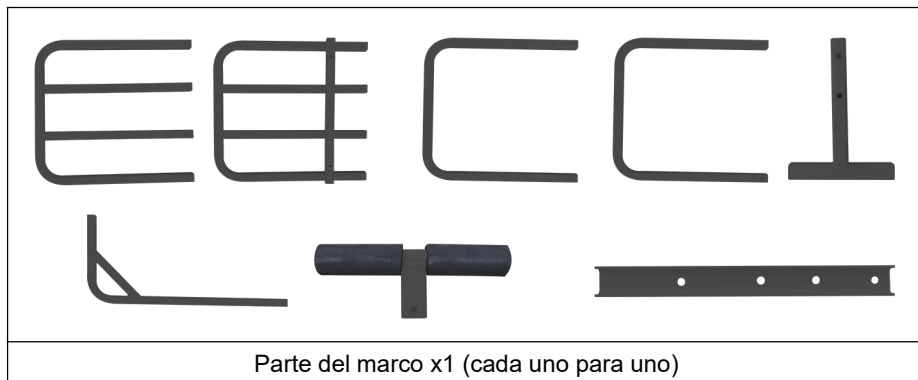

## INSTALLATION



		
Bloqueo de conexión x12	ruedas x2	Lavadora x2

		
Un eje x 2	O- pin x2	Espaciador del eje x2

		
Barril de caña de pescar x 7	llave inglesa x1 _	1 llave hexagonal de 3 mm .

		
2 llaves hexagonales de 4 mm .	Pernos M5x35 x14 (Necesita trece, uno más)	Pernos M5x16 x15 (Necesita catorce, uno



		más)
--	--	------

		
Pernos M6x25 x3 (Necesito dos, uno más)	Pernos M6x50 x3 (Necesito dos, uno más)	Manual de usuario x1

**Paso 1:** Conecte los dos marcos inferiores entre sí utilizando los pernos M5x35 y el bloque de conexión.

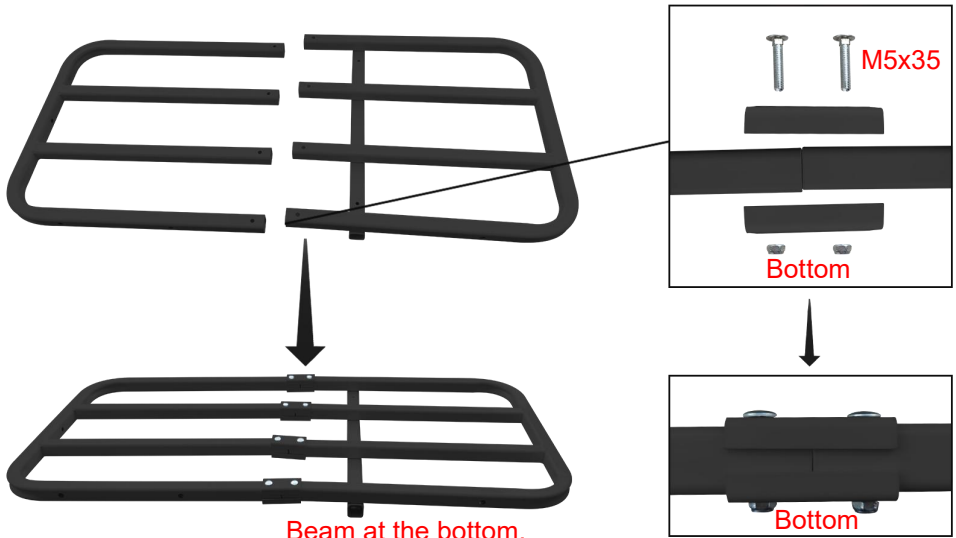

**Paso 2:** Fije el marco superior de la misma manera.

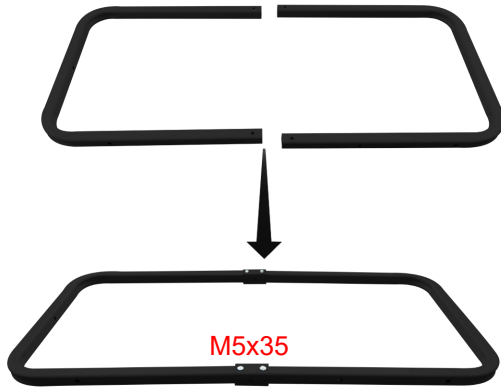

**Paso 3:** Montaje del marco .

**NOTA:** Los marcos tienen orificios pretaladrados para montar los barriles de pesca. El número de orificios previamente perforados en los marcos superior e inferior del mismo lado debe ser el mismo.



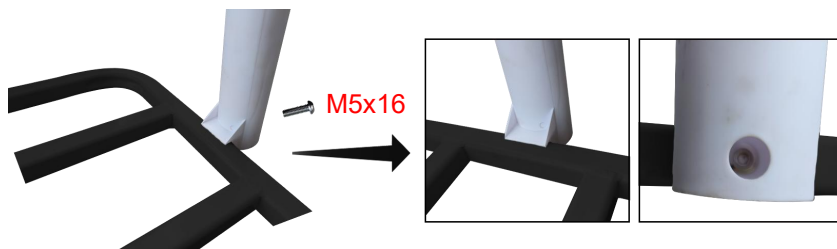
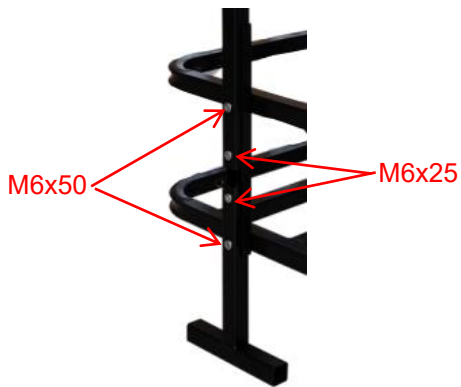

**Etapa 4:** Instale todos los cilindros de las varillas y luego las ruedas .

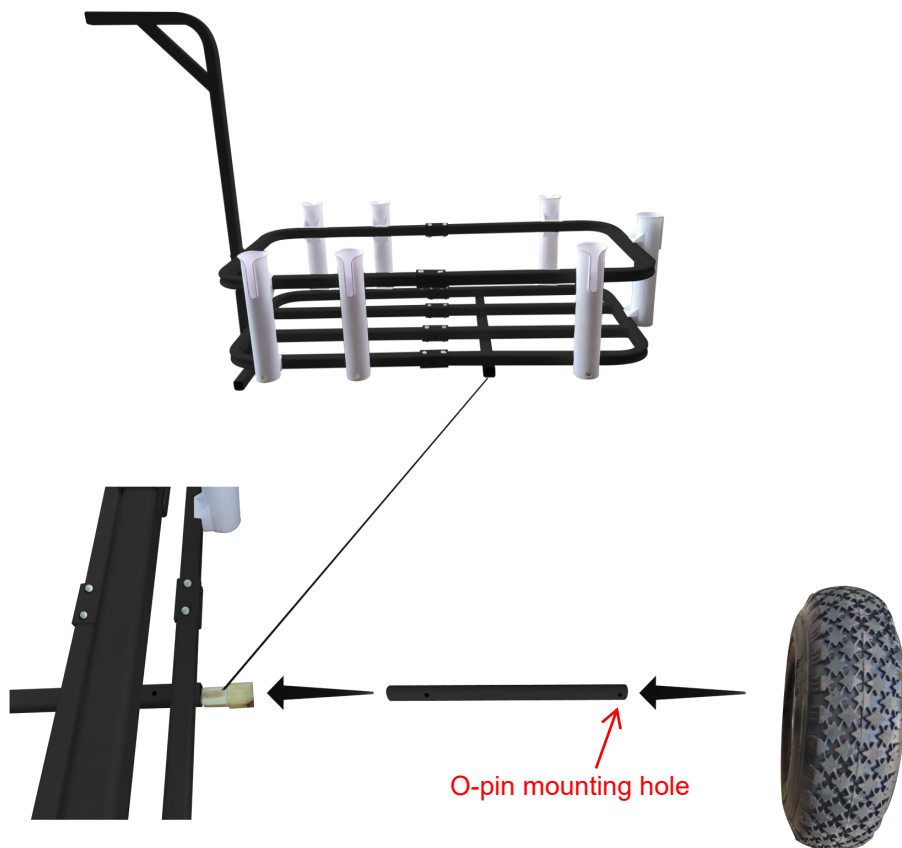

**NOTA:** Inserte las piezas de plástico del eje de la rueda en los extremos del travesaño inferior del marco, luego inserte el eje de la rueda y finalmente instale la rueda en él.

**Paso 5:** Coloque primero la lavadora y luego inserte el pasador O.





**Paso 6:** Complete la instalación e infle el neumático antes de usarlo.

## MAINTENANCE

1. Limpia la superficie después de cada uso.
2. Confirme que el carrito esté intacto y que la presión de los neumáticos sea normal antes de cada uso.
3. Verifique que los pernos estén apretados.

**Dirección:** Baoshanqu Shuangchenglu 803long 11hao 1602A-1609shi  
Shanghai

**Importado a AUS:** SIHAO PTY LTD, 1 ROKEVA STREETEASTWOOD  
NSW 2122 Australia

**Importado a EE. UU.:** Sanven Technology Ltd, Suite 250, 9166 Anaheim  
Place, Rancho Cucamonga, CA 91730

<b>EC</b>	<b>REP</b>
-----------	------------

SHUNSHUN GmbH  
Römeräcker 9 Z2021, 76351  
Linkenheim-Hochstetten, Germany

<b>UK</b>	<b>REP</b>
-----------	------------

Pooledas Group Ltd  
Unit 5 Albert Edward House, The  
Pavilions Preston, United Kingdom

**Hecho en china**



**VEVOR**<sup>®</sup>

**TOUGH TOOLS, HALF PRICE**

**Técnico Certificado de soporte y garantía electrónica**

**[www.vevor.com/support](http://www.vevor.com/support)**



# **VEVOR<sup>®</sup>**

## **TOUGH TOOLS, HALF PRICE**

Wsparcie techniczne i certyfikat e-gwarancji

[www.vevor.com/support](http://www.vevor.com/support)

## **WÓZEK WĘDKARSKI**

### **MODEL: YK-200**

We continue to be committed to provide you tools with competitive price.

"Save Half", "Half Price" or any other similar expressions used by us only represents an estimate of savings you might benefit from buying certain tools with us compared to the major top brands and does not necessarily mean to cover all categories of tools offered by us. You are kindly reminded to verify carefully when you are placing an order with us if you are actually saving half in comparison with the top major brands.



# VEVOR®

TOUGH TOOLS, HALF PRICE

## FISHING CART

MODEL: YK-200



### NEED HELP? CONTACT US!

Have product questions? Need technical support? Please feel free to contact us:

**Technical Support and E-Warranty Certificate**  
**[www.vevor.com/support](http://www.vevor.com/support)**

This is the original instruction, please read all manual instructions carefully before operating. VEVOR reserves a clear interpretation of our user manual. The appearance of the product shall be subject to the product you received. Please forgive us that we won't inform you again if there are any technology or software updates on our product.

## SAFETY INSTRUCTIONS

1. Proszę potwierdzić, że wózek jest nienaruszony i czy ciśnienie w oponach jest prawidłowe normalne przed każdym użyciem. Przed użyciem kół należy trochę napompować i uważać, aby nie napompować ich nadmiernie !
2. Zabrania się przewożenia osób w jakichkolwiek warunkach.
3. Zabrania się ładowania artykułów na terenie nierównym i pagórkowatym.
4. Przeciążanie jest surowo zabronione.
5. Nie poruszaj się zbyt szybko, mijając dziury.

## MODEL AND PARAMETERS

<b>Model</b>	YK -200
<b>Maks. Obciążenie</b>	200 funtów
<b>Koła</b>	11-calowe, nadmuchiwane, gumowe
<b>Beczka na wędkę</b>	7
<b>Rozmiar ramy</b>	34 x 14,5 x 7 cali
<b>Materiał</b>	Stal
<b>Kolor</b>	Czarny

## STRUCTURE DIAGRAM

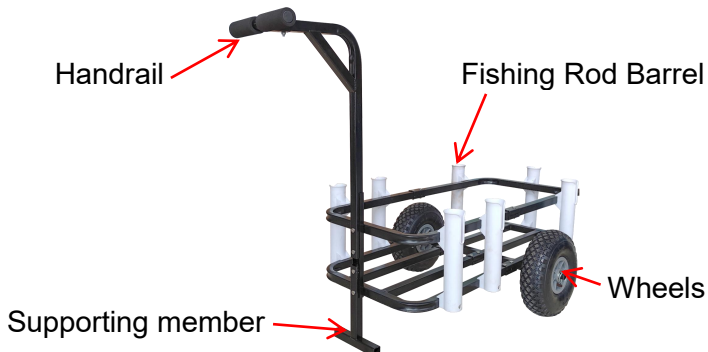

## INSTALLATION

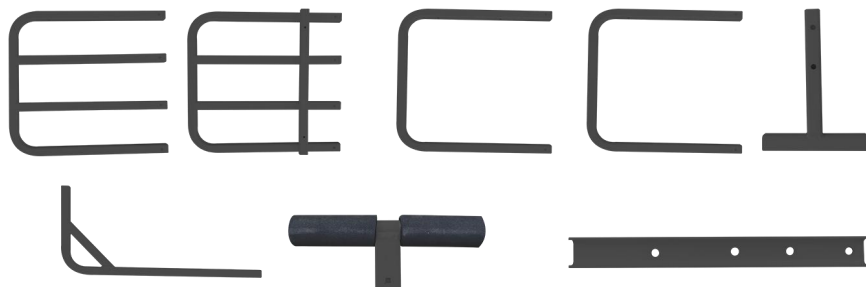

Część ramy x1 (każda za jedną)



Blokada połączenia B  
x12



koła x2



Podkładka x2



Xle x 2 \_



O- pin x2



Rozpórka osi x2



Beczka na wędkę x 7



W rench x 1



Klucz sześciokątny 3  
mm x 1



Klucz sześciokątny 4 mm x 2	Śruby M5x35 x14 (Potrzebuję trzynastu, jeszcze jednego)	Śruby M5x16 x15 (Potrzebuję czternastu, jeszcze jednego)
--------------------------------	---	--

		
Śruby M6x25 x3 (Potrzebuję dwóch, jeszcze jednego)	Śruby M6x50 x3 (Potrzebuję dwóch, jeszcze jednego)	Instrukcja obsługi x1

**Krok 1:** Połącz ze sobą dwie dolne ramy za pomocą śrub M5x35 i bloku łączącego.

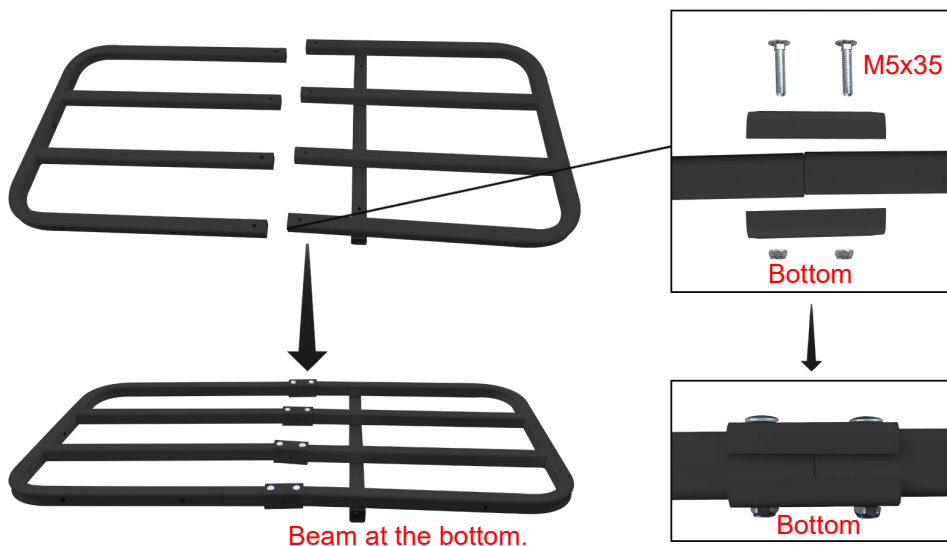

**Krok 2:** **W ten sam sposób** przymocuj górną ramę.

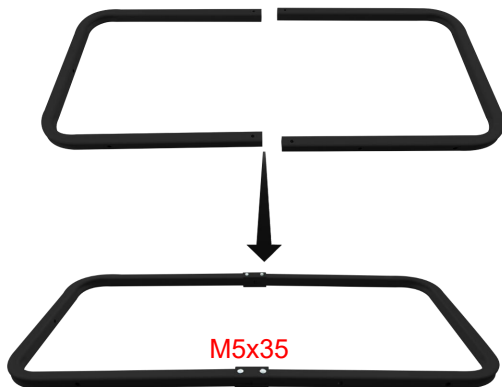

### Krok 3: Montaż ramy . \_

**UWAGA:** Ramy posiadają wstępnie nawiercone otwory do montażu beczek wędkarskich. Liczba wstępnie nawierconych otworów w ramie górnej i dolnej po tej samej stronie powinna być taka sama.



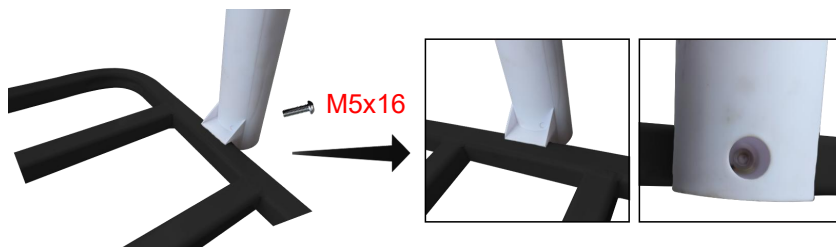
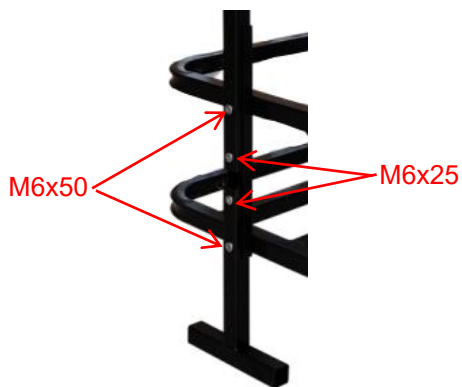

**Krok 4:** Zamontuj wszystkie beczki prętów, a następnie koła .



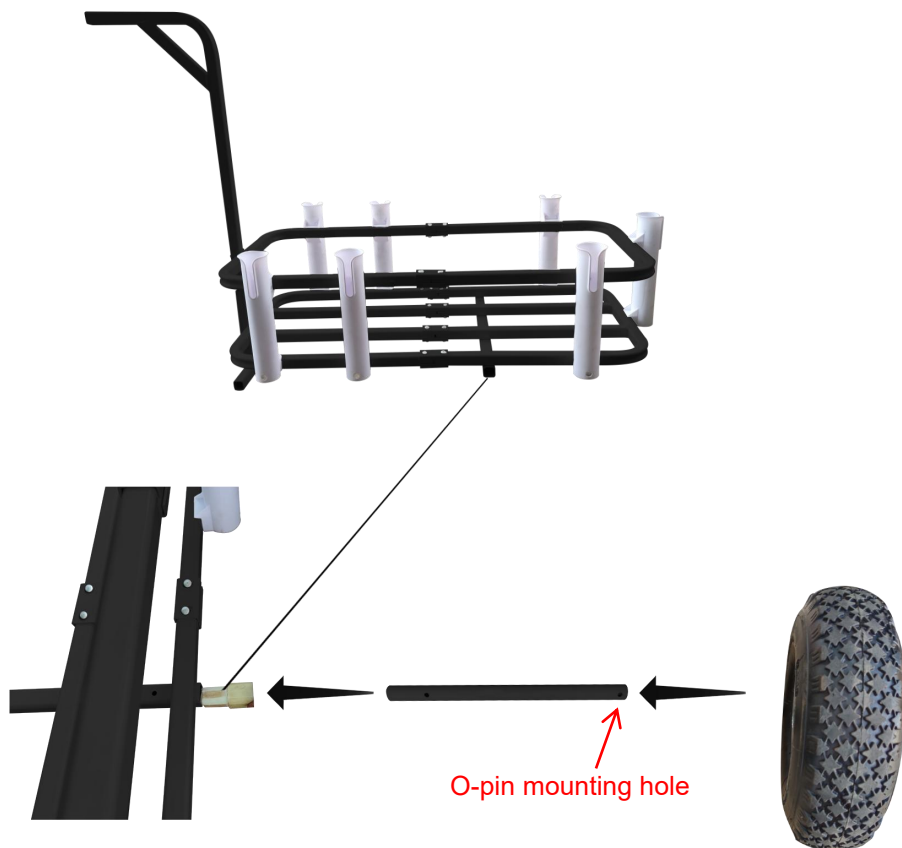

**UWAGA:** Włóż plastikowe części osi koła w końcówki dolnej poprzeczki ramy, następnie włóż oś koła i na koniec zamontuj na niej koło.

**Krok 5:** Najpierw włóż podkładkę , a następnie włóż kolek O.





**Krok 6:** Zakończ montaż i napompuj oponę przed użyciem.

## MAINTENANCE

1. Oczyszczyć powierzchnię po każdym użyciu.
2. Proszę sprawdzić, czy wózek jest nienaruszony i czy ciśnienie w oponach jest prawidłowe normalne przed każdym użyciem.
3. Sprawdź, czy śruby są dokręcone.

**Adres:** Baoshanqu Shuangchenglu 803long 11hao 1602A-1609shi  
Szanghaj

**Import do AUS:** SIHAO PTY LTD, 1 ROKEVA STREETEASTWOOD NSW  
2122 Australia

**Import do USA:** Sanven Technology Ltd, Suite 250, 9166 Anaheim Place,  
Rancho Cucamonga, CA 91730



SHUNSHUN GmbH  
Römeräcker 9 Z2021, 76351  
Linkenheim-Hochstetten, Germany



Pooledas Group Ltd  
Unit 5 Albert Edward House, The  
Pavilions Preston, United Kingdom

**Wyprodukowano w Chinach**



**VEVOR**<sup>®</sup>

**TOUGH TOOLS, HALF PRICE**

**Techniczny Certyfikat wsparcia i e-gwarancji**

**[www.vevor.com/support](http://www.vevor.com/support)**

# **VEVOR<sup>®</sup>**

## **TOUGH TOOLS, HALF PRICE**

Technische ondersteuning en e-garantiecertificaat

[www.vevor.com/support](http://www.vevor.com/support)

## **VISSERSKAR**

### **MODEL: YK-200**

We continue to be committed to provide you tools with competitive price.

"Save Half", "Half Price" or any other similar expressions used by us only represents an estimate of savings you might benefit from buying certain tools with us compared to the major top brands and does not necessarily mean to cover all categories of tools offered by us. You are kindly reminded to verify carefully when you are placing an order with us if you are actually saving half in comparison with the top major brands.



# VEVOR<sup>®</sup>

TOUGH TOOLS, HALF PRICE

## FISHING CART

MODEL: YK-200



### NEED HELP? CONTACT US!

Have product questions? Need technical support? Please feel free to contact us:

**Technical Support and E-Warranty Certificate**  
**[www.vevor.com/support](http://www.vevor.com/support)**

This is the original instruction, please read all manual instructions carefully before operating. VEVOR reserves a clear interpretation of our user manual. The appearance of the product shall be subject to the product you received. Please forgive us that we won't inform you again if there are any technology or software updates on our product.



## SAFETY INSTRUCTIONS

1. Bevestig dat de wagen intact is en dat de bandenspanning hoog is normaal vóór elk gebruik. Blaas een beetje op voordat u de wielen gebruikt, en pas op dat u de wielen niet te hard opblaast !
2. Het is onder geen enkele omstandigheid verboden mensen te vervoeren.
3. Het is verboden artikelen te laden op oneffen en heuvelachtig terrein.
4. Overbelasting is ten strengste verboden.
5. Beweeg niet te snel bij het passeren van kuilen.

## MODEL AND PARAMETERS

<b>Model</b>	YK -200
<b>Max. Laden</b>	200 pond
<b>Wielen</b>	11 inch, opblaasbare, rubberen
<b>Hengel vat</b>	7
<b>Framemaat</b>	34 x 14,5 x 7 inch
<b>Materiaal</b>	Staal
<b>Kleur</b>	Zwart

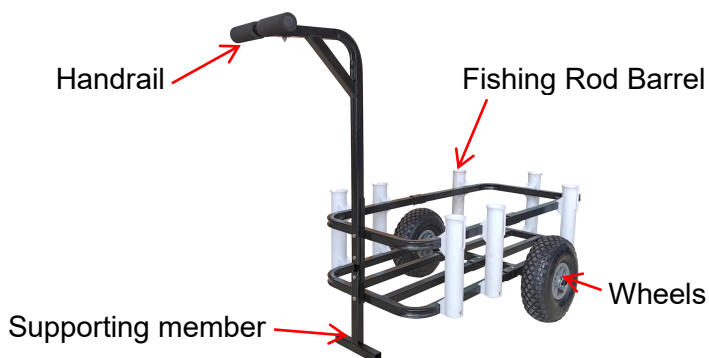

## STRUCTURE DIAGRAM



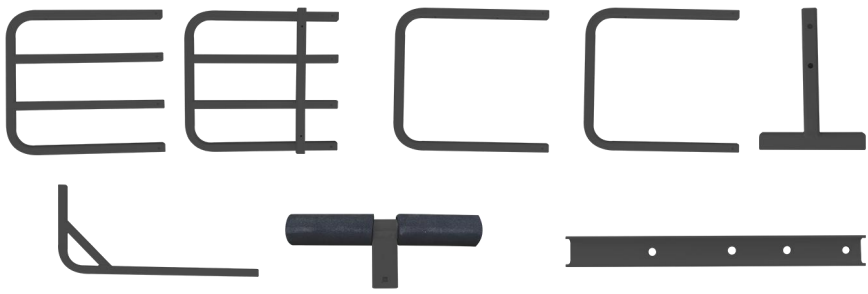

## INSTALLATION

<p>Framedeel x1 (elk voor één)</p>

		
<p>Verbindingsblokslot x12 _</p>	<p>wielen x2</p>	<p>Wasmachine x2</p>

		
<p>Een xl x 2</p>	<p>O- pin x2</p>	<p>As afstandhouder x2</p>

		
<p>Hengelton x 7</p>	<p>W rench x 1</p>	<p>3 mm inbussleutel x 1</p>

		
<p>4 mm inbussleutel x 2</p>	<p>M5x35 Bouten x14 (Dertien nodig, nog één)</p>	<p>M5x16 Bouten x15 (Veertien nodig, nog één)</p>

		
M6x25 Bouten x3 (Ik heb er twee nodig, nog één)	M6x50 Bouten x3 (Ik heb er twee nodig, nog één)	Gebruikershandleiding x1

**Stap 1:** Verbind de twee onderste frames met elkaar met behulp van de M5x35 bouten en het verbindingsblok.

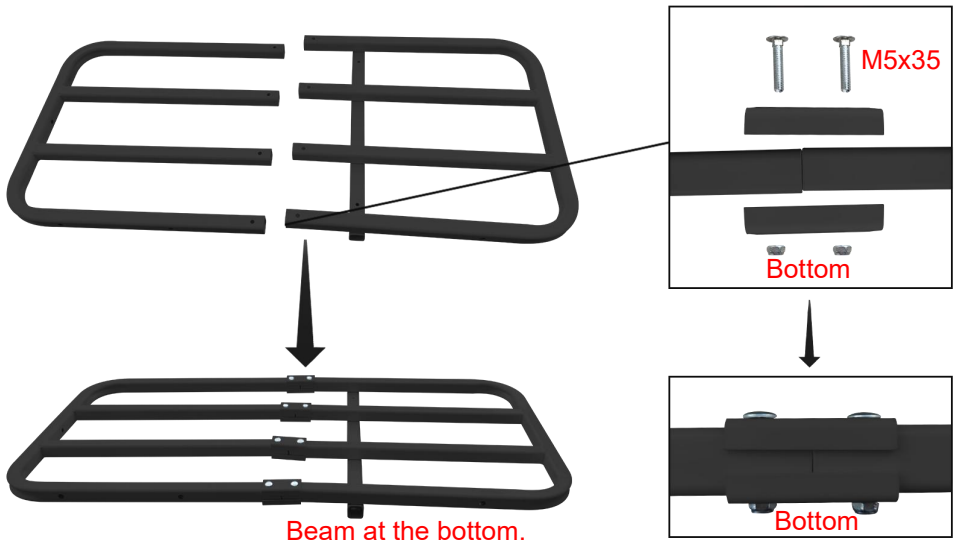

**Stap 2:** Bevestig het bovenframe op dezelfde manier.

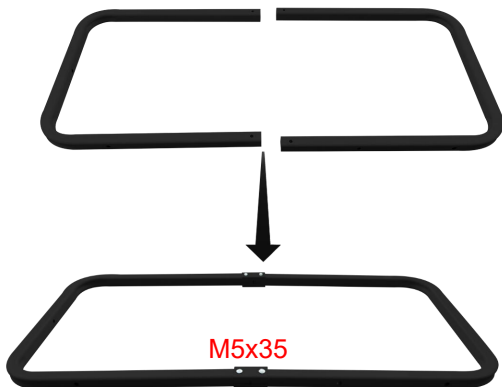

**Stap 3:** Monteren van het kozijn .

**OPMERKING:** De frames zijn voorzien van voorgeboorde gaten voor het monteren van de vistonnen. Het aantal voorgeboorde gaten op het bovenste en onderste frame aan dezelfde kant moet hetzelfde zijn.

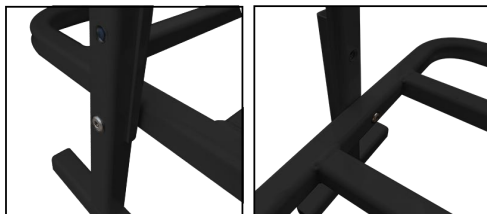

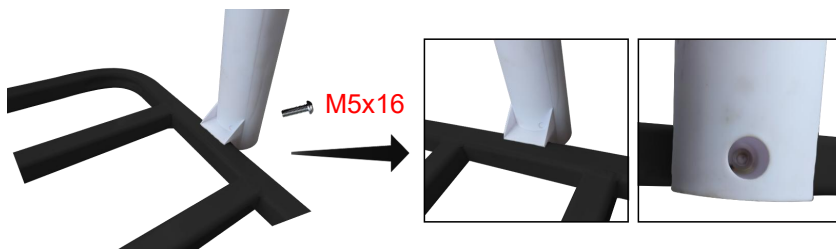
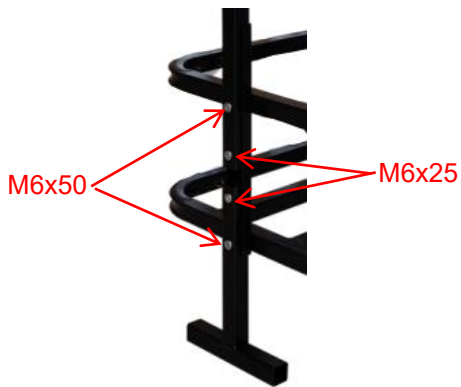

**Stap 4:** Installeer alle stanglopen en vervolgens de wielen .

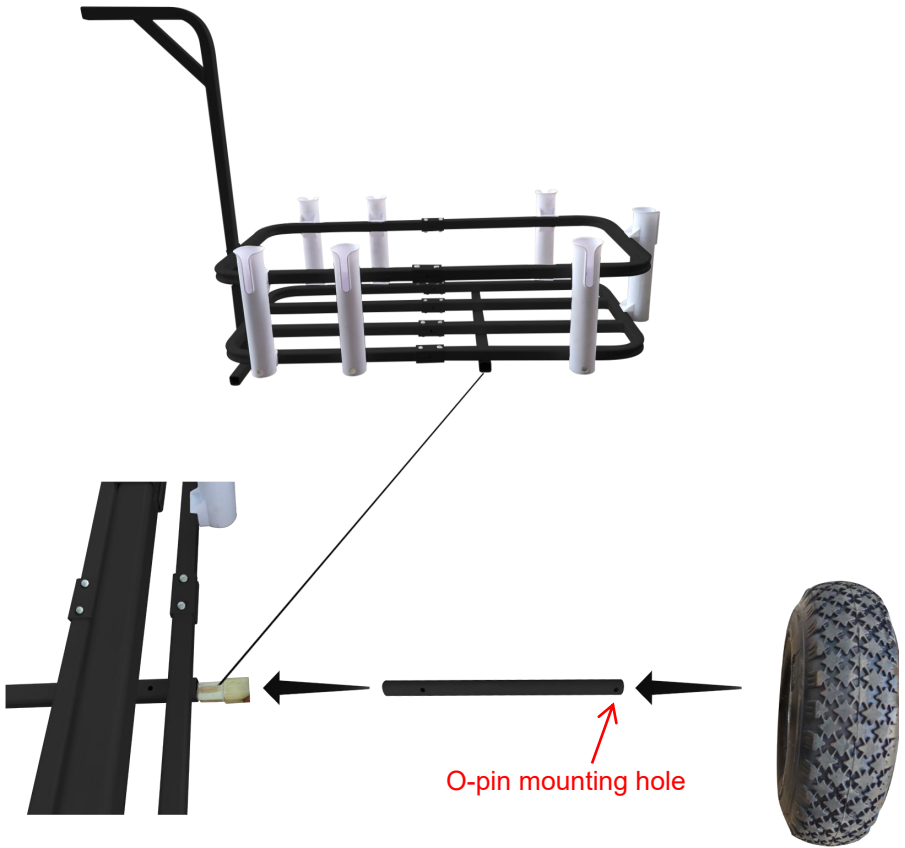

**OPMERKING:** Steek de plastic delen van de wielas in de uiteinden van de onderste dwarsbalk van het frame, steek vervolgens de wielas erin en monteer tenslotte het wiel erop.

**Stap 5:** Plaats eerst de sluitring en plaats vervolgens de O-pin.





**Stap 6:** Installatie voltooid en pomp de band op voor gebruik.

## MAINTENANCE

1. Reinig het oppervlak na elk gebruik.
2. Bevestig dat de wagen intact is en dat de bandenspanning hoog is normaal vóór elk gebruik.
3. Controleer of de bouten goed vastzitten.

**Adres:** Baoshanqu Shuangchenglu 803long 11hao 1602A-1609shi  
Shanghai

**Geïmporteerd naar AUS:** SIHAO PTY LTD, 1 ROKEVA  
STREETEASTWOOD NSW 2122 Australië

**Geïmporteerd naar de VS:** Sanven Technology Ltd, Suite 250, 9166  
Anaheim Place, Rancho Cucamonga, CA 91730



SHUNSHUN GmbH  
Römeräcker 9 Z2021, 76351  
Linkenheim-Hochstetten, Germany



Pooledas Group Ltd  
Unit 5 Albert Edward House, The  
Pavilions Preston, United Kingdom

**Gemaakt in China**





**VEVOR**<sup>®</sup>

**TOUGH TOOLS, HALF PRICE**

**Technisch Ondersteuning en e-garantiecertificaat**

**[www.vevor.com/support](http://www.vevor.com/support)**

# **VEVOR<sup>®</sup>**

## **TOUGH TOOLS, HALF PRICE**

Teknisk support och e-garanticertifikat

[www.vevor.com/support](http://www.vevor.com/support)

### **FISKEVAGN**

### **MODELL: YK-200**

We continue to be committed to provide you tools with competitive price.

"Save Half", "Half Price" or any other similar expressions used by us only represents an estimate of savings you might benefit from buying certain tools with us compared to the major top brands and does not necessarily mean to cover all categories of tools offered by us. You are kindly reminded to verify carefully when you are placing an order with us if you are actually saving half in comparison with the top major brands.



# VEVOR®

TOUGH TOOLS, HALF PRICE

## FISHING CART

MODELL: YK-200



### NEED HELP? CONTACT US!

Have product questions? Need technical support? Please feel free to contact us:

**Technical Support and E-Warranty Certificate**  
**[www.vevor.com/support](http://www.vevor.com/support)**

This is the original instruction, please read all manual instructions carefully before operating. VEVOR reserves a clear interpretation of our user manual. The appearance of the product shall be subject to the product you received. Please forgive us that we won't inform you again if there are any technology or software updates on our product.

## SAFETY INSTRUCTIONS

1. Kontrollera att vagnen är hel och att däcktrycket är normalt före varje användning. Blås upp lite innan du använder hjulen och var försiktig så att du inte blåser upp för mycket !
2. Det är förbjudet att transportera människor under alla förhållanden.
3. Det är förbjudet att lasta föremål i ojämn och kuperad terräng.
4. Överbelastning är strängt förbjuden.
5. Rör dig inte för snabbt när du passerar gropar.

## MODEL AND PARAMETERS

<b>Modell</b>	YK- 200
<b>Max. Ladda</b>	200 lbs
<b>Hjul</b>	11 tum, uppblåsbara, gummihjul*2
<b>Fiskspö fat</b>	7
<b>Ramstorlek (inuti )</b>	34 x 14,5 x 7 tum
<b>Material</b>	Stål
<b>Färg</b>	Svart

## STRUCTURE DIAGRAM

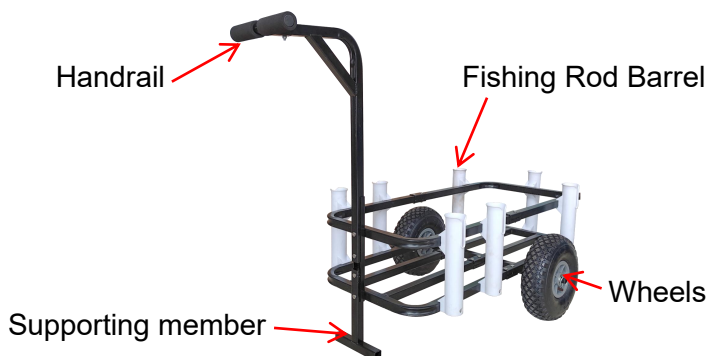

## INSTALLATION

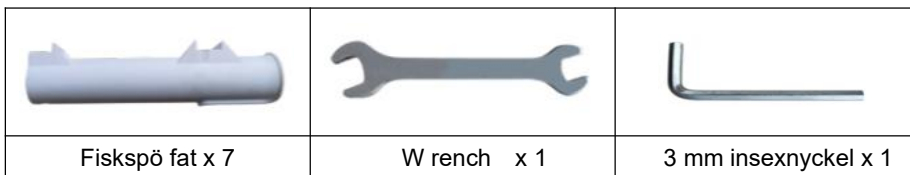
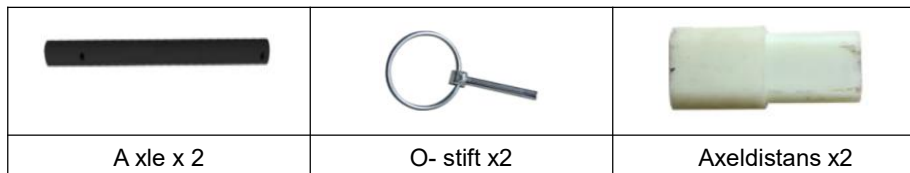
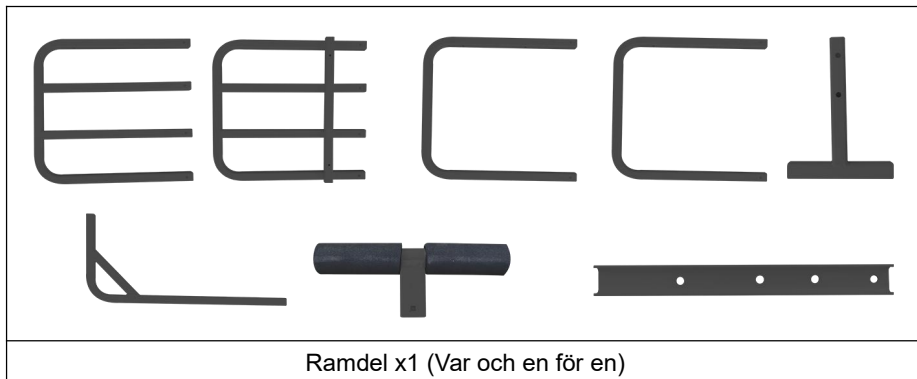

		
M6x25 Bultar x3 (Behöver två, en till)	M6x50 Bultar x3 (Behöver två, en till)	Användarmanual x1

**Steg 1:** Koppla ihop de två nedre ramarna med M5x35-bultarna och anslutningsblocket.

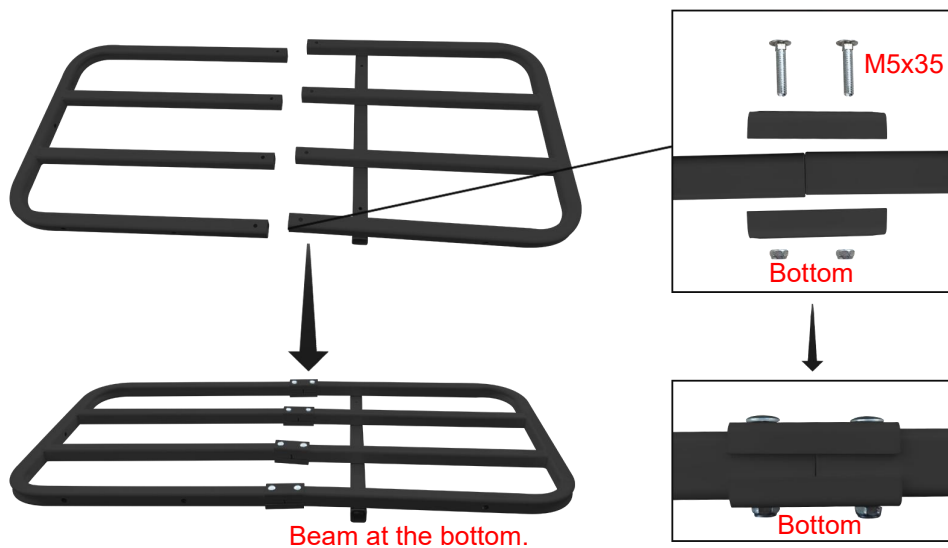

**Steg 2:** Fäst den övre ramen på samma sätt.

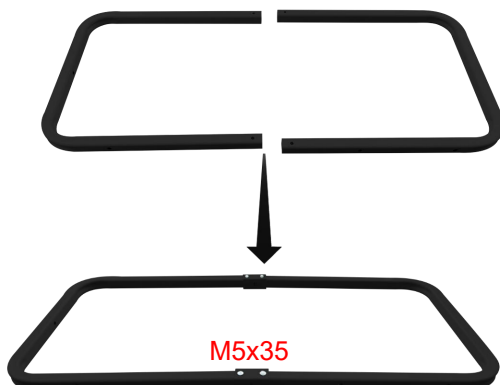



### Steg 3: Montering av ramen .

**OBS:** Ramarna har förborrade hål för montering av fisketunnorna. Antalet förborrade hål på den övre och nedre ramen på samma sida ska vara detsamma.

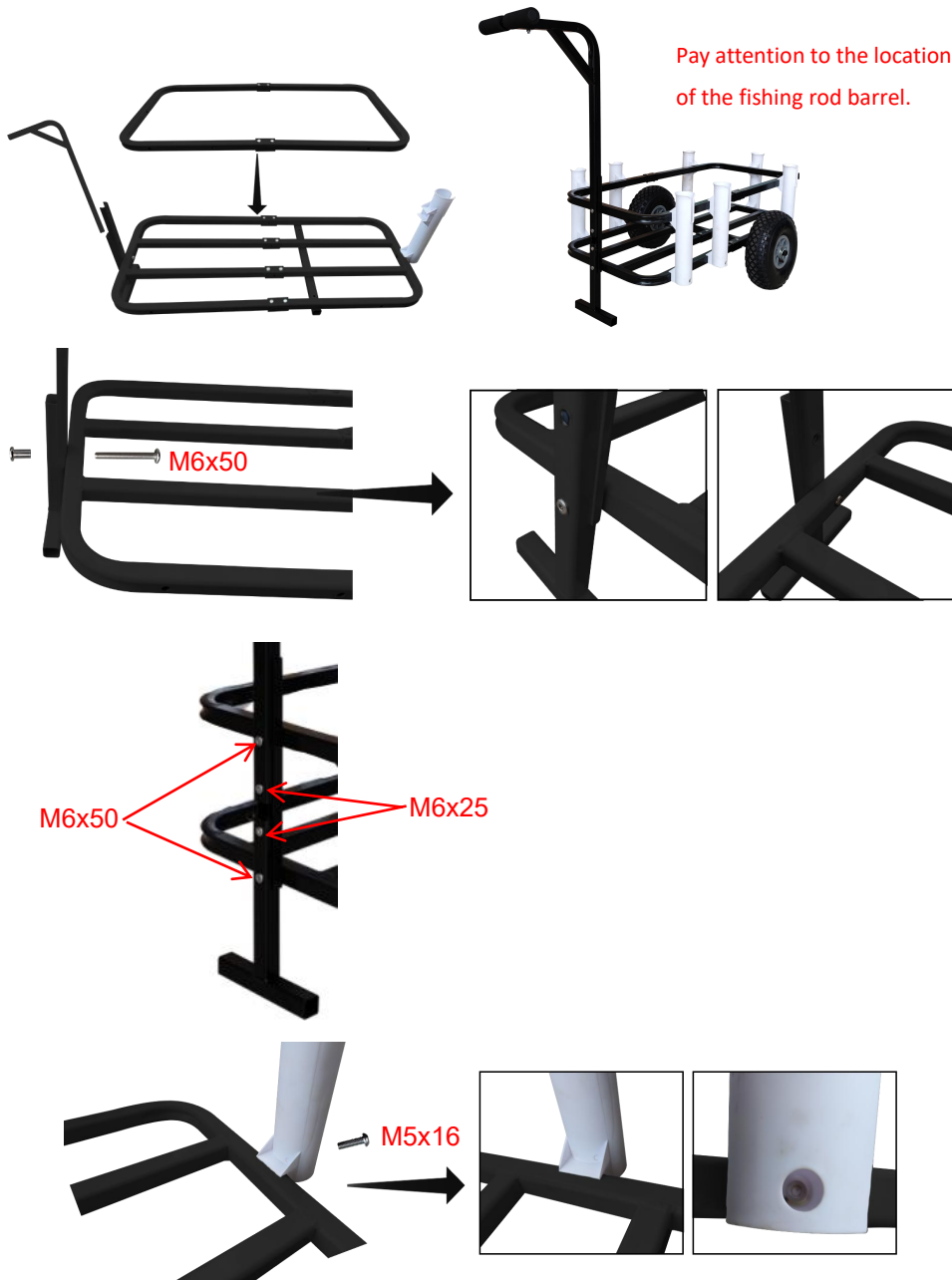

**Steg 4:** Installera alla stångpipor, sedan hjul .

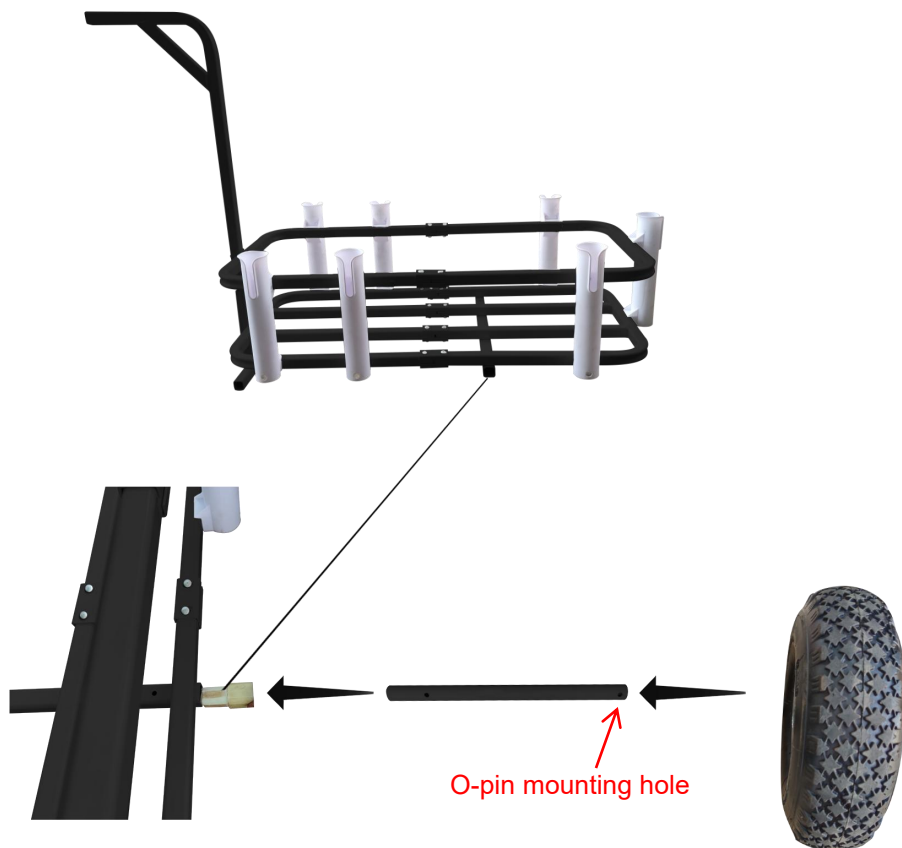

**OBS:** Sätt in plastdelarna på hjulaxeln i ändarna av den nedre tvärbalken på ramen, sätt sedan in hjulaxeln och installera slutligen hjulet på den.

**Steg 5:** Sätt först i brickan och sätt sedan i O- stiftet.





**Steg 6:** Installationen slutförs och pumpa upp däcket före användning.

## MAINTENANCE

1. Rengör ytan efter varje användning.
2. Kontrollera att vagnen är hel och att däcktrycket är normalt före varje användning.
3. Kontrollera att bultarna är åtdragna.

**Adress:** Baoshanqu Shuangchenglu 803long 11hao 1602A-1609shi  
Shanghai

**Importerad till AUS:** SIHAO PTY LTD, 1 ROKEVA STREETEASTWOOD  
NSW 2122 Australien

**Importerad till USA:** Sanven Technology Ltd, Suite 250, 9166 Anaheim  
Place, Rancho Cucamonga, CA 91730



SHUNSHUN GmbH  
Römeräcker 9 Z2021, 76351  
Linkenheim-Hochstetten, Germany



Pooledas Group Ltd  
Unit 5 Albert Edward House, The  
Pavilions Preston, United Kingdom

**Tillverkad i Kina**



**VEVOR**<sup>®</sup>

**TOUGH TOOLS, HALF PRICE**

**Teknisk Support och e-garanticertifikat**

**[www.vevor.com/support](http://www.vevor.com/support)**