

VEVOR[®]

TOUGH TOOLS, HALF PRICE

Technical Support and E-Warranty Certificate www.vevor.com/support

POOL GATE

MODEL:NLGTR01

We continue to be committed to provide you tools with competitive price.

"Save Half", "Half Price" or any other similar expressions used by us only represents an estimate of savings you might benefit from buying certain tools with us compared to the major top brands and does not necessarily mean to cover all categories of tools offered by us. You are kindly reminded to verify carefully when you are placing an order with us if you are actually saving half in comparison with the top major brands.

VEVOR[®]

TOUGH TOOLS, HALF PRICE

Pool GATE

Model:NLGTR01



NEED HELP? CONTACT US!

Have product questions? Need technical support? Please feel free to contact us:
Technical Support and E-Warranty Certificate www.vevor.com/support

This is the original instruction, please read all manual instructions carefully before operating. VEVOR reserves a clear interpretation of our user manual. The appearance of the product shall be subject to the product you received. Please forgive us that we won't inform you again if there are any technology or software updates on our product.

BEFORE YOU START:

Please read the instructions in their entirety prior to installation to ensure a smooth and proper installation. Retain the manual for future reference.

SPECIFICATIONS

Model	NLGTR01
Product Size	4*2.5ft
Color	Black

Required tools

1.Utility knife
2.Rotary hammer drill
3.5/8" SDS masonry drill bit
4.1/4" Phillips Head screwdriver
5.Extension cord
6.Measuring tape
7.Pencil or white chalk
8.Hammer or rubber mallet
9.Square and level

PARTS LIST

			
<p>Left gate post ×1</p>	<p>Gate ×1</p>	<p>Right gate post ×1</p>	
			
<p>① Pin ×4</p>	<p>② Peg ×4</p>	<p>③ Peg cover ×4</p>	<p>④ Gate hook</p>
			
<p>Template for hole placement ×1</p>			

Installation

Step 1: Install the pin

Step 2: Install the Gate hook

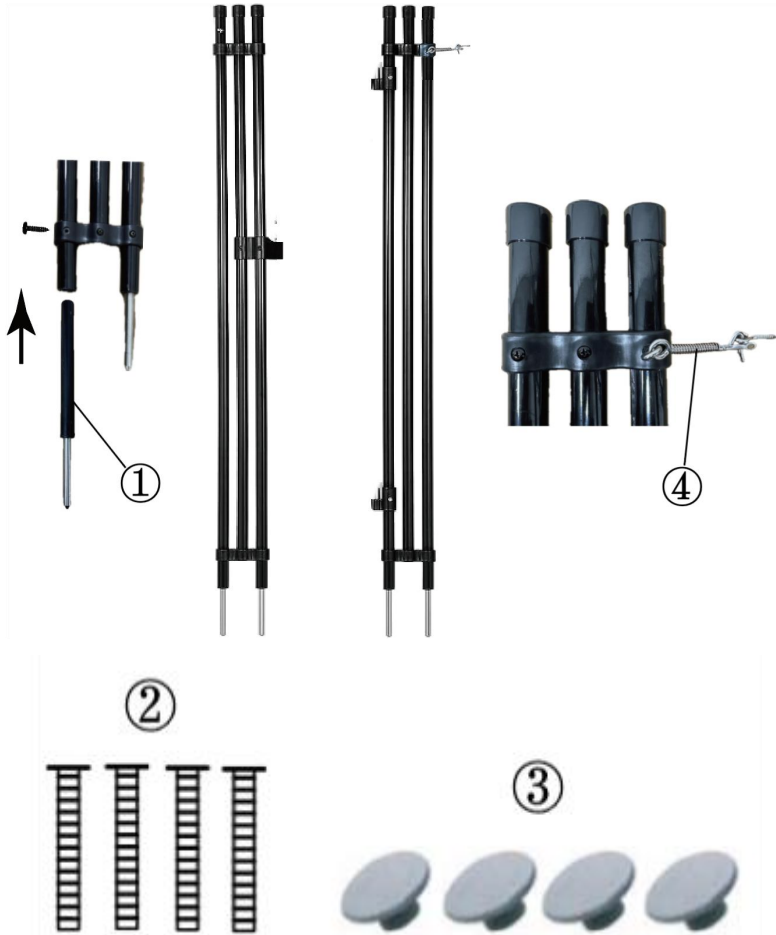

Step 3: Mark the position of the mounting holes with the template for hole placement.

NOTE: The two holes on the left and right sides are used to install the fence adjacent to the door.

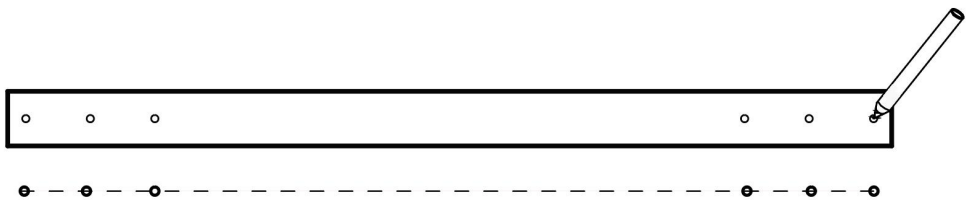

Step 4:Drilling

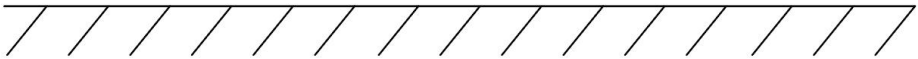
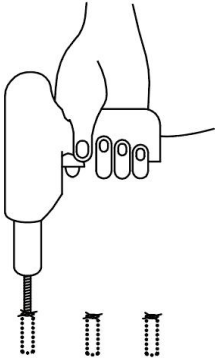

Step 5:Install the peg

Sleeving: Once drilling is completed, flush out the debris from the holes using a garden hose. Next insert the plastic sleeves in the holes and tap down completely .

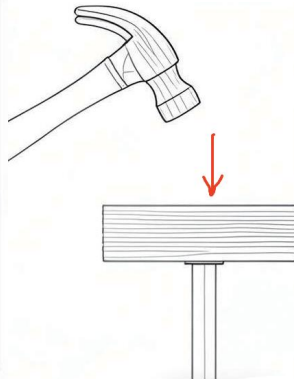
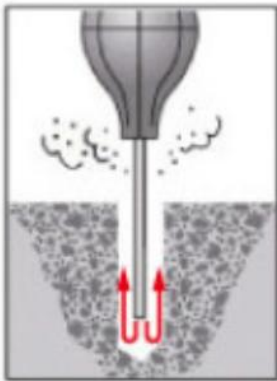

Tip:To avoid damaging the sleeve, place a piece of wood on top of the sleeve as illustrated,and gently hammer the sleeve down into the hole until it sinks into the ground.

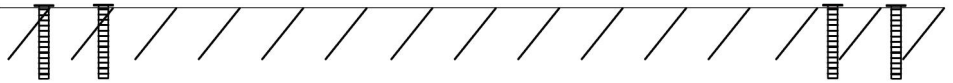

Step 6:Insert the left and right gate post into the pegs then ,install the gate to complete the installation.

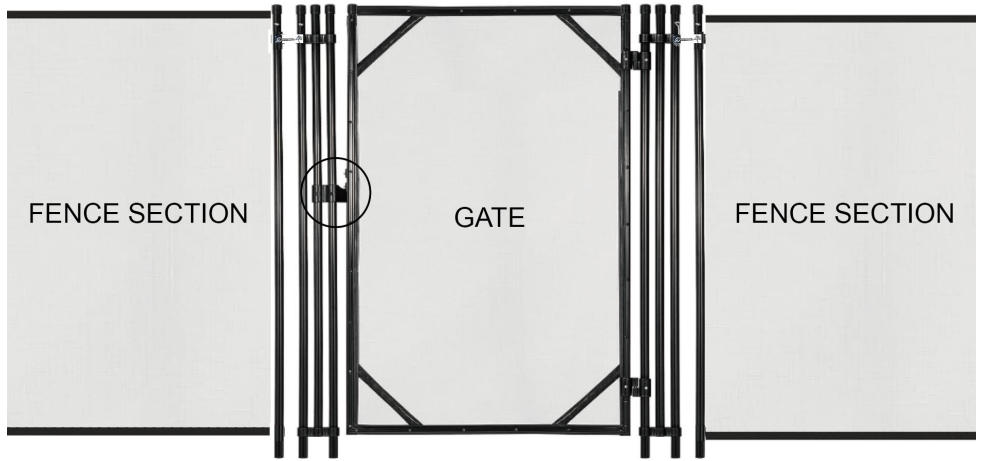

Turn and pull the lock to open the door lock, operate in the opposite direction to lock the door.

Note: This product does not include the fence part, which needs to be purchased and installed separately.

WARNING: THE POLE CANNOT BE REMOVED IF YOU SIMPLY PULL WITHOUT TURNING IT AT THE SAME TIME. IT IS IMPERATIVE THAT ACCESS POINTS ARE CLOSED AT THE END OF THE SEASON OF SUPERVISED SWIMMING.

1. Maintenance

Try to regularly monitor all safety fence components. If any of the components should be damaged, especially those relating to closing, please contact the shop where you purchased the barrier immediately in order to obtain a replacement part. It is imperative to replace the elements or groups of elements that are damaged as soon as possible. Do not use parts that are not officially approved by the PROVIDER/ INSTALLER.

SAFETY PRECAUTIONS

- THE SWIMMING POOL CAN BE A HAZARD TO YOUR CHILDREN. DROWNING MAY HAPPEN VERY QUICKLY. WHEN CHILDREN ARE NEAR THE POOL THEY REQUIRE CONSTANT AND ACTIVE SUPERVISION, EVEN IF THEY ARE ABLE TO SWIM.

- THIS BARRIER DOES NOT REPLACE COMMON SENSE OR INDIVIDUAL RESPONSIBILITY. THE BARRIER CANNOT REPLACE SUPERVISION CARRIED OUT BY RESPONSIBLE ADULTS WHICH STILL REMAINS THE KEY FACTOR IN PROTECTING SMALL CHILDREN.
- POINTS OF ACCESS MUST BE CLOSED SYSTEMATICALLY WHEN NO ONE IS HOME, EVEN IF IT IS FOR A SHORT PERIOD OF TIME.
- WARNING! SAFETY IS GUARANTEED ONLY WHEN POINTS OF ACCESS ARE LOCKED.
- CHECK WHETHER THERE ARE ELEMENTS NEAR THE BARRIER THAT COULD ENABLE OR FACILITATE CLIMBING THE FENCE.
- CLOSING POINTS OF ACCESS THROUGH AUTOMATED CLOSING SYSTEMS SHOULD BE CHECKED SYSTEMATICALLY.
- WHEN THE BARRIER IS BROKEN OR DAMAGED AND REQUIRES REPAIR WORK, IT IS VERY IMPORTANT TO INCREASE SUPERVISION TO PREVENT SMALL CHILDREN FROM ACCESSING THE POOL.



- LEARN RESCUE TECHNIQUES (CARDIOPULMONARY RESUSCITATION) AND UPDATE YOUR KNOWLEDGE PERIODICALLY. IT COULD SAVE A LIFE IN AN EMERGENCY.
- THE PRESENCE OF PARENTS AND/OR OTHER RESPONSIBLE ADULTS IS REQUIRED WHEN THE POOL IS ACCESSIBLE.

MEMORIZE AND DISPLAY NEAR THE POOL THE FIRST AID NUMBERS.

FIREFIGHTERS

EMERGENCY MEDICAL SERVICES

POISON CONTROL CENTER

Manufacturer: Shanghaimuxinmuyeyouxiangongsi

Address: Shuangchenglu 803nong11hao1602A-1609shi, baoshanqu, shanghai 200000 CN.

Imported to AUS: SIHAO PTY LTD. 1 ROKEVA STREETEASTWOOD NSW 2122 Australia

Imported to USA: Sanven Technology Ltd. Suite 250, 9166 Anaheim Place, Rancho Cucamonga, CA 91730

UK	REP
-----------	------------

YH CONSULTING LIMITED. C/O YH Consulting Limited Office 147, Centurion House, London Road, Staines-upon-Thames, Surrey, TW18 4AX

EC	REP
-----------	------------

E-CrossStu GmbH
Mainzer Landstr.69,
60329 Frankfurt am Main.

VEVOR[®]

TOUGH TOOLS, HALF PRICE

Technical Support and E-Warranty Certificate

www.vevor.com/support

VEVOR®

TOUGH TOOLS, HALF PRICE

Technical Support and E-Warranty Certificate www.vevor.com/support

POOL GATE

MODEL:NLGTR01

We continue to be committed to provide you tools with competitive price.

"Save Half", "Half Price" or any other similar expressions used by us only represents an estimate of savings you might benefit from buying certain tools with us compared to the major top brands and does not necessarily mean to cover all categories of tools offered by us. You are kindly reminded to verify carefully when you are placing an order with us if you are actually saving half in comparison with the top major brands.

VEVOR[®]

TOUGH TOOLS, HALF PRICE

Pool GATE

Model:NLGTR01



NEED HELP? CONTACT US!

Have product questions? Need technical support? Please feel free to contact us:
Technical Support and E-Warranty Certificate www.vevor.com/support

This is the original instruction, please read all manual instructions carefully before operating. VEVOR reserves a clear interpretation of our user manual. The appearance of the product shall be subject to the product you received. Please forgive us that we won't inform you again if there are any technology or software updates on our product.

BEFORE YOU START:

Please read the instructions in their entirety prior to installation to ensure a smooth and proper installation. Retain the manual for future reference.

SPECIFICATIONS

Model	NLGTR01
Product Size	4*2.5ft
Color	Black

Required tools

1.Utility knife
2.Rotary hammer drill
3.5/8" SDS masonry drill bit
4.1/4" Phillips Head screwdriver
5.Extension cord
6.Measuring tape
7.Pencil or white chalk
8.Hammer or rubber mallet
9.Square and level

PARTS LIST

			
<p>Left gate post ×1</p>	<p>Gate ×1</p>	<p>Right gate post ×1</p>	
			
<p>① Pin ×4</p>	<p>② Peg ×4</p>	<p>③ Peg cover ×4</p>	<p>④ Gate hook</p>
			
<p>Template for hole placement ×1</p>			

Installation

Step 1: Install the pin

Step 2: Install the Gate hook

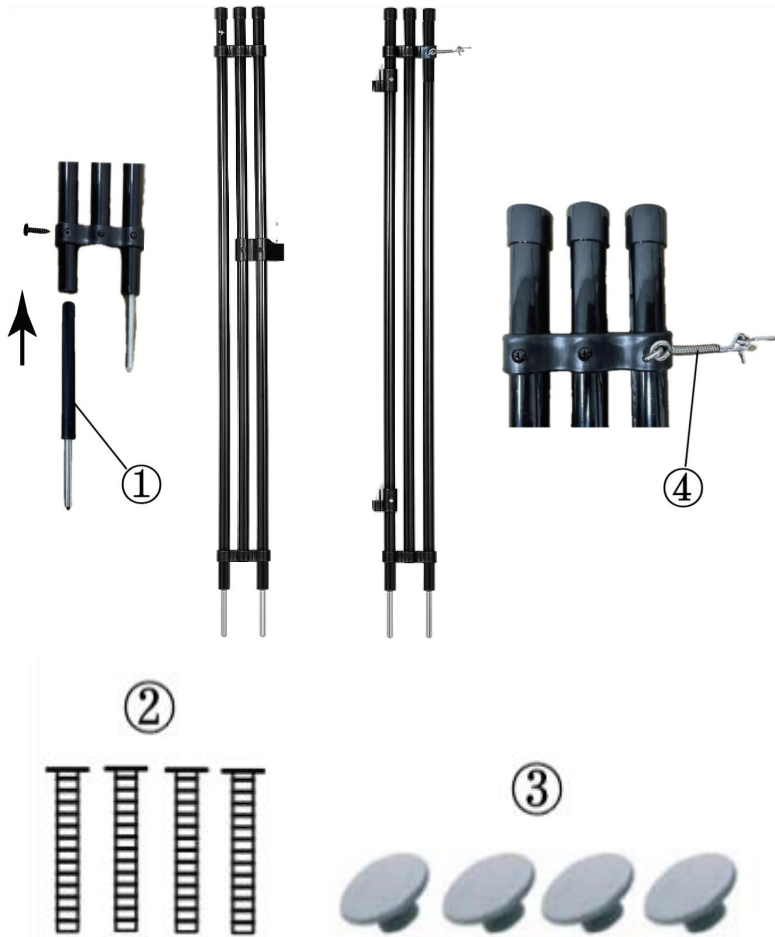

Step 3: Mark the position of the mounting holes with the template for hole placement.

NOTE: The two holes on the left and right sides are used to install the fence adjacent to the door.

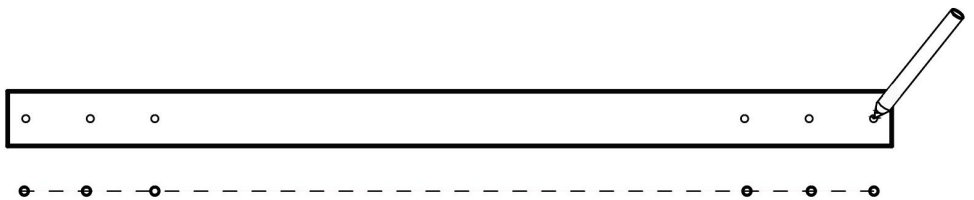

Step 4:Drilling

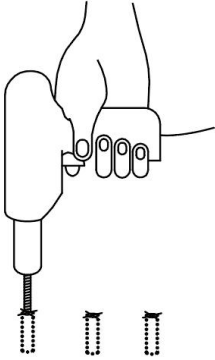

Step 5:Install the peg

Sleeving: Once drilling is completed, flush out the debris from the holes using a garden hose. Next insert the plastic sleeves in the holes and tap down completely .

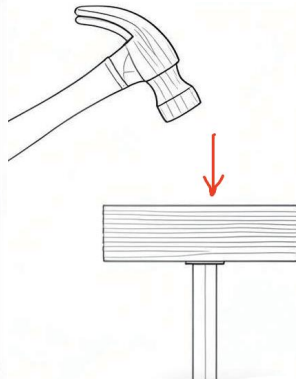
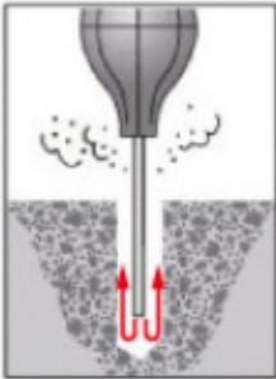

Tip:To avoid damaging the sleeve, place a piece of wood on top of the sleeve as illustrated,and gently hammer the sleeve down into the hole until it sinks into the ground.

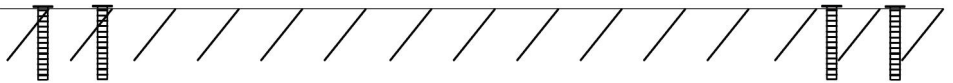

Step 6:Insert the left and right gate post into the pegs then ,install the gate to complete the installation.

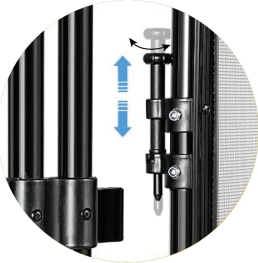
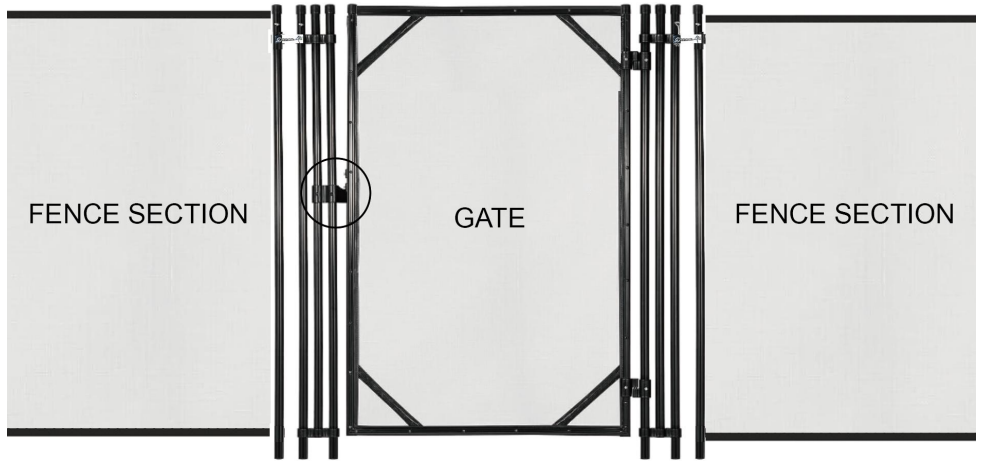

Turn and pull the lock to open the door lock, operate in the opposite direction to lock the door.

Note: This product does not include the fence part, which needs to be purchased and installed separately.

WARNING: THE POLE CANNOT BE REMOVED IF YOU SIMPLY PULL WITHOUT TURNING IT AT THE SAME TIME. IT IS IMPERATIVE THAT ACCESS POINTS ARE CLOSED AT THE END OF THE SEASON OF SUPERVISED SWIMMING.

2. Maintenance

Try to regularly monitor all safety fence components. If any of the components should be damaged, especially those relating to closing, please contact the shop where you purchased the barrier immediately in order to obtain a replacement part. It is imperative to replace the elements or groups of elements that are damaged as soon as possible. Do not use parts that are not officially approved by the PROVIDER/ INSTALLER.

SAFETY PRECAUTIONS

- THE SWIMMING POOL CAN BE A HAZARD TO YOUR CHILDREN. DROWNING MAY HAPPEN VERY QUICKLY. WHEN CHILDREN ARE NEAR THE POOL THEY REQUIRE CONSTANT AND ACTIVE SUPERVISION, EVEN IF THEY ARE ABLE TO SWIM.

- THIS BARRIER DOES NOT REPLACE COMMON SENSE OR INDIVIDUAL RESPONSIBILITY. THE BARRIER CANNOT REPLACE SUPERVISION CARRIED OUT BY RESPONSIBLE ADULTS WHICH STILL REMAINS THE KEY FACTOR IN PROTECTING SMALL CHILDREN.
- POINTS OF ACCESS MUST BE CLOSED SYSTEMATICALLY WHEN NO ONE IS HOME, EVEN IF IT IS FOR A SHORT PERIOD OF TIME.
- WARNING! SAFETY IS GUARANTEED ONLY WHEN POINTS OF ACCESS ARE LOCKED.
- CHECK WHETHER THERE ARE ELEMENTS NEAR THE BARRIER THAT COULD ENABLE OR FACILITATE CLIMBING THE FENCE.
- CLOSING POINTS OF ACCESS THROUGH AUTOMATED CLOSING SYSTEMS SHOULD BE CHECKED SYSTEMATICALLY.
- WHEN THE BARRIER IS BROKEN OR DAMAGED AND REQUIRES REPAIR WORK, IT IS VERY IMPORTANT TO INCREASE SUPERVISION TO PREVENT SMALL CHILDREN FROM ACCESSING THE POOL.



- LEARN RESCUE TECHNIQUES (CARDIOPULMONARY RESUSCITATION) AND UPDATE YOUR KNOWLEDGE PERIODICALLY. IT COULD SAVE A LIFE IN AN EMERGENCY.
- THE PRESENCE OF PARENTS AND/OR OTHER RESPONSIBLE ADULTS IS REQUIRED WHEN THE POOL IS ACCESSIBLE.

MEMORIZE AND DISPLAY NEAR THE POOL THE FIRST AID NUMBERS.

FIREFIGHTERS

EMERGENCY MEDICAL SERVICES

POISON CONTROL CENTER

Manufacturer: Shanghaimuxinmuyeyouxiangongsi

Address: Shuangchenglu 803nong11hao1602A-1609shi, baoshanqu, shanghai 200000 CN.

Imported to AUS: SIHAO PTY LTD. 1 ROKEVA STREETEASTWOOD NSW 2122 Australia

Imported to USA: Sanven Technology Ltd. Suite 250, 9166 Anaheim Place, Rancho Cucamonga, CA 91730

UK	REP
-----------	------------

YH CONSULTING LIMITED. C/O YH Consulting Limited Office 147, Centurion House, London Road, Staines-upon-Thames, Surrey, TW18 4AX

EC	REP
-----------	------------

E-CrossStu GmbH
Mainzer Landstr.69,
60329 Frankfurt am Main.

VEVOR[®]

TOUGH TOOLS, HALF PRICE

Technical Support and E-Warranty Certificate

www.vevor.com/support

VEVOR[®]

TOUGH TOOLS, HALF PRICE

Technical Support and E-Warranty Certificate www.vevor.com/support

POOL GATE

MODEL:NLGTR01

We continue to be committed to provide you tools with competitive price.

"Save Half", "Half Price" or any other similar expressions used by us only represents an estimate of savings you might benefit from buying certain tools with us compared to the major top brands and does not necessarily mean to cover all categories of tools offered by us. You are kindly reminded to verify carefully when you are placing an order with us if you are actually saving half in comparison with the top major brands.

VEVOR®

TOUGH TOOLS, HALF PRICE

Pool GATE

Model:NLGTR01



NEED HELP? CONTACT US!

Have product questions? Need technical support? Please feel free to contact us:
Technical Support and E-Warranty Certificate www.vevor.com/support

This is the original instruction, please read all manual instructions carefully before operating. VEVOR reserves a clear interpretation of our user manual. The appearance of the product shall be subject to the product you received. Please forgive us that we won't inform you again if there are any technology or software updates on our product.

BEFORE YOU START:

Please read the instructions in their entirety prior to installation to ensure a smooth and proper installation. Retain the manual for future reference.

SPECIFICATIONS

Model	NLGTR01
Product Size	4*2.5ft
Color	Black

Required tools

1.Utility knife
2.Rotary hammer drill
3.5/8" SDS masonry drill bit
4.1/4" Phillips Head screwdriver
5.Extension cord
6.Measuring tape
7.Pencil or white chalk
8.Hammer or rubber mallet
9.Square and level

PARTS LIST

			
<p>Left gate post ×1</p>	<p>Gate ×1</p>	<p>Right gate post ×1</p>	
			
<p>① Pin ×4</p>	<p>② Peg ×4</p>	<p>③ Peg cover ×4</p>	<p>④ Gate hook</p>
			
<p>Template for hole placement ×1</p>			

Installation

Step 1: Install the pin

Step 2: Install the Gate hook

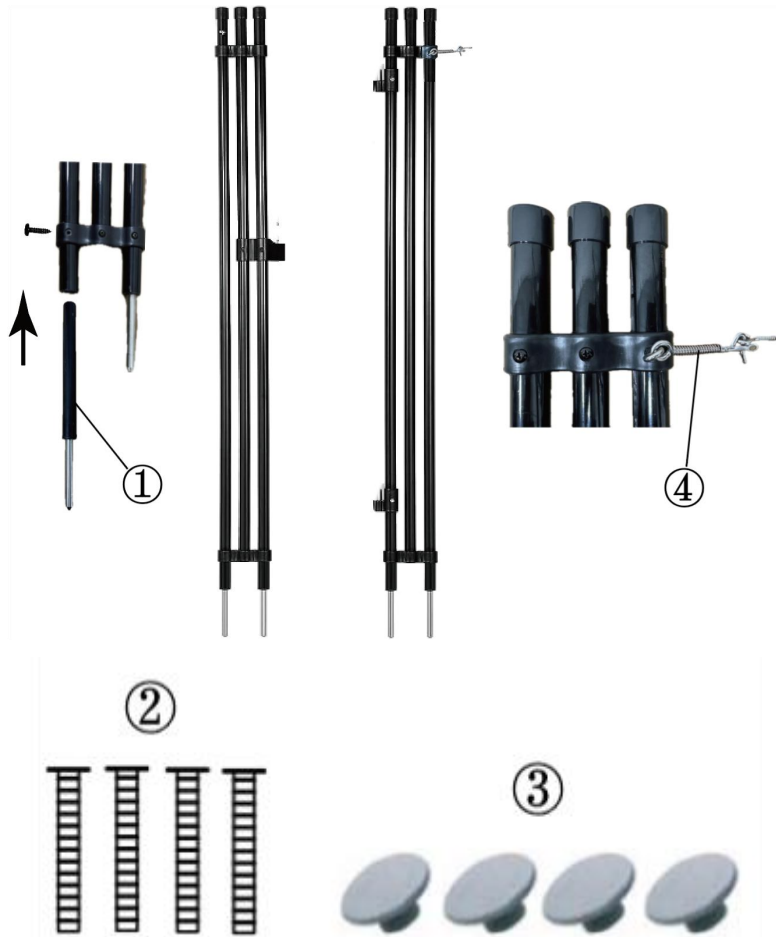

Step 3: Mark the position of the mounting holes with the template for hole placement.

NOTE: The two holes on the left and right sides are used to install the fence adjacent to the door.

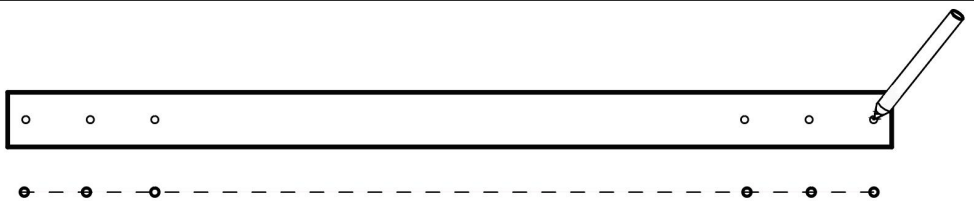

Step 4:Drilling

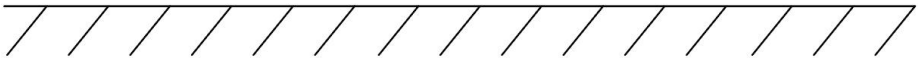
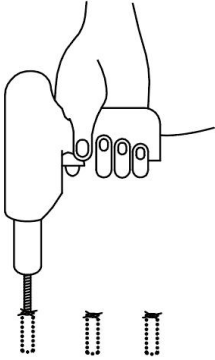

Step 5:Install the peg

Sleeving: Once drilling is completed, flush out the debris from the holes using a garden hose. Next insert the plastic sleeves in the holes and tap down completely .

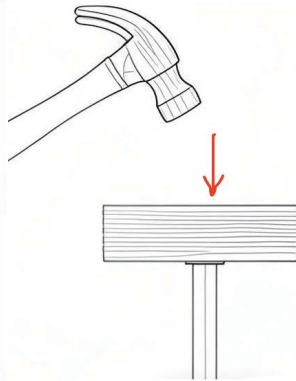
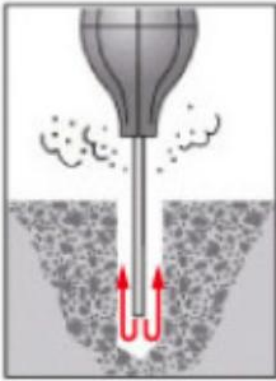

Tip:To avoid damaging the sleeve, place a piece of wood on top of the sleeve as illustrated,and gently hammer the sleeve down into the hole until it sinks into the ground.

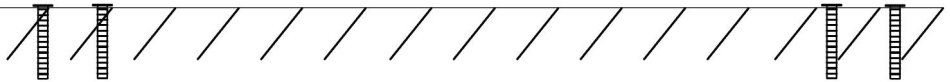

Step 6:Insert the left and right gate post into the pegs then ,install the gate to complete the installation.

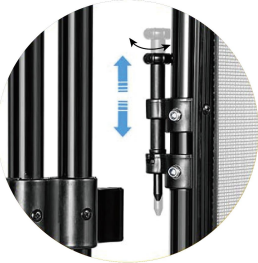
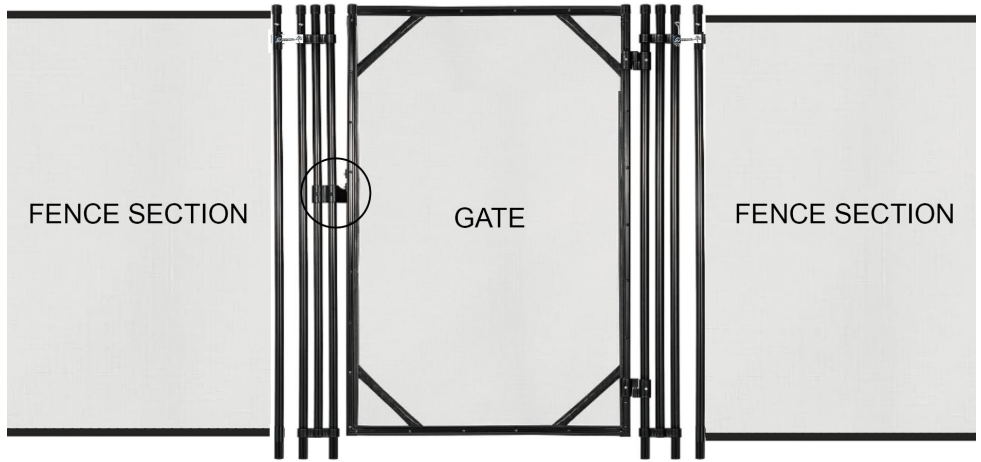

Turn and pull the lock to open the door lock, operate in the opposite direction to lock the door.

Note: This product does not include the fence part, which needs to be purchased and installed separately.

WARNING: THE POLE CANNOT BE REMOVED IF YOU SIMPLY PULL WITHOUT TURNING IT AT THE SAME TIME. IT IS IMPERATIVE THAT ACCESS POINTS ARE CLOSED AT THE END OF THE SEASON OF SUPERVISED SWIMMING.

3. Maintenance

Try to regularly monitor all safety fence components. If any of the components should be damaged, especially those relating to closing, please contact the shop where you purchased the barrier immediately in order to obtain a replacement part. It is imperative to replace the elements or groups of elements that are damaged as soon as possible. Do not use parts that are not officially approved by the PROVIDER/ INSTALLER.

SAFETY PRECAUTIONS

- THE SWIMMING POOL CAN BE A HAZARD TO YOUR CHILDREN. DROWNING MAY HAPPEN VERY QUICKLY. WHEN CHILDREN ARE NEAR THE POOL THEY REQUIRE CONSTANT AND ACTIVE SUPERVISION, EVEN IF THEY ARE ABLE TO SWIM.

- THIS BARRIER DOES NOT REPLACE COMMON SENSE OR INDIVIDUAL RESPONSIBILITY. THE BARRIER CANNOT REPLACE SUPERVISION CARRIED OUT BY RESPONSIBLE ADULTS WHICH STILL REMAINS THE KEY FACTOR IN PROTECTING SMALL CHILDREN.
- POINTS OF ACCESS MUST BE CLOSED SYSTEMATICALLY WHEN NO ONE IS HOME, EVEN IF IT IS FOR A SHORT PERIOD OF TIME.
- WARNING! SAFETY IS GUARANTEED ONLY WHEN POINTS OF ACCESS ARE LOCKED.
- CHECK WHETHER THERE ARE ELEMENTS NEAR THE BARRIER THAT COULD ENABLE OR FACILITATE CLIMBING THE FENCE.
- CLOSING POINTS OF ACCESS THROUGH AUTOMATED CLOSING SYSTEMS SHOULD BE CHECKED SYSTEMATICALLY.
- WHEN THE BARRIER IS BROKEN OR DAMAGED AND REQUIRES REPAIR WORK, IT IS VERY IMPORTANT TO INCREASE SUPERVISION TO PREVENT SMALL CHILDREN FROM ACCESSING THE POOL.



- LEARN RESCUE TECHNIQUES (CARDIOPULMONARY RESUSCITATION) AND UPDATE YOUR KNOWLEDGE PERIODICALLY. IT COULD SAVE A LIFE IN AN EMERGENCY.

- THE PRESENCE OF PARENTS AND/OR OTHER RESPONSIBLE ADULTS IS REQUIRED WHEN THE POOL IS ACCESSIBLE.

MEMORIZE AND DISPLAY NEAR THE POOL THE FIRST AID NUMBERS.

FIREFIGHTERS

EMERGENCY MEDICAL SERVICES

POISON CONTROL CENTER

Manufacturer: Shanghaimuxinmuyeyouxiangongsi

Address: Shuangchenglu 803nong11hao1602A-1609shi, baoshanqu, shanghai 200000 CN.

Imported to AUS: SIHAO PTY LTD. 1 ROKEVA STREETEASTWOOD NSW 2122 Australia

Imported to USA: Sanven Technology Ltd. Suite 250, 9166 Anaheim Place, Rancho Cucamonga, CA 91730

UK	REP
-----------	------------

YH CONSULTING LIMITED. C/O YH Consulting Limited Office 147, Centurion House, London Road, Staines-upon-Thames, Surrey, TW18 4AX

EC	REP
-----------	------------

E-CrossStu GmbH
Mainzer Landstr.69,
60329 Frankfurt am Main.

VEVOR[®]

TOUGH TOOLS, HALF PRICE

Technical Support and E-Warranty Certificate

www.vevor.com/support

VEVOR[®]

TOUGH TOOLS, HALF PRICE

Technical Support and E-Warranty Certificate www.vevor.com/support

POOL GATE

MODEL:NLGTR01

We continue to be committed to provide you tools with competitive price.

"Save Half", "Half Price" or any other similar expressions used by us only represents an estimate of savings you might benefit from buying certain tools with us compared to the major top brands and does not necessarily mean to cover all categories of tools offered by us. You are kindly reminded to verify carefully when you are placing an order with us if you are actually saving half in comparison with the top major brands.

VEVOR®

TOUGH TOOLS, HALF PRICE

Pool GATE

Model:NLGTR01



NEED HELP? CONTACT US!

Have product questions? Need technical support? Please feel free to contact us:
Technical Support and E-Warranty Certificate www.vevor.com/support

This is the original instruction, please read all manual instructions carefully before operating. VEVOR reserves a clear interpretation of our user manual. The appearance of the product shall be subject to the product you received. Please forgive us that we won't inform you again if there are any technology or software updates on our product.

BEFORE YOU START:

Please read the instructions in their entirety prior to installation to ensure a smooth and proper installation. Retain the manual for future reference.

SPECIFICATIONS

Model	NLGTR01
Product Size	4*2.5ft
Color	Black

Required tools

1.Utility knife
2.Rotary hammer drill
3.5/8" SDS masonry drill bit
4.1/4" Phillips Head screwdriver
5.Extension cord
6.Measuring tape
7.Pencil or white chalk
8.Hammer or rubber mallet
9.Square and level

PARTS LIST

			
<p>Left gate post ×1</p>	<p>Gate ×1</p>	<p>Right gate post ×1</p>	
			
<p>① Pin ×4</p>	<p>② Peg ×4</p>	<p>③ Peg cover ×4</p>	<p>④ Gate hook</p>
			
<p>Template for hole placement ×1</p>			

Installation

Step 1: Install the pin

Step 2: Install the Gate hook

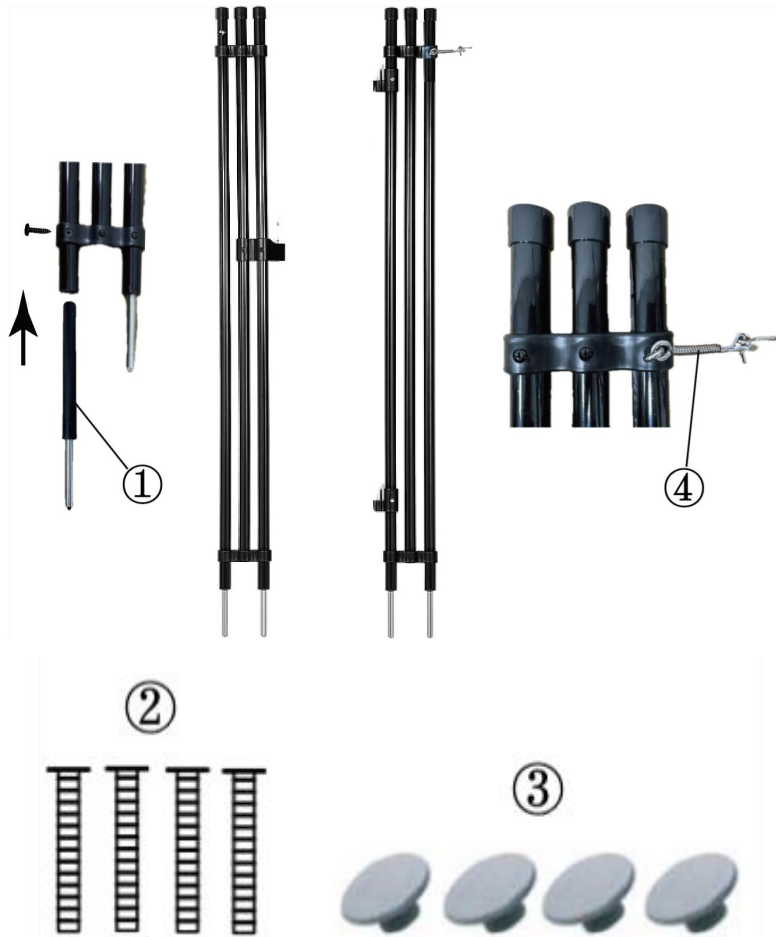

Step 3: Mark the position of the mounting holes with the template for hole placement.

NOTE: The two holes on the left and right sides are used to install the fence adjacent to the door.

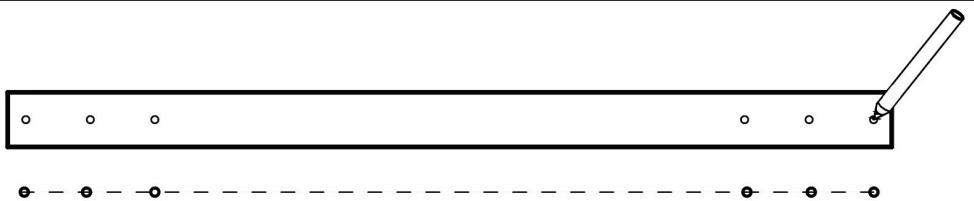

Step 4:Drilling

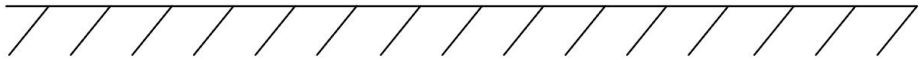
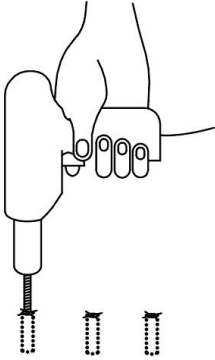

Step 5:Install the peg

Sleeving: Once drilling is completed, flush out the debris from the holes using a garden hose. Next insert the plastic sleeves in the holes and tap down completely .

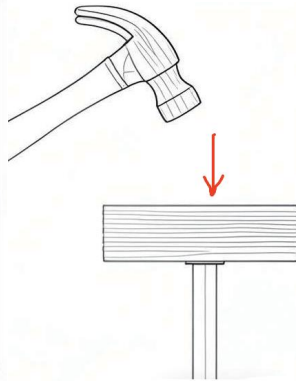
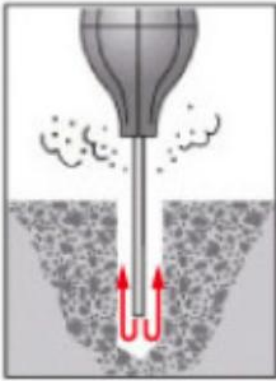

Tip:To avoid damaging the sleeve, place a piece of wood on top of the sleeve as illustrated,and gently hammer the sleeve down into the hole until it sinks into the ground.

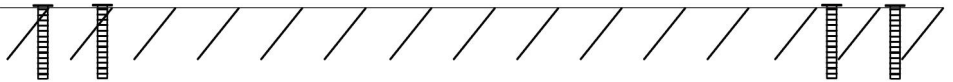

Step 6:Insert the left and right gate post into the pegs then ,install the gate to complete the installation.

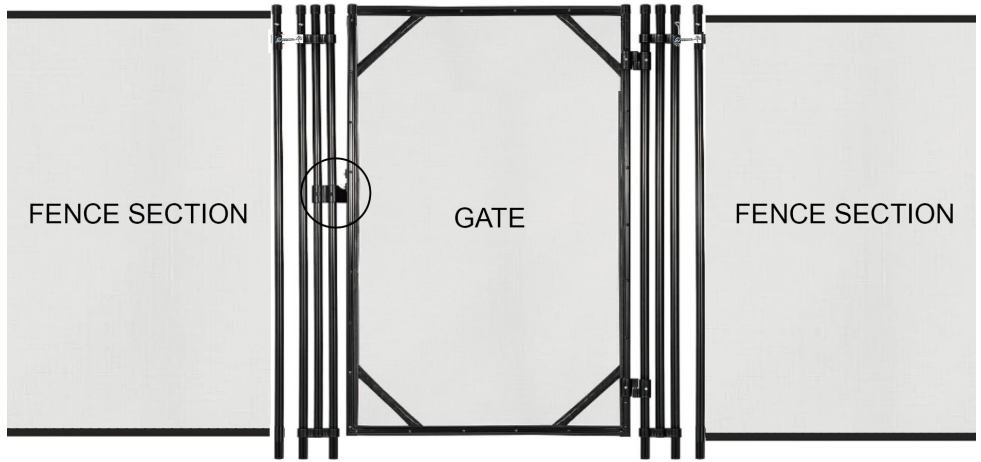

Turn and pull the lock to open the door lock, operate in the opposite direction to lock the door.

Note: This product does not include the fence part, which needs to be purchased and installed separately.

WARNING: THE POLE CANNOT BE REMOVED IF YOU SIMPLY PULL WITHOUT TURNING IT AT THE SAME TIME. IT IS IMPERATIVE THAT ACCESS POINTS ARE CLOSED AT THE END OF THE SEASON OF SUPERVISED SWIMMING.

4. Maintenance

Try to regularly monitor all safety fence components. If any of the components should be damaged, especially those relating to closing, please contact the shop where you purchased the barrier immediately in order to obtain a replacement part. It is imperative to replace the elements or groups of elements that are damaged as soon as possible. Do not use parts that are not officially approved by the PROVIDER/ INSTALLER.

SAFETY PRECAUTIONS

- THE SWIMMING POOL CAN BE A HAZARD TO YOUR CHILDREN. DROWNING MAY HAPPEN VERY QUICKLY. WHEN CHILDREN ARE NEAR THE POOL THEY REQUIRE CONSTANT AND ACTIVE SUPERVISION, EVEN IF THEY ARE ABLE TO SWIM.

- THIS BARRIER DOES NOT REPLACE COMMON SENSE OR INDIVIDUAL RESPONSIBILITY. THE BARRIER CANNOT REPLACE SUPERVISION CARRIED OUT BY RESPONSIBLE ADULTS WHICH STILL REMAINS THE KEY FACTOR IN PROTECTING SMALL CHILDREN.
- POINTS OF ACCESS MUST BE CLOSED SYSTEMATICALLY WHEN NO ONE IS HOME, EVEN IF IT IS FOR A SHORT PERIOD OF TIME.
- WARNING! SAFETY IS GUARANTEED ONLY WHEN POINTS OF ACCESS ARE LOCKED.
- CHECK WHETHER THERE ARE ELEMENTS NEAR THE BARRIER THAT COULD ENABLE OR FACILITATE CLIMBING THE FENCE.
- CLOSING POINTS OF ACCESS THROUGH AUTOMATED CLOSING SYSTEMS SHOULD BE CHECKED SYSTEMATICALLY.
- WHEN THE BARRIER IS BROKEN OR DAMAGED AND REQUIRES REPAIR WORK, IT IS VERY IMPORTANT TO INCREASE SUPERVISION TO PREVENT SMALL CHILDREN FROM ACCESSING THE POOL.



- LEARN RESCUE TECHNIQUES (CARDIOPULMONARY RESUSCITATION) AND UPDATE YOUR KNOWLEDGE PERIODICALLY. IT COULD SAVE A LIFE IN AN EMERGENCY.

- THE PRESENCE OF PARENTS AND/OR OTHER RESPONSIBLE ADULTS IS REQUIRED WHEN THE POOL IS ACCESSIBLE.

MEMORIZE AND DISPLAY NEAR THE POOL THE FIRST AID NUMBERS.

FIREFIGHTERS

EMERGENCY MEDICAL SERVICES

POISON CONTROL CENTER

Manufacturer: Shanghaimuxinmuyeyouxiangongsi

Address: Shuangchenglu 803nong11hao1602A-1609shi, baoshanqu, shanghai 200000 CN.

Imported to AUS: SIHAO PTY LTD. 1 ROKEVA STREETEASTWOOD NSW 2122 Australia

Imported to USA: Sanven Technology Ltd. Suite 250, 9166 Anaheim Place, Rancho Cucamonga, CA 91730

UK	REP
-----------	------------

YH CONSULTING LIMITED. C/O YH Consulting Limited Office 147, Centurion House, London Road, Staines-upon-Thames, Surrey, TW18 4AX

EC	REP
-----------	------------

E-CrossStu GmbH
Mainzer Landstr.69,
60329 Frankfurt am Main.

VEVOR[®]

TOUGH TOOLS, HALF PRICE

Technical Support and E-Warranty Certificate

www.vevor.com/support

VEVOR[®]

TOUGH TOOLS, HALF PRICE

Technical Support and E-Warranty Certificate www.vevor.com/support

POOL GATE

MODEL:NLGTR01

We continue to be committed to provide you tools with competitive price.

"Save Half", "Half Price" or any other similar expressions used by us only represents an estimate of savings you might benefit from buying certain tools with us compared to the major top brands and does not necessarily mean to cover all categories of tools offered by us. You are kindly reminded to verify carefully when you are placing an order with us if you are actually saving half in comparison with the top major brands.

VEVOR[®]

TOUGH TOOLS, HALF PRICE

Pool GATE

Model:NLGTR01



NEED HELP? CONTACT US!

Have product questions? Need technical support? Please feel free to contact us:
Technical Support and E-Warranty Certificate www.vevor.com/support

This is the original instruction, please read all manual instructions carefully before operating. VEVOR reserves a clear interpretation of our user manual. The appearance of the product shall be subject to the product you received. Please forgive us that we won't inform you again if there are any technology or software updates on our product.

BEFORE YOU START:

Please read the instructions in their entirety prior to installation to ensure a smooth and proper installation. Retain the manual for future reference.

SPECIFICATIONS

Model	NLGTR01
Product Size	4*2.5ft
Color	Black

Required tools

1.Utility knife
2.Rotary hammer drill
3.5/8" SDS masonry drill bit
4.1/4" Phillips Head screwdriver
5.Extension cord
6.Measuring tape
7.Pencil or white chalk
8.Hammer or rubber mallet
9.Square and level

PARTS LIST

			
<p>Left gate post ×1</p>	<p>Gate ×1</p>	<p>Right gate post ×1</p>	
			
<p>① Pin ×4</p>	<p>② Peg ×4</p>	<p>③ Peg cover ×4</p>	<p>④ Gate hook</p>
			
<p>Template for hole placement ×1</p>			

Installation

Step 1: Install the pin

Step 2: Install the Gate hook

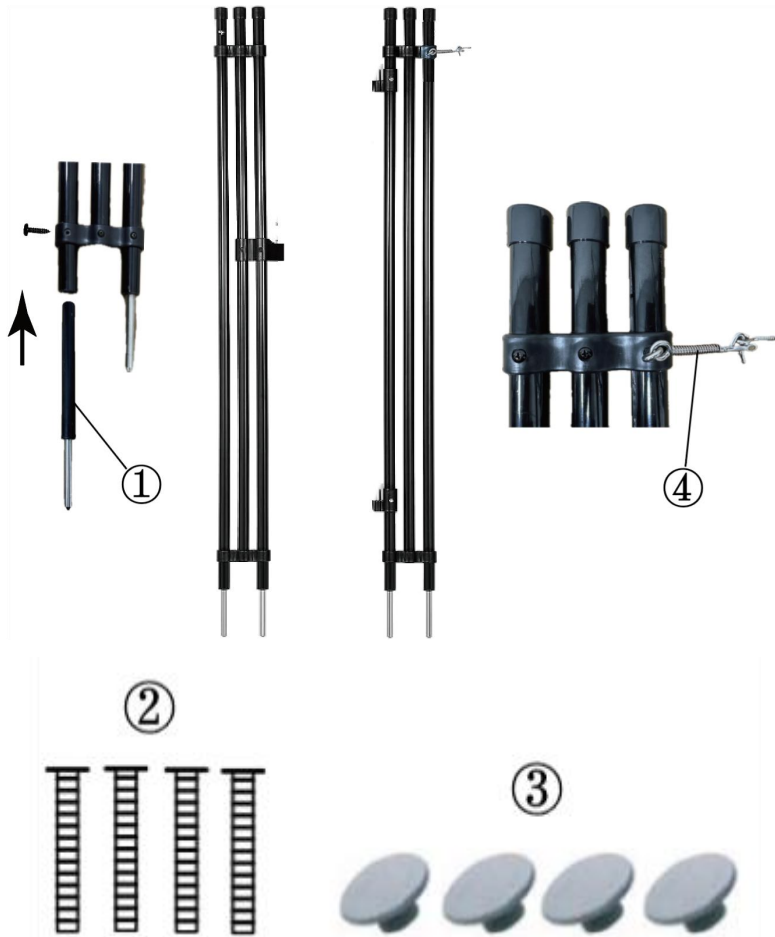

Step 3: Mark the position of the mounting holes with the template for hole placement.

NOTE: The two holes on the left and right sides are used to install the fence adjacent to the door.

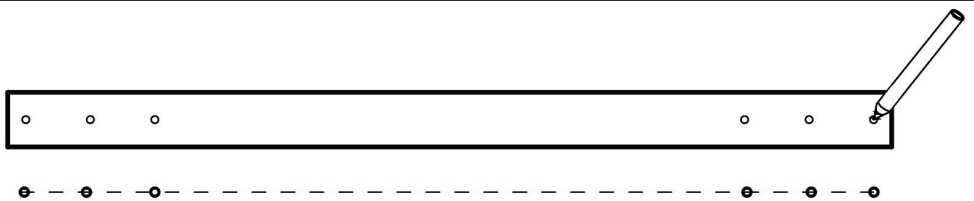

Step 4:Drilling

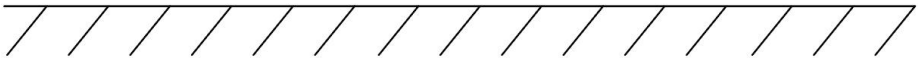
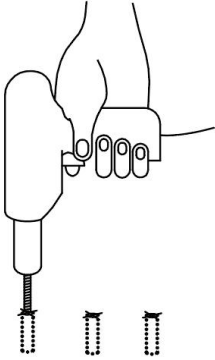

Step 5:Install the peg

Sleeving: Once drilling is completed, flush out the debris from the holes using a garden hose. Next insert the plastic sleeves in the holes and tap down completely .

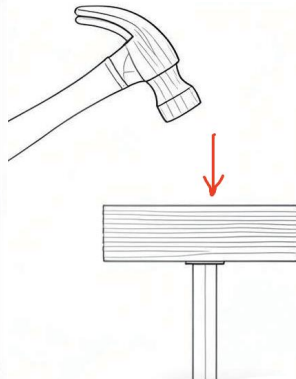
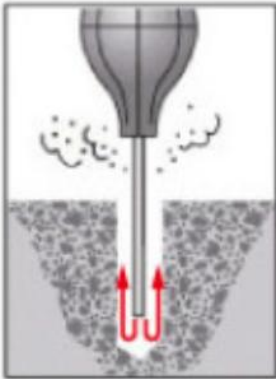

Tip:To avoid damaging the sleeve, place a piece of wood on top of the sleeve as illustrated,and gently hammer the sleeve down into the hole until it sinks into the ground.

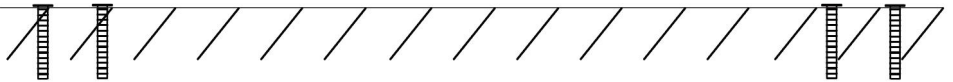

Step 6:Insert the left and right gate post into the pegs then ,install the gate to complete the installation.

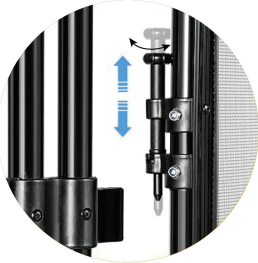
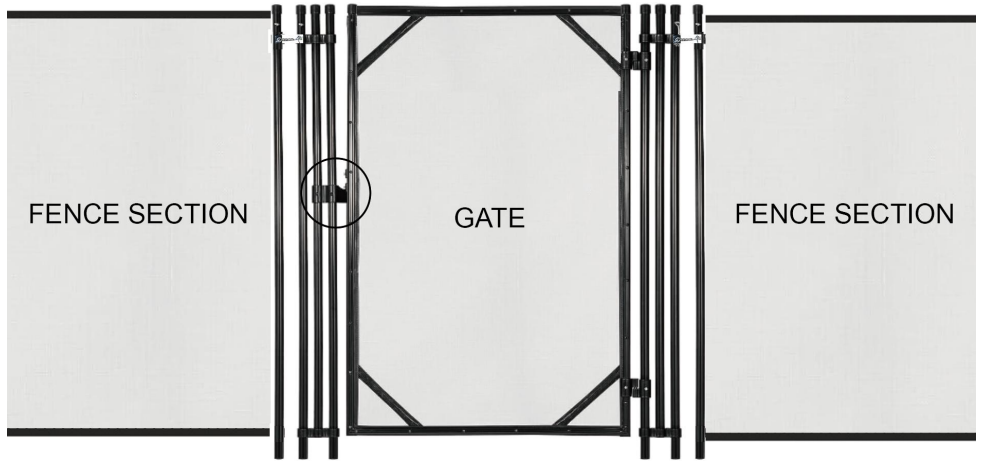

Turn and pull the lock to open the door lock, operate in the opposite direction to lock the door.

Note: This product does not include the fence part, which needs to be purchased and installed separately.

WARNING: THE POLE CANNOT BE REMOVED IF YOU SIMPLY PULL WITHOUT TURNING IT AT THE SAME TIME. IT IS IMPERATIVE THAT ACCESS POINTS ARE CLOSED AT THE END OF THE SEASON OF SUPERVISED SWIMMING.

5. Maintenance

Try to regularly monitor all safety fence components. If any of the components should be damaged, especially those relating to closing, please contact the shop where you purchased the barrier immediately in order to obtain a replacement part. It is imperative to replace the elements or groups of elements that are damaged as soon as possible. Do not use parts that are not officially approved by the PROVIDER/ INSTALLER.

SAFETY PRECAUTIONS

- THE SWIMMING POOL CAN BE A HAZARD TO YOUR CHILDREN. DROWNING MAY HAPPEN VERY QUICKLY. WHEN CHILDREN ARE NEAR THE POOL THEY REQUIRE CONSTANT AND ACTIVE SUPERVISION, EVEN IF THEY ARE ABLE TO SWIM.

- THIS BARRIER DOES NOT REPLACE COMMON SENSE OR INDIVIDUAL RESPONSIBILITY. THE BARRIER CANNOT REPLACE SUPERVISION CARRIED OUT BY RESPONSIBLE ADULTS WHICH STILL REMAINS THE KEY FACTOR IN PROTECTING SMALL CHILDREN.
- POINTS OF ACCESS MUST BE CLOSED SYSTEMATICALLY WHEN NO ONE IS HOME, EVEN IF IT IS FOR A SHORT PERIOD OF TIME.
- WARNING! SAFETY IS GUARANTEED ONLY WHEN POINTS OF ACCESS ARE LOCKED.
- CHECK WHETHER THERE ARE ELEMENTS NEAR THE BARRIER THAT COULD ENABLE OR FACILITATE CLIMBING THE FENCE.
- CLOSING POINTS OF ACCESS THROUGH AUTOMATED CLOSING SYSTEMS SHOULD BE CHECKED SYSTEMATICALLY.
- WHEN THE BARRIER IS BROKEN OR DAMAGED AND REQUIRES REPAIR WORK, IT IS VERY IMPORTANT TO INCREASE SUPERVISION TO PREVENT SMALL CHILDREN FROM ACCESSING THE POOL.



- LEARN RESCUE TECHNIQUES (CARDIOPULMONARY RESUSCITATION) AND UPDATE YOUR KNOWLEDGE PERIODICALLY. IT COULD SAVE A LIFE IN AN EMERGENCY.

- THE PRESENCE OF PARENTS AND/OR OTHER RESPONSIBLE ADULTS IS REQUIRED WHEN THE POOL IS ACCESSIBLE.

MEMORIZE AND DISPLAY NEAR THE POOL THE FIRST AID NUMBERS.

FIREFIGHTERS

EMERGENCY MEDICAL SERVICES

POISON CONTROL CENTER

Manufacturer: Shanghaimuxinmuyeyouxiangongsi

Address: Shuangchenglu 803nong11hao1602A-1609shi, baoshanqu, shanghai 200000 CN.

Imported to AUS: SIHAO PTY LTD. 1 ROKEVA STREETEASTWOOD NSW 2122 Australia

Imported to USA: Sanven Technology Ltd. Suite 250, 9166 Anaheim Place, Rancho Cucamonga, CA 91730

UK	REP
-----------	------------

YH CONSULTING LIMITED. C/O YH Consulting Limited Office 147, Centurion House, London Road, Staines-upon-Thames, Surrey, TW18 4AX

EC	REP
-----------	------------

E-CrossStu GmbH
Mainzer Landstr.69,
60329 Frankfurt am Main.

VEVOR[®]

TOUGH TOOLS, HALF PRICE

Technical Support and E-Warranty Certificate

www.vevor.com/support

VEVOR[®]

TOUGH TOOLS, HALF PRICE

Technical Support and E-Warranty Certificate www.vevor.com/support

POOL GATE

MODEL:NLGTR01

We continue to be committed to provide you tools with competitive price.

"Save Half", "Half Price" or any other similar expressions used by us only represents an estimate of savings you might benefit from buying certain tools with us compared to the major top brands and does not necessarily mean to cover all categories of tools offered by us. You are kindly reminded to verify carefully when you are placing an order with us if you are actually saving half in comparison with the top major brands.

VEVOR®

TOUGH TOOLS, HALF PRICE

Pool GATE

Model:NLGTR01



NEED HELP? CONTACT US!

Have product questions? Need technical support? Please feel free to contact us:
Technical Support and E-Warranty Certificate www.vevor.com/support

This is the original instruction, please read all manual instructions carefully before operating. VEVOR reserves a clear interpretation of our user manual. The appearance of the product shall be subject to the product you received. Please forgive us that we won't inform you again if there are any technology or software updates on our product.

BEFORE YOU START:

Please read the instructions in their entirety prior to installation to ensure a smooth and proper installation. Retain the manual for future reference.

SPECIFICATIONS

Model	NLGTR01
Product Size	4*2.5ft
Color	Black

Required tools

1.Utility knife
2.Rotary hammer drill
3.5/8" SDS masonry drill bit
4.1/4" Phillips Head screwdriver
5.Extension cord
6.Measuring tape
7.Pencil or white chalk
8.Hammer or rubber mallet
9.Square and level

PARTS LIST

			
<p>Left gate post ×1</p>	<p>Gate ×1</p>	<p>Right gate post ×1</p>	
			
<p>① Pin ×4</p>	<p>② Peg ×4</p>	<p>③ Peg cover ×4</p>	<p>④ Gate hook</p>
			
<p>Template for hole placement ×1</p>			

Installation

Step 1: Install the pin

Step 2: Install the Gate hook

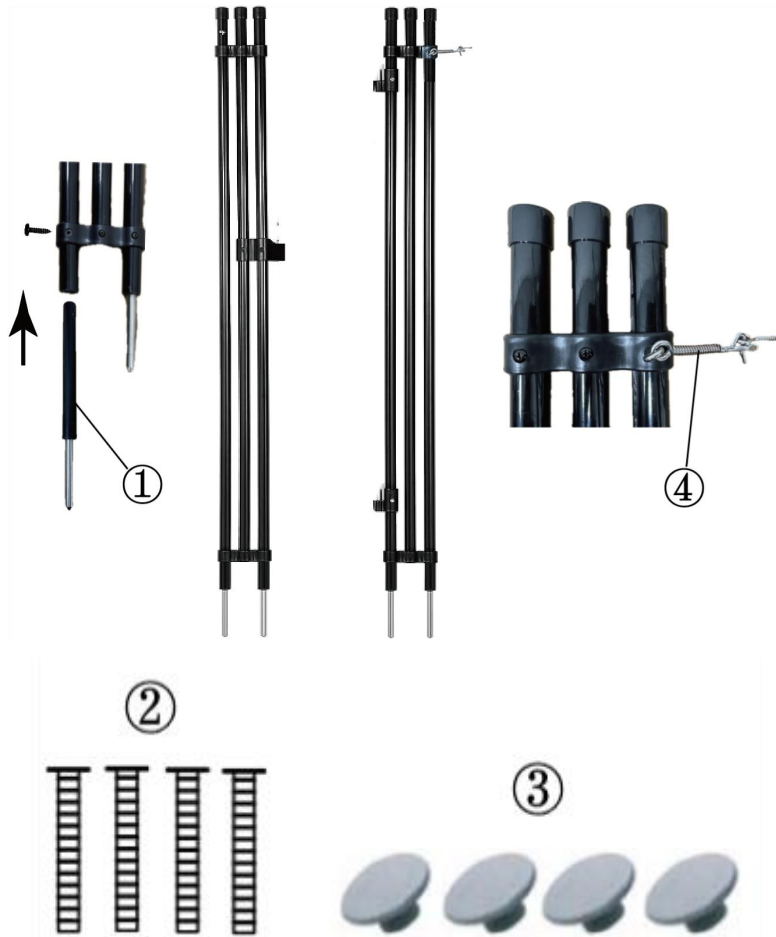

Step 3: Mark the position of the mounting holes with the template for hole placement.

NOTE: The two holes on the left and right sides are used to install the fence adjacent to the door.

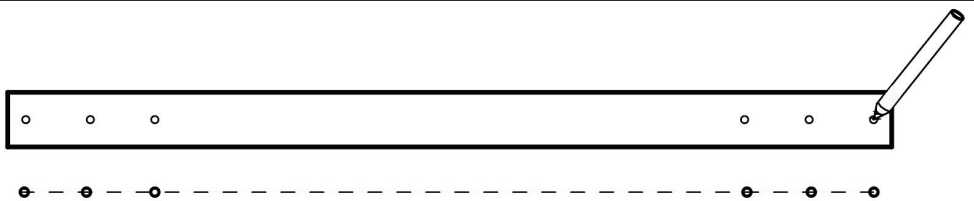

Step 4:Drilling

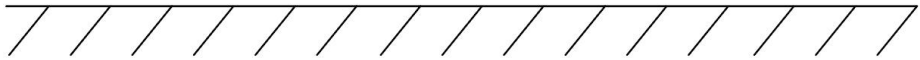
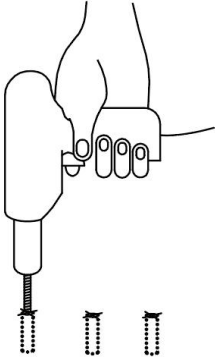

Step 5:Install the peg

Sleeving: Once drilling is completed, flush out the debris from the holes using a garden hose. Next insert the plastic sleeves in the holes and tap down completely .

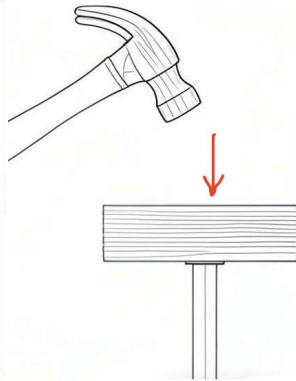
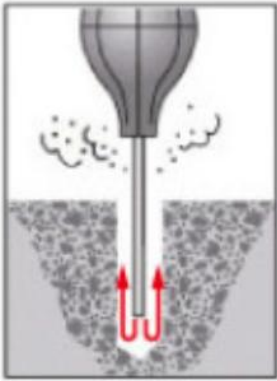

Tip:To avoid damaging the sleeve, place a piece of wood on top of the sleeve as illustrated,and gently hammer the sleeve down into the hole until it sinks into the ground.

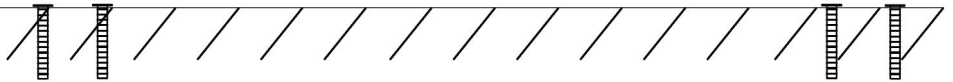

Step 6:Insert the left and right gate post into the pegs then ,install the gate to complete the installation.

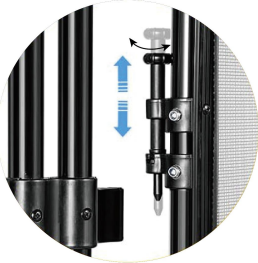

Turn and pull the lock to open the door lock, operate in the opposite direction to lock the door.

Note: This product does not include the fence part, which needs to be purchased and installed separately.

WARNING: THE POLE CANNOT BE REMOVED IF YOU SIMPLY PULL WITHOUT TURNING IT AT THE SAME TIME. IT IS IMPERATIVE THAT ACCESS POINTS ARE CLOSED AT THE END OF THE SEASON OF SUPERVISED SWIMMING.

6. Maintenance

Try to regularly monitor all safety fence components. If any of the components should be damaged, especially those relating to closing, please contact the shop where you purchased the barrier immediately in order to obtain a replacement part. It is imperative to replace the elements or groups of elements that are damaged as soon as possible. Do not use parts that are not officially approved by the PROVIDER/ INSTALLER.

SAFETY PRECAUTIONS

- THE SWIMMING POOL CAN BE A HAZARD TO YOUR CHILDREN. DROWNING MAY HAPPEN VERY QUICKLY. WHEN CHILDREN ARE NEAR THE POOL THEY REQUIRE CONSTANT AND ACTIVE SUPERVISION, EVEN IF THEY ARE ABLE TO SWIM.

- THIS BARRIER DOES NOT REPLACE COMMON SENSE OR INDIVIDUAL RESPONSIBILITY. THE BARRIER CANNOT REPLACE SUPERVISION CARRIED OUT BY RESPONSIBLE ADULTS WHICH STILL REMAINS THE KEY FACTOR IN PROTECTING SMALL CHILDREN.
- POINTS OF ACCESS MUST BE CLOSED SYSTEMATICALLY WHEN NO ONE IS HOME, EVEN IF IT IS FOR A SHORT PERIOD OF TIME.
- WARNING! SAFETY IS GUARANTEED ONLY WHEN POINTS OF ACCESS ARE LOCKED.
- CHECK WHETHER THERE ARE ELEMENTS NEAR THE BARRIER THAT COULD ENABLE OR FACILITATE CLIMBING THE FENCE.
- CLOSING POINTS OF ACCESS THROUGH AUTOMATED CLOSING SYSTEMS SHOULD BE CHECKED SYSTEMATICALLY.
- WHEN THE BARRIER IS BROKEN OR DAMAGED AND REQUIRES REPAIR WORK, IT IS VERY IMPORTANT TO INCREASE SUPERVISION TO PREVENT SMALL CHILDREN FROM ACCESSING THE POOL.



- LEARN RESCUE TECHNIQUES (CARDIOPULMONARY RESUSCITATION) AND UPDATE YOUR KNOWLEDGE PERIODICALLY. IT COULD SAVE A LIFE IN AN EMERGENCY.
- THE PRESENCE OF PARENTS AND/OR OTHER RESPONSIBLE ADULTS IS REQUIRED WHEN THE POOL IS ACCESSIBLE.

MEMORIZE AND DISPLAY NEAR THE POOL THE FIRST AID NUMBERS.

FIREFIGHTERS

EMERGENCY MEDICAL SERVICES

POISON CONTROL CENTER

Manufacturer: Shanghaimuxinmuyeyouxiangongsi

Address: Shuangchenglu 803nong11hao1602A-1609shi, baoshanqu, shanghai 200000 CN.

Imported to AUS: SIHAO PTY LTD. 1 ROKEVA STREETEASTWOOD NSW 2122 Australia

Imported to USA: Sanven Technology Ltd. Suite 250, 9166 Anaheim Place, Rancho Cucamonga, CA 91730

UK	REP
-----------	------------

YH CONSULTING LIMITED. C/O YH Consulting Limited Office 147, Centurion House, London Road, Staines-upon-Thames, Surrey, TW18 4AX

EC	REP
-----------	------------

E-CrossStu GmbH
Mainzer Landstr.69,
60329 Frankfurt am Main.

VEVOR[®]

TOUGH TOOLS, HALF PRICE

Technical Support and E-Warranty Certificate

www.vevor.com/support

VEVOR[®]

TOUGH TOOLS, HALF PRICE

Technical Support and E-Warranty Certificate www.vevor.com/support

POOL GATE

MODEL:NLGTR01

We continue to be committed to provide you tools with competitive price.

"Save Half", "Half Price" or any other similar expressions used by us only represents an estimate of savings you might benefit from buying certain tools with us compared to the major top brands and does not necessarily mean to cover all categories of tools offered by us. You are kindly reminded to verify carefully when you are placing an order with us if you are actually saving half in comparison with the top major brands.

VEVOR®

TOUGH TOOLS, HALF PRICE

Pool GATE

Model:NLGTR01



NEED HELP? CONTACT US!

Have product questions? Need technical support? Please feel free to contact us:
Technical Support and E-Warranty Certificate www.vevor.com/support

This is the original instruction, please read all manual instructions carefully before operating. VEVOR reserves a clear interpretation of our user manual. The appearance of the product shall be subject to the product you received. Please forgive us that we won't inform you again if there are any technology or software updates on our product.

BEFORE YOU START:

Please read the instructions in their entirety prior to installation to ensure a smooth and proper installation. Retain the manual for future reference.

SPECIFICATIONS

Model	NLGTR01
Product Size	4*2.5ft
Color	Black

Required tools

1.Utility knife
2.Rotary hammer drill
3.5/8" SDS masonry drill bit
4.1/4" Phillips Head screwdriver
5.Extension cord
6.Measuring tape
7.Pencil or white chalk
8.Hammer or rubber mallet
9.Square and level

PARTS LIST

			
<p>Left gate post ×1</p>	<p>Gate ×1</p>	<p>Right gate post ×1</p>	
			
<p>① Pin ×4</p>	<p>② Peg ×4</p>	<p>③ Peg cover ×4</p>	<p>④ Gate hook</p>
			
<p>Template for hole placement ×1</p>			

Installation

Step 1: Install the pin

Step 2: Install the Gate hook

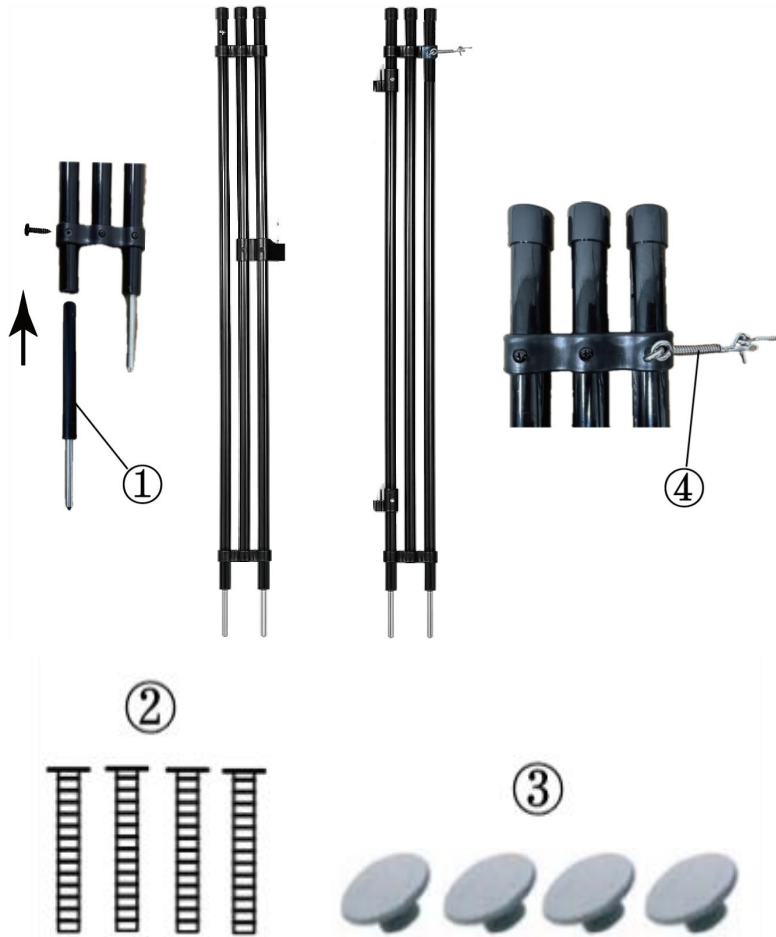

Step 3: Mark the position of the mounting holes with the template for hole placement.

NOTE: The two holes on the left and right sides are used to install the fence adjacent to the door.

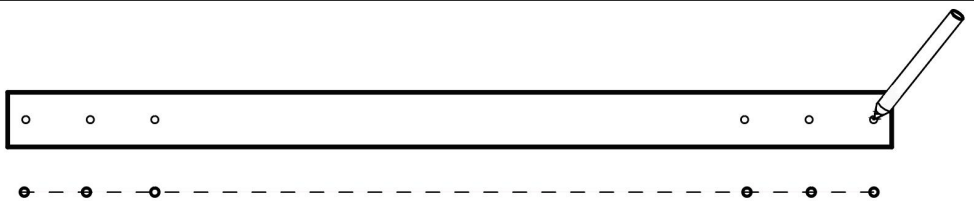

Step 4:Drilling

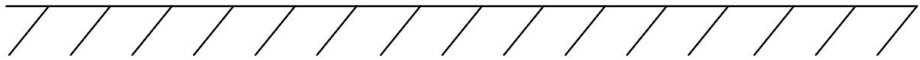
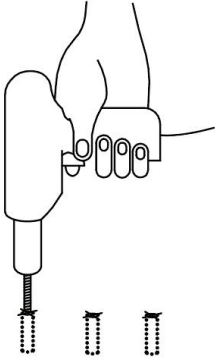

Step 5:Install the peg

Sleeving: Once drilling is completed, flush out the debris from the holes using a garden hose. Next insert the plastic sleeves in the holes and tap down completely .

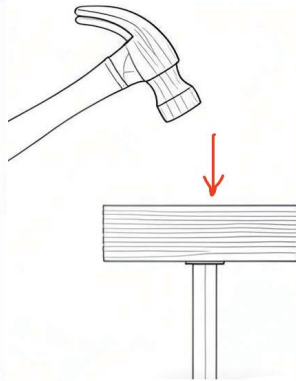
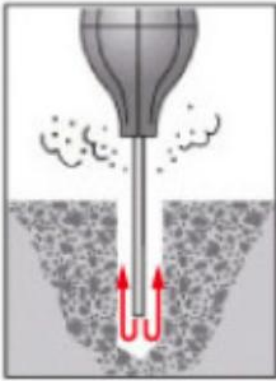

Tip:To avoid damaging the sleeve, place a piece of wood on top of the sleeve as illustrated,and gently hammer the sleeve down into the hole until it sinks into the ground.

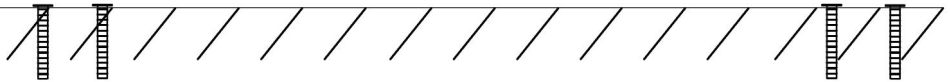

Step 6:Insert the left and right gate post into the pegs then ,install the gate to complete the installation.

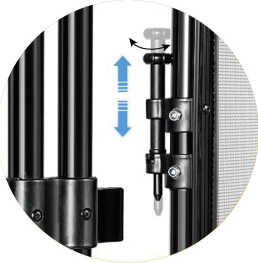
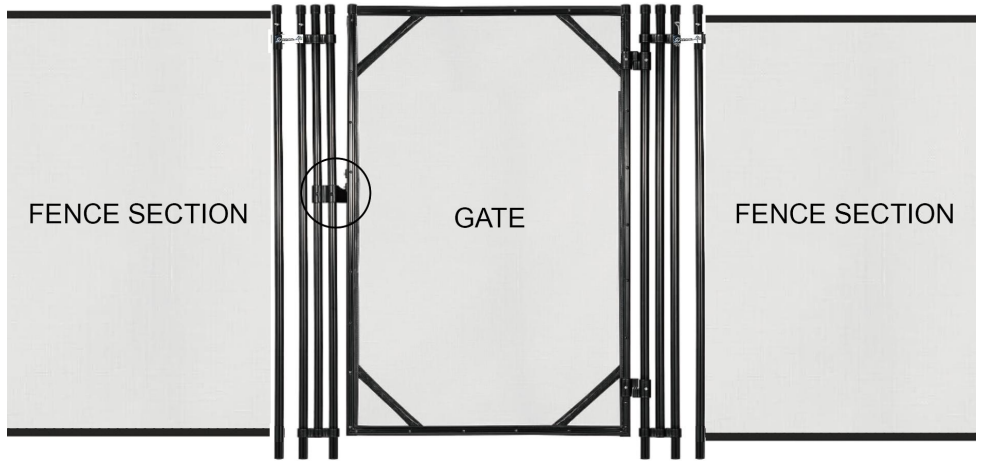

Turn and pull the lock to open the door lock, operate in the opposite direction to lock the door.

Note: This product does not include the fence part, which needs to be purchased and installed separately.

WARNING: THE POLE CANNOT BE REMOVED IF YOU SIMPLY PULL WITHOUT TURNING IT AT THE SAME TIME. IT IS IMPERATIVE THAT ACCESS POINTS ARE CLOSED AT THE END OF THE SEASON OF SUPERVISED SWIMMING.

7. Maintenance

Try to regularly monitor all safety fence components. If any of the components should be damaged, especially those relating to closing, please contact the shop where you purchased the barrier immediately in order to obtain a replacement part. It is imperative to replace the elements or groups of elements that are damaged as soon as possible. Do not use parts that are not officially approved by the PROVIDER/ INSTALLER.

SAFETY PRECAUTIONS

- THE SWIMMING POOL CAN BE A HAZARD TO YOUR CHILDREN. DROWNING MAY HAPPEN VERY QUICKLY. WHEN CHILDREN ARE NEAR THE POOL THEY REQUIRE CONSTANT AND ACTIVE SUPERVISION, EVEN IF THEY ARE ABLE TO SWIM.

- THIS BARRIER DOES NOT REPLACE COMMON SENSE OR INDIVIDUAL RESPONSIBILITY. THE BARRIER CANNOT REPLACE SUPERVISION CARRIED OUT BY RESPONSIBLE ADULTS WHICH STILL REMAINS THE KEY FACTOR IN PROTECTING SMALL CHILDREN.
- POINTS OF ACCESS MUST BE CLOSED SYSTEMATICALLY WHEN NO ONE IS HOME, EVEN IF IT IS FOR A SHORT PERIOD OF TIME.
- WARNING! SAFETY IS GUARANTEED ONLY WHEN POINTS OF ACCESS ARE LOCKED.
- CHECK WHETHER THERE ARE ELEMENTS NEAR THE BARRIER THAT COULD ENABLE OR FACILITATE CLIMBING THE FENCE.
- CLOSING POINTS OF ACCESS THROUGH AUTOMATED CLOSING SYSTEMS SHOULD BE CHECKED SYSTEMATICALLY.
- WHEN THE BARRIER IS BROKEN OR DAMAGED AND REQUIRES REPAIR WORK, IT IS VERY IMPORTANT TO INCREASE SUPERVISION TO PREVENT SMALL CHILDREN FROM ACCESSING THE POOL.



- LEARN RESCUE TECHNIQUES (CARDIOPULMONARY RESUSCITATION) AND UPDATE YOUR KNOWLEDGE PERIODICALLY. IT COULD SAVE A LIFE IN AN EMERGENCY.

- THE PRESENCE OF PARENTS AND/OR OTHER RESPONSIBLE ADULTS IS REQUIRED WHEN THE POOL IS ACCESSIBLE.

MEMORIZE AND DISPLAY NEAR THE POOL THE FIRST AID NUMBERS.

FIREFIGHTERS

EMERGENCY MEDICAL SERVICES

POISON CONTROL CENTER

Manufacturer: Shanghaimuxinmuyeyouxiangongsi

Address: Shuangchenglu 803nong11hao1602A-1609shi, baoshanqu, shanghai 200000 CN.

Imported to AUS: SIHAO PTY LTD. 1 ROKEVA STREETEASTWOOD NSW 2122 Australia

Imported to USA: Sanven Technology Ltd. Suite 250, 9166 Anaheim Place, Rancho Cucamonga, CA 91730

UK	REP
-----------	------------

YH CONSULTING LIMITED. C/O YH Consulting Limited Office 147, Centurion House, London Road, Staines-upon-Thames, Surrey, TW18 4AX

EC	REP
-----------	------------

E-CrossStu GmbH
Mainzer Landstr.69,
60329 Frankfurt am Main.

VEVOR[®]

TOUGH TOOLS, HALF PRICE

Technical Support and E-Warranty Certificate

www.vevor.com/support

VEVOR[®]

TOUGH TOOLS, HALF PRICE

Technical Support and E-Warranty Certificate www.vevor.com/support

POOL GATE

MODEL:NLGTR01

We continue to be committed to provide you tools with competitive price.

"Save Half", "Half Price" or any other similar expressions used by us only represents an estimate of savings you might benefit from buying certain tools with us compared to the major top brands and does not necessarily mean to cover all categories of tools offered by us. You are kindly reminded to verify carefully when you are placing an order with us if you are actually saving half in comparison with the top major brands.

VEVOR[®]

TOUGH TOOLS, HALF PRICE

Pool GATE

Model:NLGTR01



NEED HELP? CONTACT US!

Have product questions? Need technical support? Please feel free to contact us:
Technical Support and E-Warranty Certificate www.vevor.com/support

This is the original instruction, please read all manual instructions carefully before operating. VEVOR reserves a clear interpretation of our user manual. The appearance of the product shall be subject to the product you received. Please forgive us that we won't inform you again if there are any technology or software updates on our product.

BEFORE YOU START:

Please read the instructions in their entirety prior to installation to ensure a smooth and proper installation. Retain the manual for future reference.

SPECIFICATIONS

Model	NLGTR01
Product Size	4*2.5ft
Color	Black

Required tools

1.Utility knife
2.Rotary hammer drill
3.5/8" SDS masonry drill bit
4.1/4" Phillips Head screwdriver
5.Extension cord
6.Measuring tape
7.Pencil or white chalk
8.Hammer or rubber mallet
9.Square and level

PARTS LIST

			
<p>Left gate post ×1</p>	<p>Gate ×1</p>	<p>Right gate post ×1</p>	
			
<p>① Pin ×4</p>	<p>② Peg ×4</p>	<p>③ Peg cover ×4</p>	<p>④ Gate hook</p>
			
<p>Template for hole placement ×1</p>			

Installation

Step 1: Install the pin

Step 2: Install the Gate hook

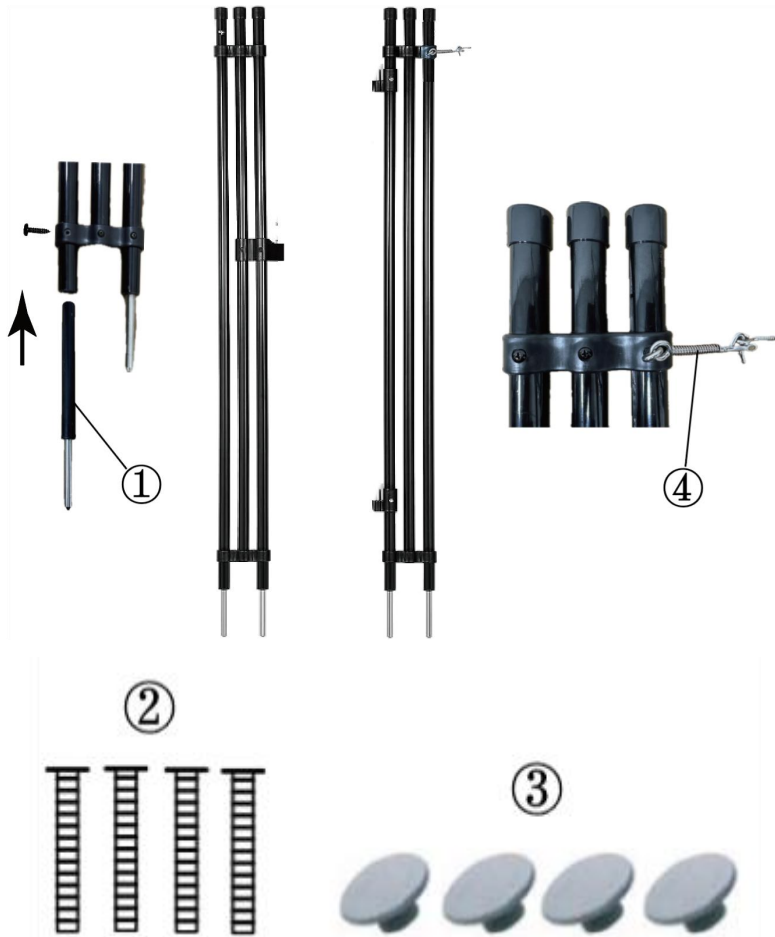

Step 3: Mark the position of the mounting holes with the template for hole placement.

NOTE: The two holes on the left and right sides are used to install the fence adjacent to the door.

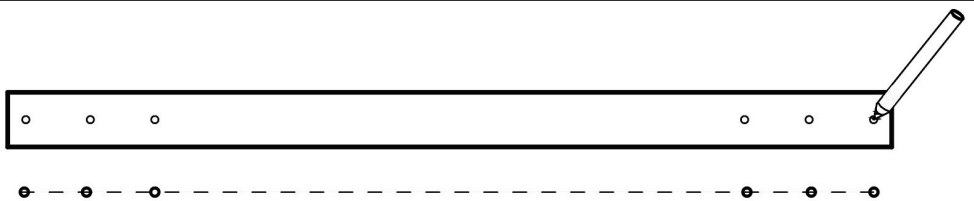

Step 4:Drilling

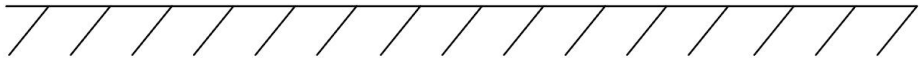
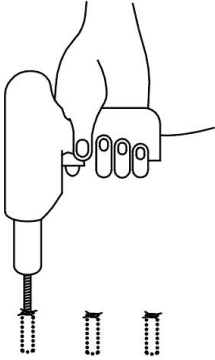

Step 5:Install the peg

Sleeving: Once drilling is completed, flush out the debris from the holes using a garden hose. Next insert the plastic sleeves in the holes and tap down completely .

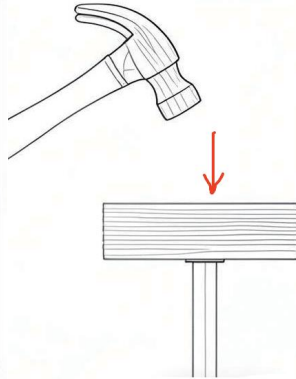
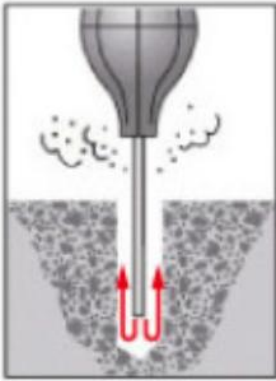

Tip:To avoid damaging the sleeve, place a piece of wood on top of the sleeve as illustrated,and gently hammer the sleeve down into the hole until it sinks into the ground.

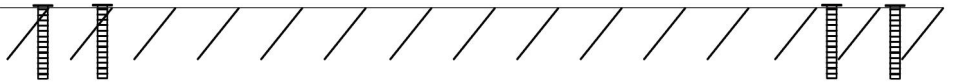

Step 6:Insert the left and right gate post into the pegs then ,install the gate to complete the installation.

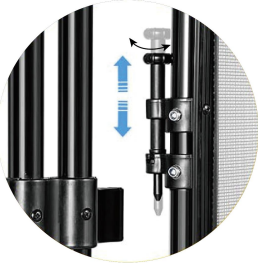
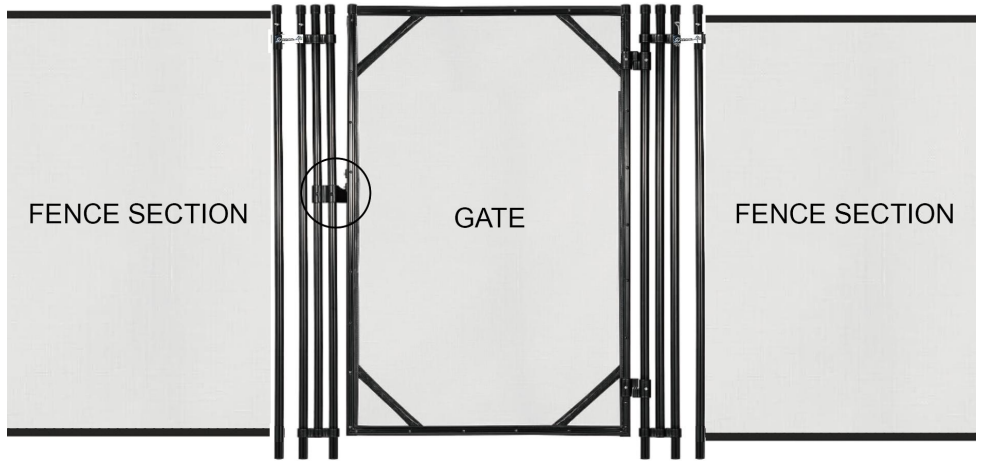

Turn and pull the lock to open the door lock, operate in the opposite direction to lock the door.

Note: This product does not include the fence part, which needs to be purchased and installed separately.

WARNING: THE POLE CANNOT BE REMOVED IF YOU SIMPLY PULL WITHOUT TURNING IT AT THE SAME TIME. IT IS IMPERATIVE THAT ACCESS POINTS ARE CLOSED AT THE END OF THE SEASON OF SUPERVISED SWIMMING.

8. Maintenance

Try to regularly monitor all safety fence components. If any of the components should be damaged, especially those relating to closing, please contact the shop where you purchased the barrier immediately in order to obtain a replacement part. It is imperative to replace the elements or groups of elements that are damaged as soon as possible. Do not use parts that are not officially approved by the PROVIDER/ INSTALLER.

SAFETY PRECAUTIONS

- THE SWIMMING POOL CAN BE A HAZARD TO YOUR CHILDREN. DROWNING MAY HAPPEN VERY QUICKLY. WHEN CHILDREN ARE NEAR THE POOL THEY REQUIRE CONSTANT AND ACTIVE SUPERVISION, EVEN IF THEY ARE ABLE TO SWIM.

- THIS BARRIER DOES NOT REPLACE COMMON SENSE OR INDIVIDUAL RESPONSIBILITY. THE BARRIER CANNOT REPLACE SUPERVISION CARRIED OUT BY RESPONSIBLE ADULTS WHICH STILL REMAINS THE KEY FACTOR IN PROTECTING SMALL CHILDREN.
- POINTS OF ACCESS MUST BE CLOSED SYSTEMATICALLY WHEN NO ONE IS HOME, EVEN IF IT IS FOR A SHORT PERIOD OF TIME.
- WARNING! SAFETY IS GUARANTEED ONLY WHEN POINTS OF ACCESS ARE LOCKED.
- CHECK WHETHER THERE ARE ELEMENTS NEAR THE BARRIER THAT COULD ENABLE OR FACILITATE CLIMBING THE FENCE.
- CLOSING POINTS OF ACCESS THROUGH AUTOMATED CLOSING SYSTEMS SHOULD BE CHECKED SYSTEMATICALLY.
- WHEN THE BARRIER IS BROKEN OR DAMAGED AND REQUIRES REPAIR WORK, IT IS VERY IMPORTANT TO INCREASE SUPERVISION TO PREVENT SMALL CHILDREN FROM ACCESSING THE POOL.



- LEARN RESCUE TECHNIQUES (CARDIOPULMONARY RESUSCITATION) AND UPDATE YOUR KNOWLEDGE PERIODICALLY. IT COULD SAVE A LIFE IN AN EMERGENCY.
- THE PRESENCE OF PARENTS AND/OR OTHER RESPONSIBLE ADULTS IS REQUIRED WHEN THE POOL IS ACCESSIBLE.

MEMORIZE AND DISPLAY NEAR THE POOL THE FIRST AID NUMBERS.

FIREFIGHTERS

EMERGENCY MEDICAL SERVICES

POISON CONTROL CENTER

Manufacturer: Shanghaimuxinmuyeyouxiangongsi

Address: Shuangchenglu 803nong11hao1602A-1609shi, baoshanqu, shanghai 200000 CN.

Imported to AUS: SIHAO PTY LTD. 1 ROKEVA STREETEASTWOOD NSW 2122 Australia

Imported to USA: Sanven Technology Ltd. Suite 250, 9166 Anaheim Place, Rancho Cucamonga, CA 91730

UK	REP
-----------	------------

YH CONSULTING LIMITED. C/O YH Consulting Limited Office 147, Centurion House, London Road, Staines-upon-Thames, Surrey, TW18 4AX

EC	REP
-----------	------------

E-CrossStu GmbH
Mainzer Landstr.69,
60329 Frankfurt am Main.

VEVOR[®]

TOUGH TOOLS, HALF PRICE

Technical Support and E-Warranty Certificate

www.vevor.com/support