

VEVOR

Affordable. Reliable. Home Improvement.

GROW TENT KIT

MODEL: HX8080180 HX100100200 HX120120200

VEVOR

Affordable. Reliable. Home Improvement.

GROW TENT KIT

MODEL: HX8080180 HX100100200 HX120120200

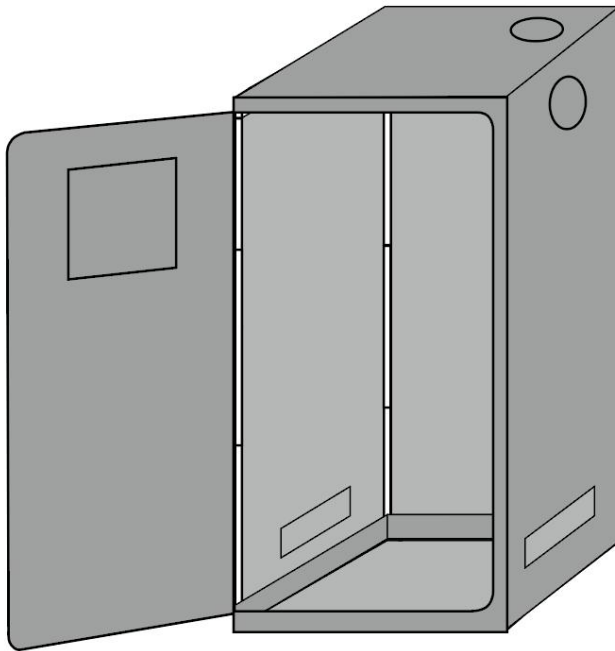



This is the original instruction, please read all manual instructions carefully before operating. VEVOR reserves a clear interpretation of our user manual. The appearance of the product shall be subject to the product you received. Please forgive us that we won't inform you again if there are any technology or software updates on our product.



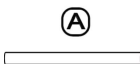

PRODUCT INSTRUCTIONS

WARNING:

- Please read through all instructions. If grow tent is improperly installed and/or maintained, there is potential for damage or possible injury or death.
- Use extreme care when handling sharp object in or around tent.
- Keep electrical wires safely away from equipment and areas in and or around the tent that may collect water.
- Do not hang equipment on or from grow tent that is above the supported weight range.
- Do not permit children to play on, in, or around grow tent.
- Do not use your grow tent if any part of your tent material is cracked, ripped, or broken.
- Do not place grow tent near a deck, stairs, chair, or other unsafe structure.
- Assemble correctly to avoid tent tipping over and causing injury.
- Do not expose grow tent to direct sunlight, near an open flame, or a heat source.
- Provide proper air circulation in your grow tent to prevent air from going stale.

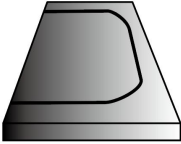
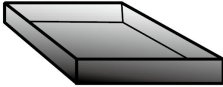
PARTS LIST

Product Code	HX8080180	HX100100200	HX120120200
Size	80X80X180cm	100X100X200cm	120X120X200cm
Parts			
 (A)	L 750 mmX11 PCS	L 950 mmX11 PCS	L1150 mmX11 PCS
 (B)	L 910 mmX4 PCS	L 1010 mmX4 PCS	L 1010 mmX4 PCS

	L 880 mmX4 PCS	L 980 mmX4 PCS	L 980 mmX4 PCS
 <p>Tent</p>	1 PCS	1 PCS	1 PCS
 <p>Floor Tray</p>	1 PCS	1 PCS	1 PCS
 <p>Corner Adapter</p>	8PCS	8PCS	8PCS
 <p>Filter Straps</p>	2 PCS	2 PCS	2 PCS
 <p>Support Bar (deep)</p>	2 PCS	2 PCS	2 PCS
 <p>Support Bar (shallow)</p>	4 PCS	4 PCS	4 PCS

ASSEMBLY STEP

Installation of the Bracket

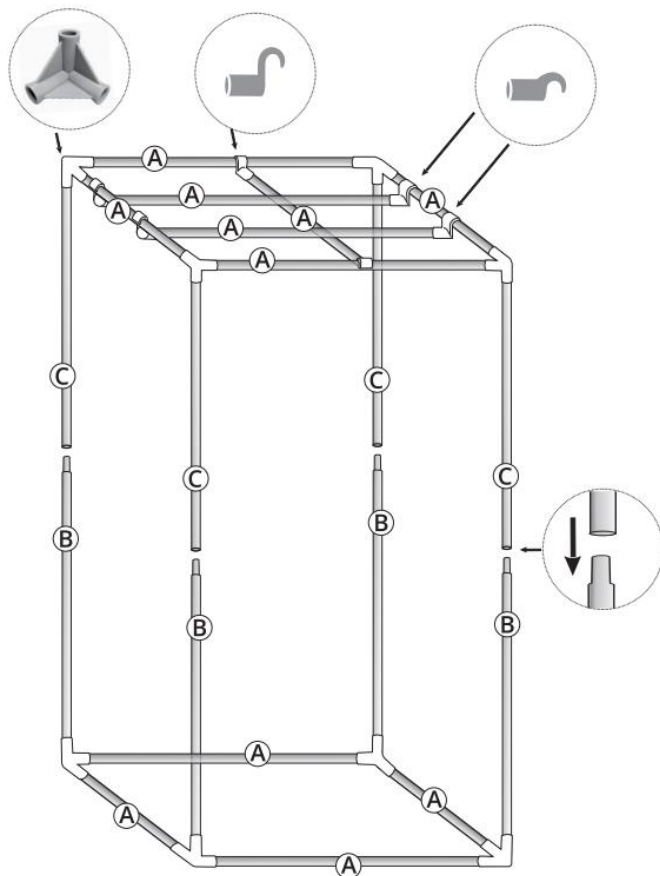

Installation of the Tent

STEP1

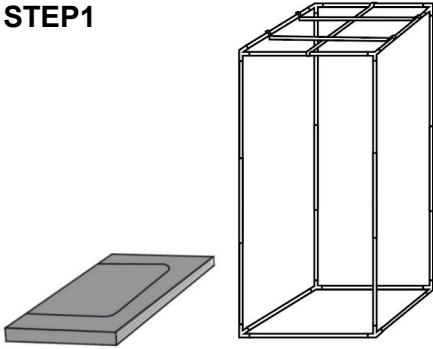

STEP2

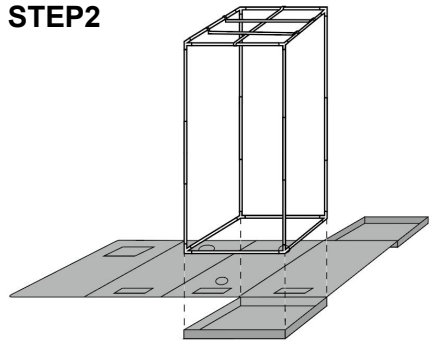

STEP3

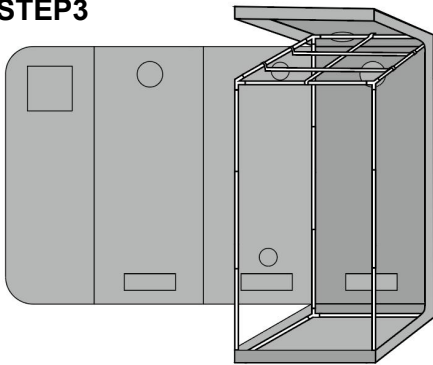

STEP4

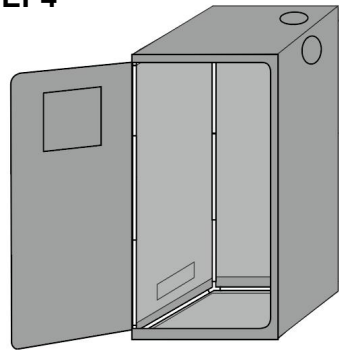

STEP5

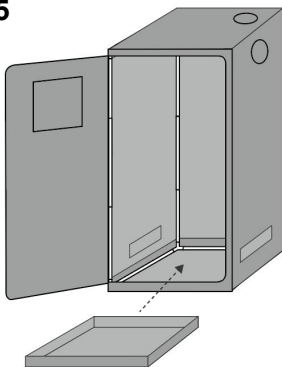

STEP6

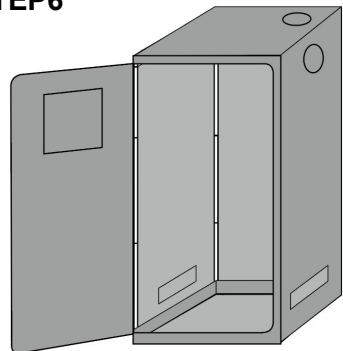



Incorrect operation



Correct operation

If light leakage occurs in a dark environment, smooth out the light barrier at the inner zipper of the tent to improve the light blocking effect.



Manufacturer: Shanghaimuxinmuyeyouxiangongsi

Address: Shuangchenglu 803nong11hao1602A-1609shi, baoshanqu, shanghai 200000 CN.

Imported to AUS: SIHAO PTY LTD. 1 ROKEVA STREETEASTWOOD NSW 2122 Australia

Imported to USA: Sanven Technology Ltd. Suite 250, 9166 Anaheim Place, Rancho Cucamonga, CA 91730

UK	REP
-----------	------------

YH CONSULTING LIMITED. C/O YH Consulting Limited Office 147, Centurion House, London Road, Staines-upon-Thames, Surrey, TW18 4AX

EC	REP
-----------	------------

E-CrossStu GmbH
Mainzer Landstr.69,
60329 Frankfurt am Main.



VEVOR

Affordable. Reliable. Home Improvement.

KIT DE TIENDA DE CULTIVO

MODELO: HX8080180 HX100100200 HX120120200

VEVOR

Affordable. Reliable. Home Improvement.

GROW TENT KIT

MODELO: HX8080180 HX100100200 HX120120200

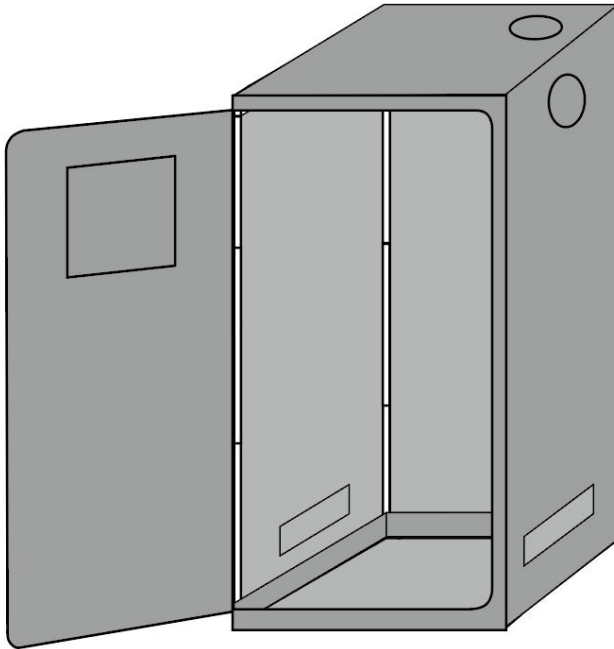

Estas son las instrucciones originales; lea atentamente todas las instrucciones del manual antes de utilizarlo. VEVOR se reserva el derecho de interpretar su manual de usuario. La apariencia del producto dependerá del producto que haya recibido. Le rogamos que nos disculpe si no le informamos de nuevo si hay actualizaciones tecnológicas o de software en nuestro producto.







PRODUCT INSTRUCTIONS

ADVERTENCIA:

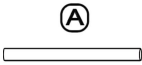
- Lea todas las instrucciones. Si la tienda de cultivo está... incorrectamente instalado y/o mantenido, existe potencial de daño o posible lesión o muerte.
- Tenga mucho cuidado al manipular objetos afilados en o Alrededor de la tienda.
- Mantenga los cables eléctricos lejos del equipo de forma segura. y áreas en y o alrededor de la tienda que pueda recoger agua.
- No cuelgue equipos sobre o desde una carpa de cultivo que esté por encima de la rango de peso soportado.
- No permita que los niños jueguen sobre, dentro o alrededor de tienda de cultivo.
- No utilice su tienda de cultivo si alguna parte de su tienda el material está agrietado, rasgado o roto.
- No coloque la tienda de cultivo cerca de una terraza, escaleras, sillas o otros inseguros estructura.
- Montar correctamente para evitar que la tienda se vuelque y causando lesiones.
- No exponga la tienda de cultivo a la luz solar directa, cerca de un llama abierta o una fuente de calor.
- Proporcione una circulación de aire adecuada en su tienda de cultivo para evitar que el aire se vuelva viciado.

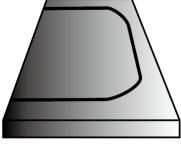
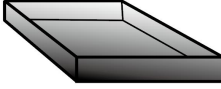
PARTS LIST

Código de producto	HX8080180	HX100100200	HX120120200
Tamaño	80X80X180 cm	100X100X200 cm	120X120X200 cm
Regiones			

 <p>(A)</p>	L 7,50 m X 11 piezas	L 9,50 m X 11 piezas	L1150 m m X 11 piezas
 <p>(B)</p>	Yo 910 mm X 4 PC	L 10 10 mm X 4 PC	Yo 1010 mm X 4 PC
 <p>(C)</p>	L 8 80 mm X 4 PC	L 9 80 mm X 4 PC	L 9 80 mm X 4 PC
 <p>Carpa</p>	1 pieza	1 pieza	1 pieza
 <p>Bandeja de suelo</p>	1 pieza	1 pieza	1 pieza
 <p>Adaptador de esquina</p>	8 piezas	8 piezas	8 piezas
 <p>Trampas de filtro S</p>	2 piezas	2 piezas	2 piezas
 <p>Barra de</p>	2 piezas	2 piezas	2 piezas

soporte (profundo)			
 Barra de soporte (superficial)	4 piezas	4 piezas	4 piezas

ASSEMBLY STEP

Instalación del soporte

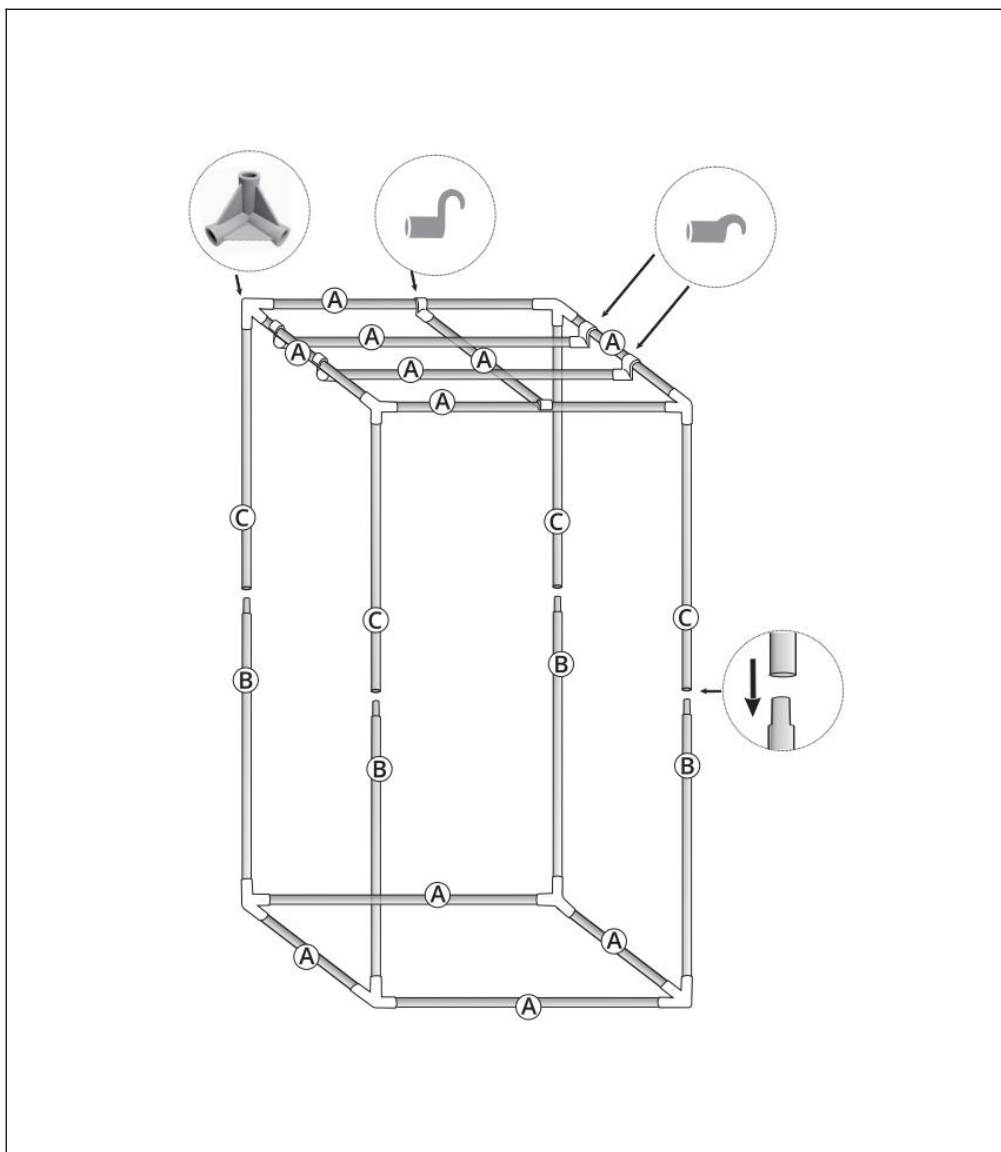

Instalación de la carpa

STEP1

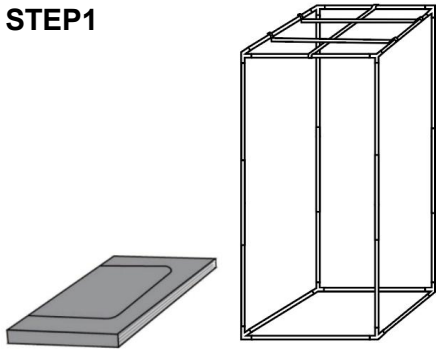

STEP2

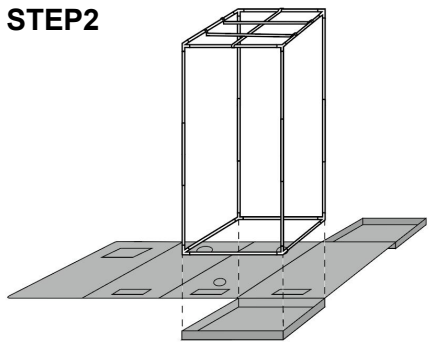

STEP3

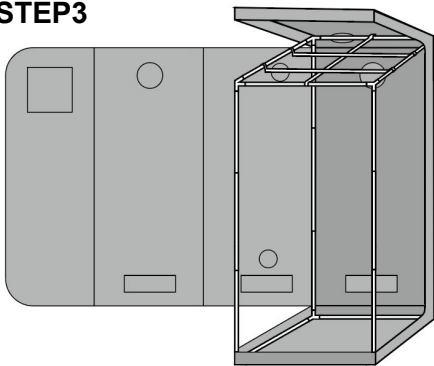

STEP4

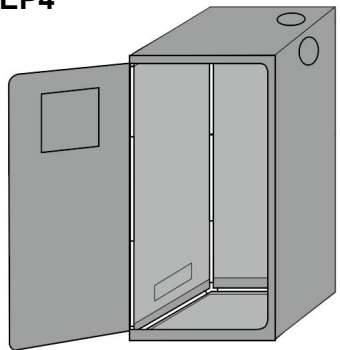

STEP5

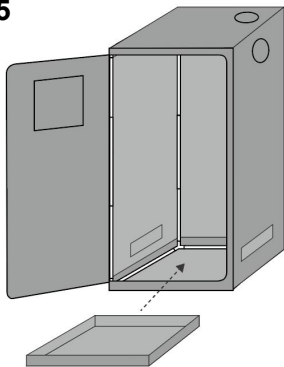

STEP6

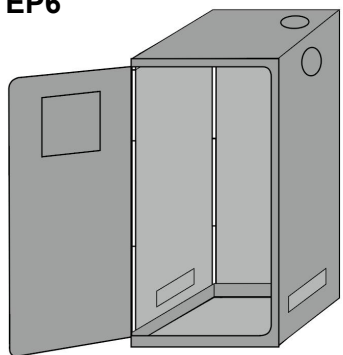



Incorrect operation



Correct operation

If light leakage occurs in a dark environment, smooth out the light barrier at the inner zipper of the tent to improve the light blocking effect.



Fabricante: Shanghaimuxinmuyeyouxiangongsi

Dirección: Shuangchenglu 803nong11hao1602A-1609shi, baoshanqu, Shanghái 200000 CN.

Importado a AUS: SIHAO PTY LTD. 1 ROKEVA STREET, EASTWOOD NSW 2122 Australia

Importado a EE. UU.: Sanven Technology Ltd. Suite 250, 9166 Anaheim Lugar, Rancho Cucamonga, CA 91730

UK	REP
-----------	------------

YH CONSULTING LIMITED. C/O YH Consulting Limited Office 147, Centurion House, London Road, Staines-upon-Thames, Surrey, TW18 4AX

EC	REP
-----------	------------

E-CrossStu GmbH
Mainzer Landstr.69,
60329 Frankfurt am Main.



VEVOR

Affordable. Reliable. Home Improvement.

ODLINGSTÄLTKIT

MODELL: HX8080180 HX100100200 HX120120200

VEVOR

Affordable. Reliable. Home Improvement.

GROW TENT KIT

MODELL: HX8080180 HX100100200 HX120120200

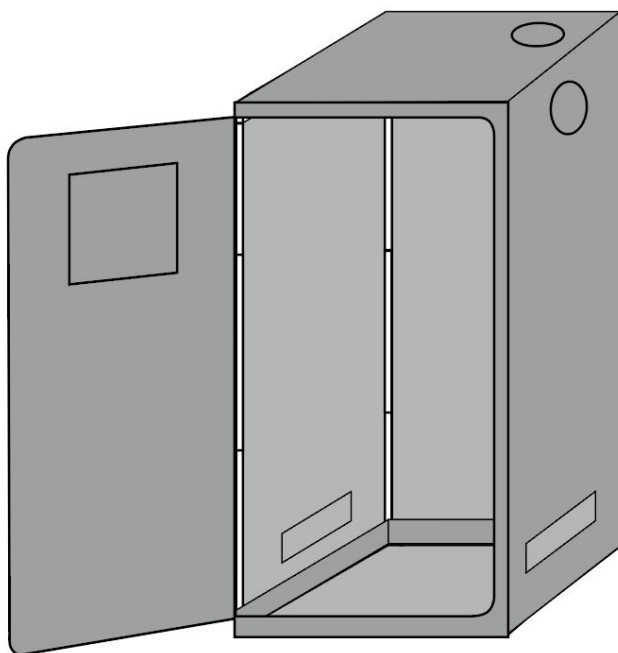

Detta är originalinstruktionerna, vänligen läs alla instruktioner noggrant innan du använder produkten. VEVOR förbehåller sig en tydlig tolkning av vår användarmanual. Produktens utseende ska vara beroende av den produkt du mottagit. Vi ber om ursäkt för att vi inte kommer att informera dig igen om det finns några teknik- eller programuppdateringar för vår produkt.



PRODUCT INSTRUCTIONS

VARNING:

- Läs igenom alla instruktioner. Om odlingstältet är otillbörligt installerat och/eller underhållet, finns det risk för skada eller eventuell personskada eller dödsfall.
- Var extremt försiktig vid hantering av vassa föremål i eller runt tältet.
- Håll elkablar säkert borta från utrustning och områden i och eller runt tältet som kan samla vatten.
- Häng inte utrustning på eller från odlingstält som är ovanför stödt viktintervall.
- Låt inte barn leka på, i eller runt odlingstält.
- Använd inte ditt odlingstält om någon del av ditt tält materialet är sprucket, sönderripen eller trasig.
- Placera inte odlingstältet nära en altan, trappa, stol eller andra osäkra strukturera.
- Montera tältet korrekt för att undvika att det välter. orsakar skada.
- Utsätt inte odlingstältet för direkt solljus, nära en öppen låga eller en värmekälla.
- Sörj för ordentlig luftcirkulation i ditt odlingstält för att förhindra att luften blir tråkig.

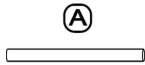
PARTS LIST

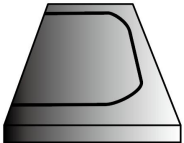
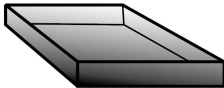
Produktkod	HX8080180	HX100100200	HX120120200
Delar	80X80X180 cm	100X100X200 cm	120X120X200 cm
	L 7,50 m X 11 st	L 9 50 mm X 11 ST	L1150 mm X 11 ST

 <p style="text-align: center;">(B)</p>	L 910 4 mm X 10 mm PCS	L 1010 4 mm X 10 mm PCS	L 1010 4 mm X 10 mm PCS
 <p style="text-align: center;">(C)</p>	L 880 4 mm X 10 mm PCS	L 980 4 mm X 10 mm PCS	L 980 4 mm X 10 mm PCS
 <p style="text-align: center;">Tält</p>	1 st	1 st	1 st
 <p style="text-align: center;">Golvbricka</p>	1 st	1 st	1 st
 <p style="text-align: center;">Hörnadapter</p>	8 st	8 st	8 st
 <p style="text-align: center;">Filter S - fällor</p>	2 st	2 st	2 st
 <p style="text-align: center;">Stödbar (djup)</p>	2 st	2 st	2 st
 <p style="text-align: center;">Stödstång (grund)</p>	4 st	4 st	4 st

ASSEMBLY STEP

Installation av fästet

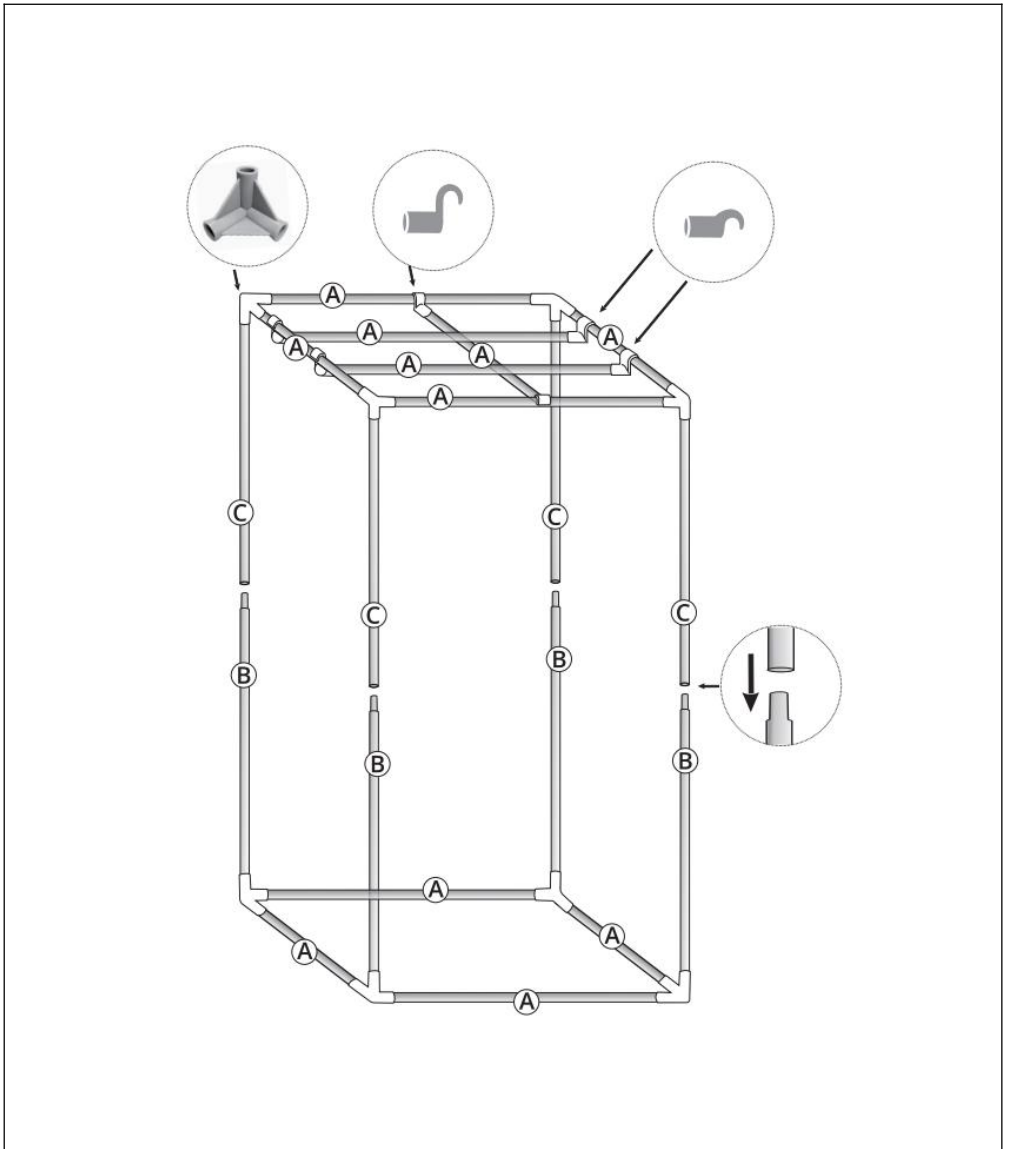

Installation av tältet

STEP1

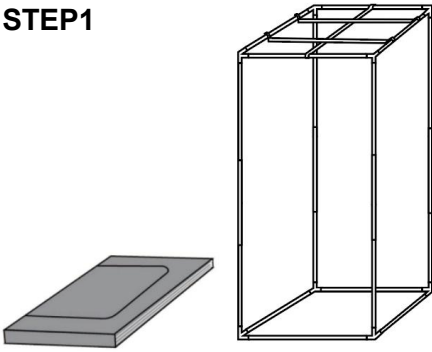

STEP2

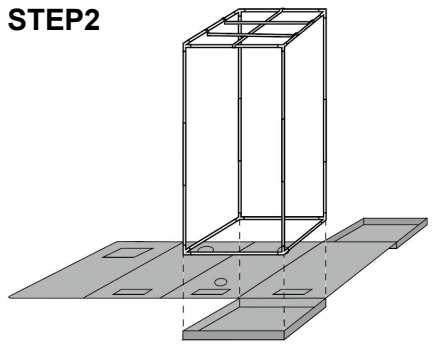

STEP3

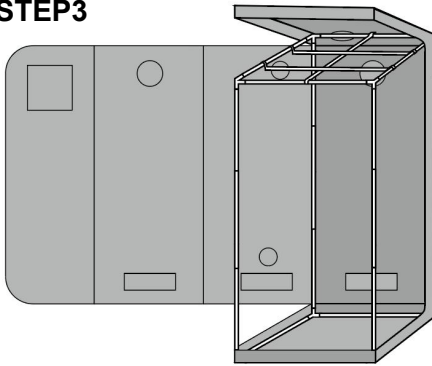

STEP4

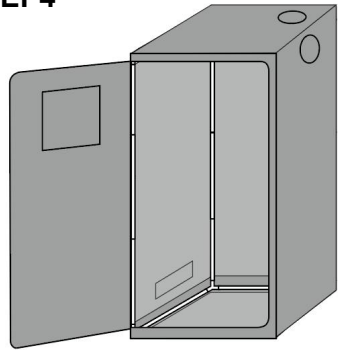

STEP5

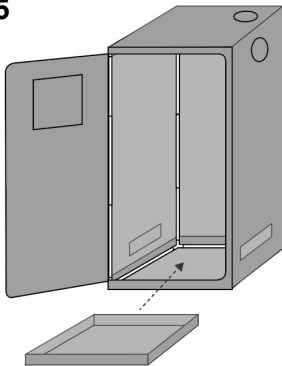

STEP6

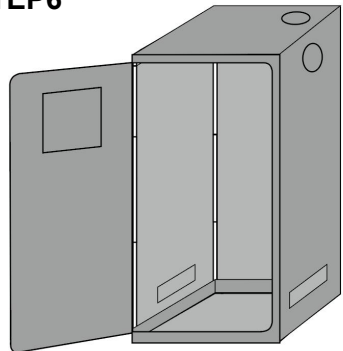



Incorrect operation



Correct operation

If light leakage occurs in a dark environment, smooth out the light barrier at the inner zipper of the tent to improve the light blocking effect.



Tillverkare: Shanghaimuxinmuyeyouxiangongsi

Adress: Shuangchenglu 803nong11hao1602A-1609shi, baoshanqu, Shanghai 200 000 kanadensiska republiken.

Importerad till Australien: SIHAO PTY LTD. 1 ROKEVA STREETEASTWOOD

NSW 2122 Australien

Importerad till USA: Sanven Technology Ltd. Suite 250, 9166 Anaheim Plats, Rancho Cucamonga, Kalifornien 91730

UK	REP
-----------	------------

YH CONSULTING LIMITED. C/O YH Consulting
Limited Office 147, Centurion House, London
Road, Staines-upon-Thames, Surrey, TW18 4AX

EC	REP
-----------	------------

E-CrossStu GmbH
Mainzer Landstr.69,
60329 Frankfurt am Main.

