

# VEVOR

**Affordable. Reliable. Home Improvement.**

**WEDDING ARCH BACKDROP STAND**

**MODEL: ABC-7.2ft+6ft+BU**



# VEVOR

Affordable. Reliable. Home Improvement.

WEDDING ARCH  
BACKDROP STAND

ABC-7.2ft+6ft+BU

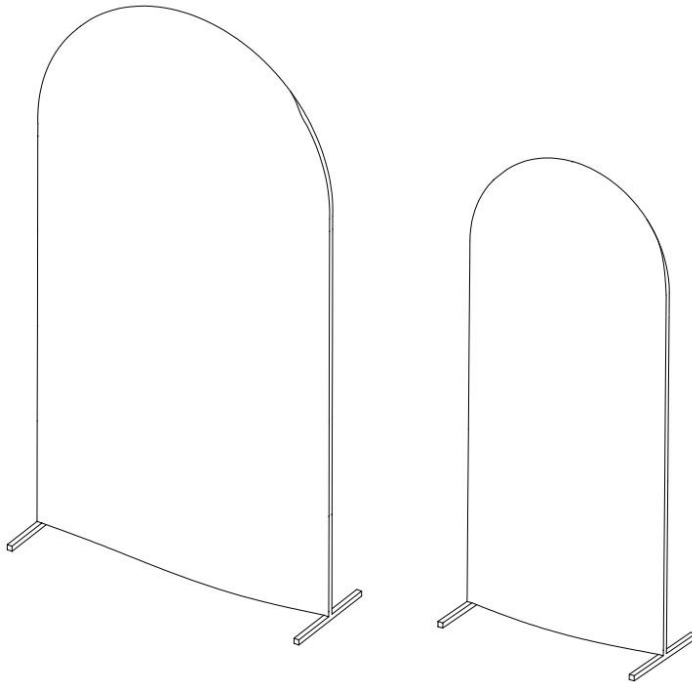

This is the original instruction, please read all manual instructions carefully before operating. VEVOR reserves a clear interpretation of our user manual. The appearance of the product shall be subject to the product you received. Please forgive us that we won't inform you again if there are any technology or software updates on our product.

## **INSTRUCTIONS**

Thank you very much for choosing this product. Please read all the instructions before using it. The information will help you achieve the best possible results.

PLEASE NOTE! Drawings in this manual are for illustration purposes only and in some details may differ from the actual product.

ATTENTION! Read all safety warnings and all instructions. The device or product used in the warning instructions is referred to wedding arch backdrop stand.

This product is not a toy or a toy chest. Do not allow children to play with this item.

Please place in a position that children cannot climb to avoid injury from falling from a height.

## **USAGE SAFETY**







1. Before installation, please make sure that the parts in the manual are in the packaging box. If you find parts missing, please contact your seller first.
2. Select an area for assembly that is clean and free of any debris that might cause persons working on the assembly to trip.
3. Preview the assembly instructions in your operator's manual before proceeding further.
4. After completing assembly, thoroughly inspect the machine to be sure that all nuts, bolts assemblies have been thoroughly tightened.
5. This product is not a climbing frame or hanging tool, and should not be used for purposes other than other than wedding arch backdrop stand.

## **SPECIFICATIONS**

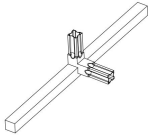



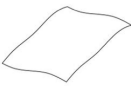

Model	ABC-7.2ft+6ft+BU
Color	gold
Product size	7.2*4ft, 6*2.6ft

# PARTS LIST

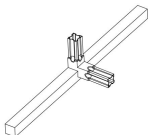
7.2ft

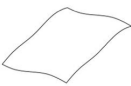

											
A	X2	B	X1	C	X10	D	X1	E	X1	F	X3
											
Cloth cover											
7.2ft	X1										

6ft



											
A	X2	B	X1	C	X9	D	X1	E	X1	F	X2
											
Cloth cover											
6ft	X1										

# PRODUCT ASSEMBLY

7.2ft

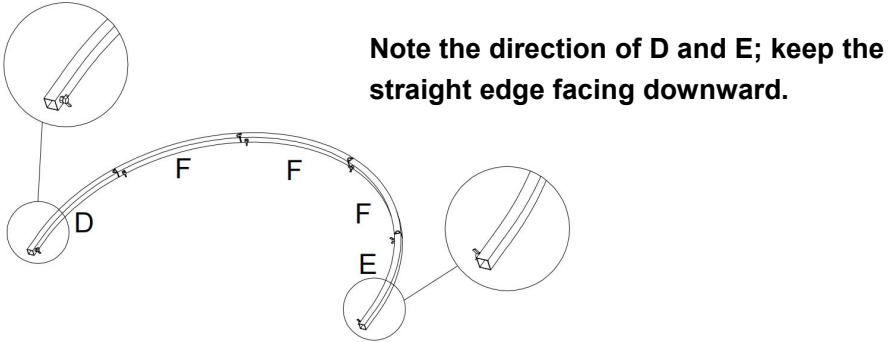
<b>STEP1</b>						
	D	X1	F	X3	E	X1



<b>STEP2</b>						
	A	X2	B	X1	C	X10

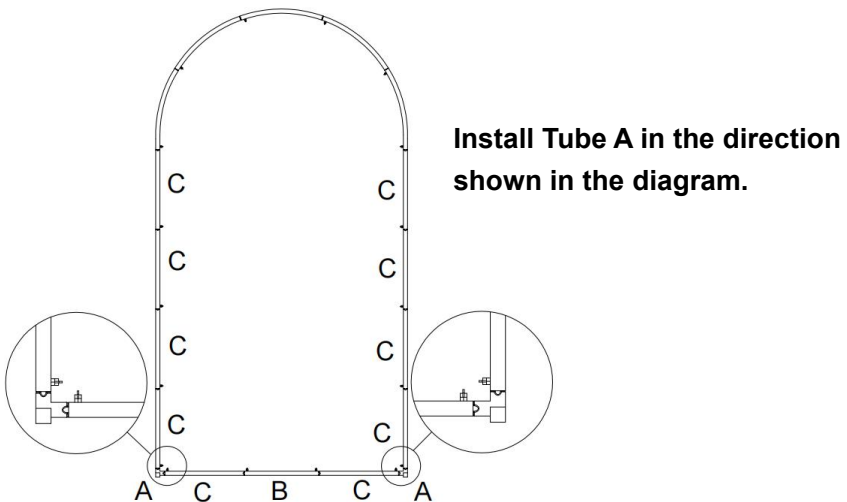

**STEP3**

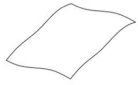

Cloth cover

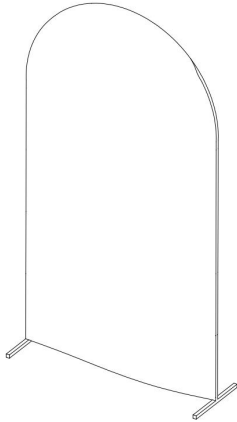

7.2ft

X1



Unfold the 7.2ft cloth cover and fit it into the background stand completed earlier.

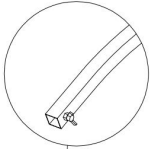

6ft

<b>STEP1</b>							
	D	X1	F	X2	E	X1	

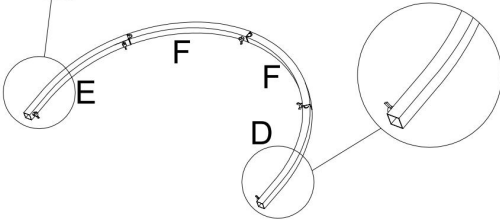

**Note the direction of D and E; keep the straight edge facing downward.**



<b>STEP2</b>							
	A	X2	B	X1	C	X9	

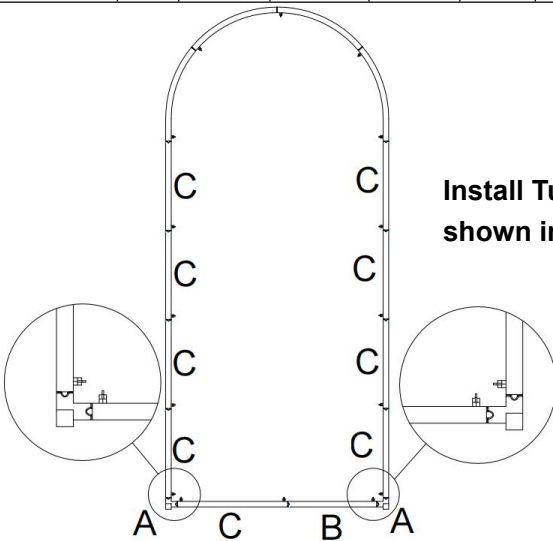

**Install Tube A in the direction shown in the diagram.**

**STEP3**

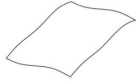

Cloth cover

6ft

X1

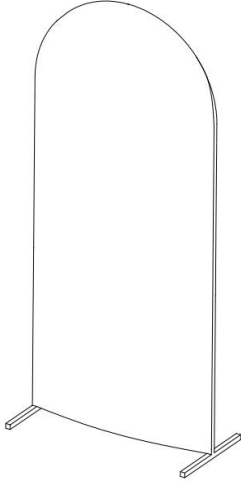

Unfold the 6ft cloth cover and fit it into the background stand completed earlier.

**Manufacturer:** Shanghaimuxinmuyeyouxiangongsi

**Address:** Shuangchenglu 803nong11hao1602A-1609shi, baoshanqu, shanghai 200000 CN.

**Imported to AUS:** SIHAO PTY LTD. 1 ROKEVA STREETEASTWOOD NSW 2122 Australia

**Imported to USA:** Sanven Technology Ltd. Suite 250, 9166 Anaheim Place, Rancho Cucamonga, CA 91730

<b>UK</b>	<b>REP</b>
-----------	------------

YH CONSULTING LIMITED. C/O YH Consulting Limited Office 147, Centurion House, London Road, Staines-upon-Thames, Surrey, TW18 4AX

<b>EC</b>	<b>REP</b>
-----------	------------

E-CrossStu GmbH  
Mainzer Landstr.69,  
60329 Frankfurt am Main.





# VEVOR

**Affordable. Reliable. Home Improvement.**

**SOPORTE DE FONDO DE ARCO DE BODA**

**MODELO: ABC-7.2 pies + 6 pies + BU**



# VEVOR

Affordable. Reliable. Home Improvement.

WEDDING ARCH  
BACKDROP STAND

ABC-7,2 pies + 6 pies + BU

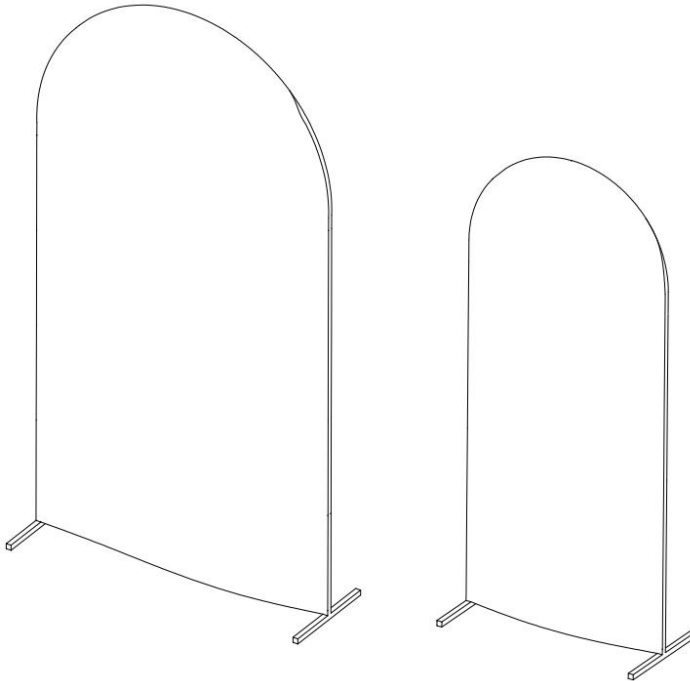

Estas son las instrucciones originales; lea atentamente todas las instrucciones del manual antes de utilizarlo. VEVOR se reserva el derecho de interpretar este manual de usuario. La apariencia del producto dependerá del producto que haya recibido. Le rogamos que nos disculpe si no le informamos de nuevo si hay actualizaciones tecnológicas o de software en nuestro producto.

## INSTRUCCIONES

Muchas gracias por elegir este producto. Lea todas las instrucciones antes de usarlo. Esta información le ayudará a obtener los mejores resultados posibles. ¡ATENCIÓN! Los dibujos de este manual son solo ilustrativos y algunos detalles pueden diferir del producto real.

¡ATENCIÓN! Lea todas las advertencias de seguridad e instrucciones. El dispositivo o producto utilizado en las advertencias se refiere al arco de boda. pararse .

Este producto no es un juguete ni un baúl de juguetes. No permita que los niños jueguen con él. Colóquelo en un lugar donde los niños no puedan trepar para evitar lesiones por caídas.

## SEGURIDAD DE USO







1. Antes de la instalación, asegúrese de que las piezas del manual estén en la caja. Si falta alguna pieza, contacte primero con el vendedor.
2. Seleccione un área para el montaje que esté limpia y libre de residuos que puedan hacer tropezar a las personas que trabajan en el montaje.
3. Consulte las instrucciones de montaje en el manual del operador antes de continuar.
4. Después de completar el montaje, inspeccione minuciosamente la máquina para asegurarse de que todos los conjuntos de tuercas y pernos estén completamente apretados.
5. Este producto no es un marco de escalada ni una herramienta para colgarse y no debe ser utilizado para fines distintos a los del soporte de fondo del arco de la boda.

## PRESUPUESTO

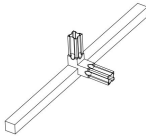





Modelo	ABC-7,2 pies + 6 pies + BU
Color	oro
Tamaño del producto	7,2 x 4 pies , 6 x 2,6 pies

## LISTA DE PIEZAS

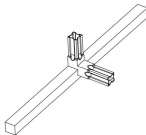
7,2 pies

											
A	X2	B	X1	do	X10	D	X1	mi	X1	F	X3
											
Funda de tela											
7,2 pies	X1										



6 pies

											
A	X2	B	X1	do	X9	D	X1	mi	X1	F	X2

	
<p>Funda de tela</p>	
<p>6 pies</p>	<p>X1</p>

## MONTAJE DEL PRODUCTO



7,2 pies

<b>PASO</b> <b>1</b>						
	D	X1	F	X3	mi	X1

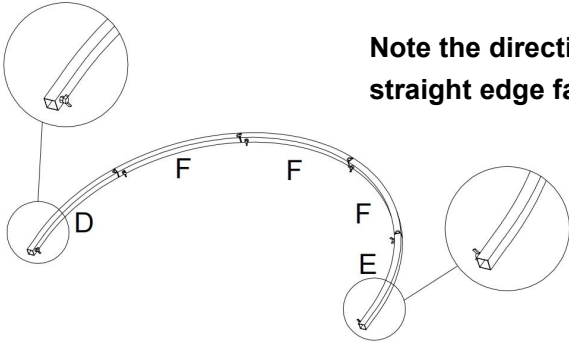

**Note the direction of D and E; keep the straight edge facing downward.**

<b>PASO 2</b>						
	A	X2	B	X1	do	X10

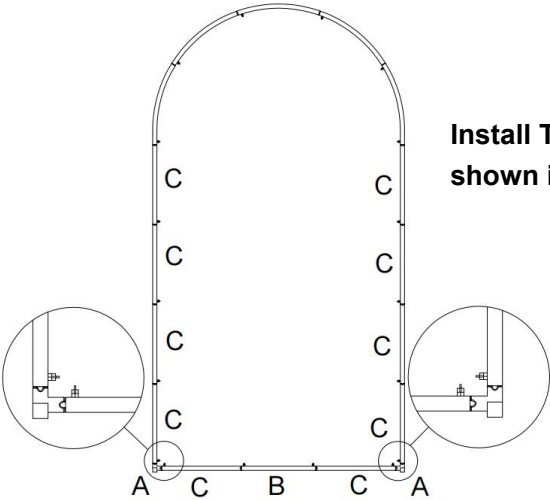

**Install Tube A in the direction shown in the diagram.**

**PASO  
3**

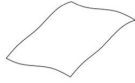

Funda de  
tela

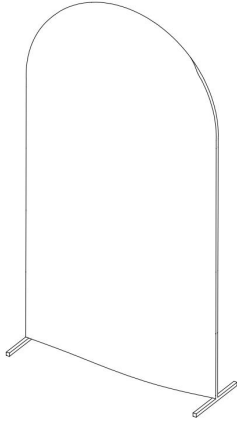

7,2  
pies

X1





Unfold the 7.2ft cloth cover and fit it into the background stand completed earlier.

6 pies

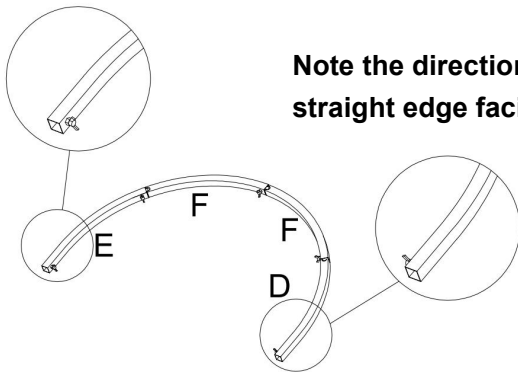
<b>PASO</b> <b>1</b>						
	D	x1	F	x2	mi	x1



**Note the direction of D and E; keep the straight edge facing downward.**

<b>PASO 2</b>							
	A	x2	B	x1	do	x9	

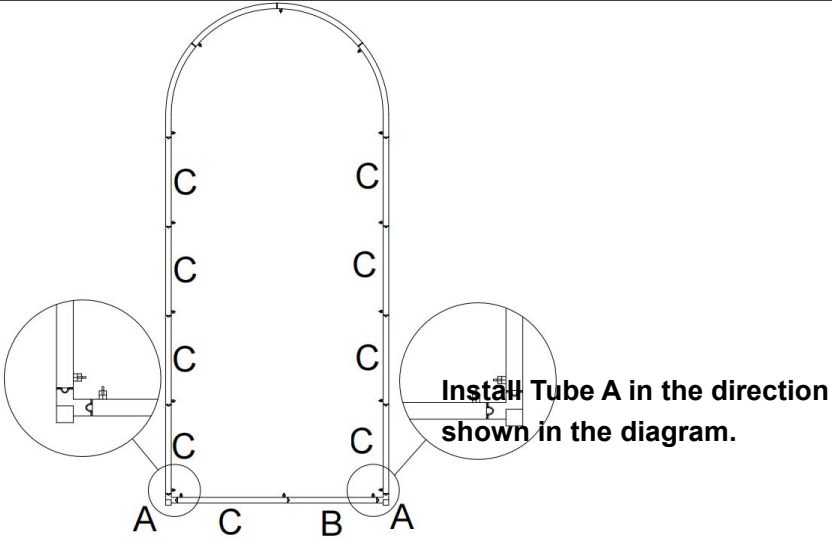

**PASO  
3**

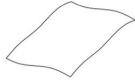

Funda de  
tela

6  
pies

X1

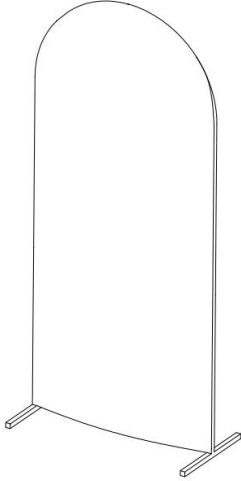

Unfold the 6ft cloth cover and fit it into the background stand completed earlier.

**Fabricante:** Shanghaimuxinmuyeyouxiangongsi

**Dirección:** Shuangchenglu 803nong11hao1602A-1609shi, baoshanqu, Shanghai 200000 CN.

**Importado a AUS:** SIHAO PTY LTD. 1 ROKEVA STREET EASTWOOD NSW 2122 Australia

**Importado a EE. UU.:** Sanven Technology Ltd. Suite 250, 9166 Anaheim Lugar, Rancho Cucamonga, CA 91730

<b>UK</b>	<b>REP</b>
-----------	------------

YH CONSULTING LIMITED. C/O YH Consulting Limited Office 147, Centurion House, London Road, Staines-upon-Thames, Surrey, TW18 4AX

<b>EC</b>	<b>REP</b>
-----------	------------

E-CrossStu GmbH  
Mainzer Landstr.69,  
60329 Frankfurt am Main.





# VEVOR

**Affordable. Reliable. Home Improvement.**

**BRÖLLOPSBÅGENS BAKGRUNDSSTATIV**

**MODELL: ABC-7,2 fot + 6 fot + BU**



# VEVOR

Affordable. Reliable. Home Improvement.

WEDDING ARCH  
BACKDROP STAND

ABC-2,1 m + 1,8 m + BU

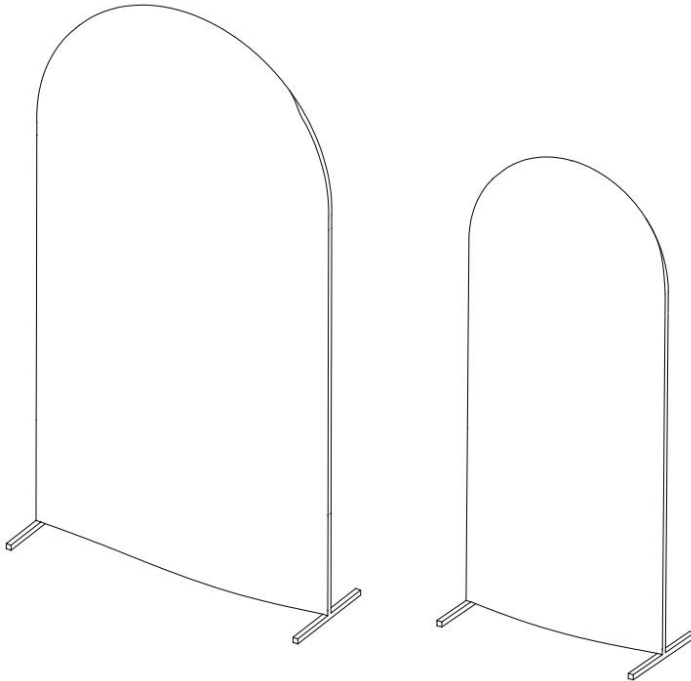

Detta är originalinstruktionerna, vänligen läs alla instruktioner noggrant innan du använder produkten. VEVOR förbehåller sig en tydlig tolkning av vår användarmanual. Produktens utseende ska vara beroende av den produkt du mottagit. Vi ber om ursäkt för att vi inte kommer att informera dig igen om det finns några teknik- eller programuppdateringar för vår produkt.

## INSTRUKTIONER

Tack så mycket för att du valde den här produkten. Läs alla instruktioner innan du använder den. Informationen hjälper dig att uppnå bästa möjliga resultat.

**OBSERVERA!** Ritningarna i denna manual är endast avsedda som illustration och kan skilja sig från den faktiska produkten i vissa detaljer.

**OBS!** Läs alla säkerhetsvarningar och alla instruktioner. Enheten eller produkten som används i varningsinstruktionerna avser en bakgrundsbild av en båge . stå . Denna produkt är inte en leksak eller leksakslåda. Låt inte barn leka med produkten. Placera den på en plats där barn inte kan klättra för att undvika skador från fall från höjd.

## ANVÄNDNINGSSÄKERHET







1. Innan installationen, se till att delarna i manualen finns i förpackningen. Om du upptäcker att delar saknas, vänligen kontakta din säljare först.
2. Välj ett område för montering som är rent och fritt från skräp som kan orsaka snubbelskador för personer som arbetar med monteringen.
3. Förhandsgranska monteringsanvisningarna i din bruksanvisning innan du fortsätter .
4. Efter monteringen, inspektera maskinen noggrant för att säkerställa att alla muttrar och bultar har åtdragits ordentligt.
5. Denna produkt är inte en klätterställning eller ett upphängningsverktyg och bör inte användas för andra ändamål än bakgrundsstativ för bröllopsbåge.

## SPECIFIKATIONER

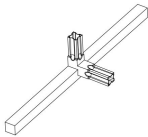





Modell	ABC-2,1 m + 1,8 m + BU
Färg	g gammal
Produktstorlek	7,2*4 fot , 6*2,6 fot

## DELLISTA

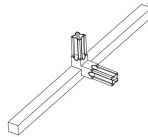
7,2 fot



											
En	X2	B	X1	C	X10	D	X1	E	X1	F	X3
											
Tygöverdrag											
7,2 fot	X1										

1,8 meter

											
En	X2	B	X1	C	X9	D	X1	E	X1	F	X2
											
Tygöverdrag											
1,8 meter	X1										

# PRODUKTMONTERING

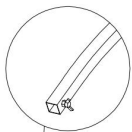

7,2 fot

<b>STEG1</b>							
	D	X1	F	X3	E	X1	

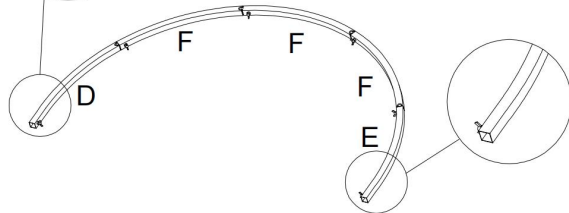

**Note the direction of D and E; keep the straight edge facing downward.**



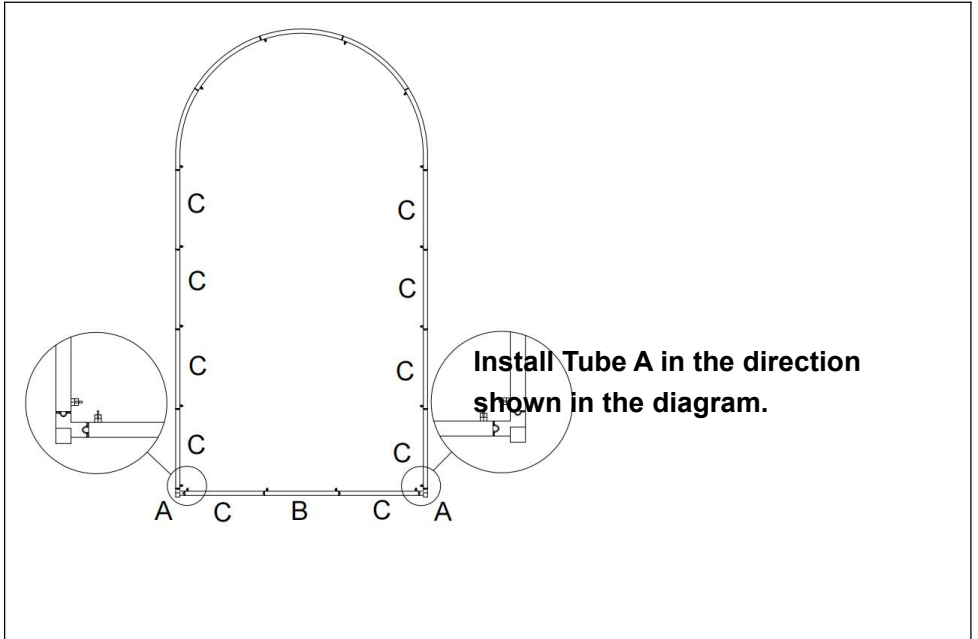

<b>STEG2</b>							
	E n	X2	B	X1	C	X10	

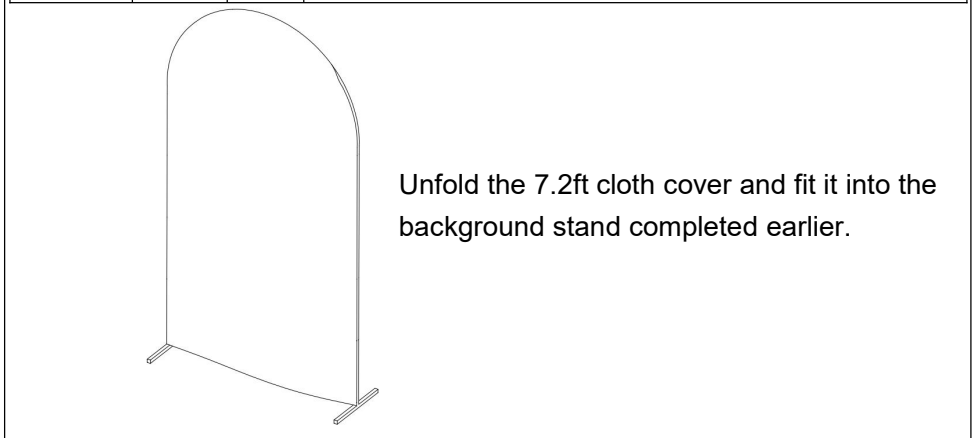

<b>STEG3</b>	 Tygöverdra g	
	7,2 fot	X1



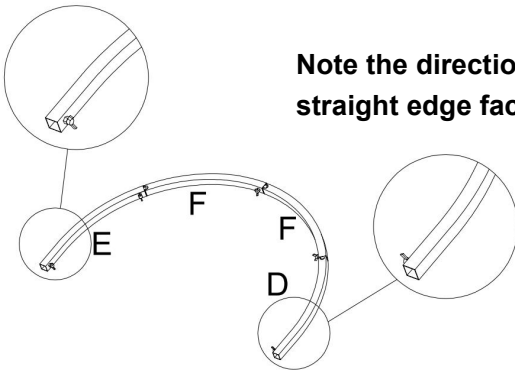

1,8 meter

<b>STEG1</b>							
	D	X1	F	X2	E	X1	



**Note the direction of D and E; keep the straight edge facing downward.**

<b>STEP2</b>						
	<b>E</b> <b>n</b>	X2	<b>B</b>	X1	<b>C</b>	X9

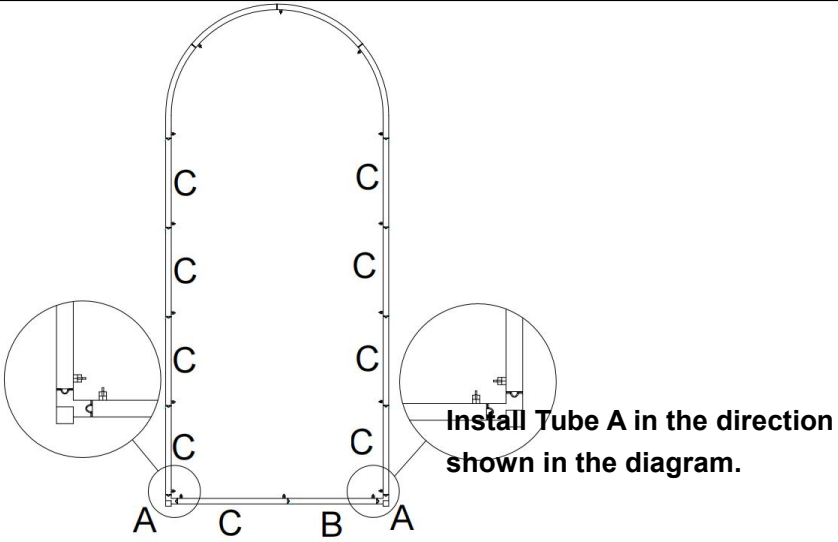

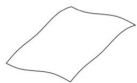
**STEG3**Tygöverdra  
g1,8  
mete  
r

X1

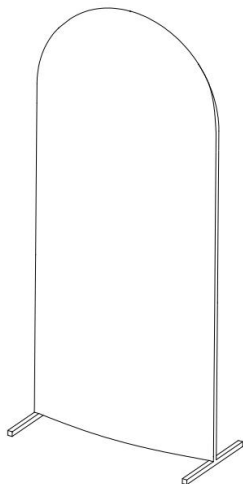

Unfold the 6ft cloth cover and fit it into the background stand completed earlier.

**Tillverkare:** Shanghaimuxinmuyeyouxiangongsi

**Adress:** Shuangchenglu 803nong11hao1602A-1609shi, baoshanqu, Shanghai 200 000 kanadensiska republiken.

**Importerad till Australien:** SIHAO PTY LTD. 1 ROKEVA

STREETEASTWOOD

NSW 2122 Australien

**Importerad till USA:** Sanven Technology Ltd. Suite 250, 9166 Anaheim

Plats, Rancho Cucamonga, Kalifornien 91730

<b>UK</b>	<b>REP</b>
-----------	------------

YH CONSULTING LIMITED. C/O YH Consulting

Limited Office 147, Centurion House, London

Road, Staines-upon-Thames, Surrey, TW18 4AX

<b>EC</b>	<b>REP</b>
-----------	------------

E-CrossStu GmbH

Mainzer Landstr.69,

60329 Frankfurt am Main.







# VEVOR

**Affordable. Reliable. Home Improvement.**

**BRUILOFTSBOOG ACHTERGRONDSTANDAARD**

**MODEL: ABC-7,2ft+6ft+BU**



# VEVOR

Affordable. Reliable. Home Improvement.

WEDDING ARCH  
BACKDROP STAND

ABC-7,2ft+6ft+BU

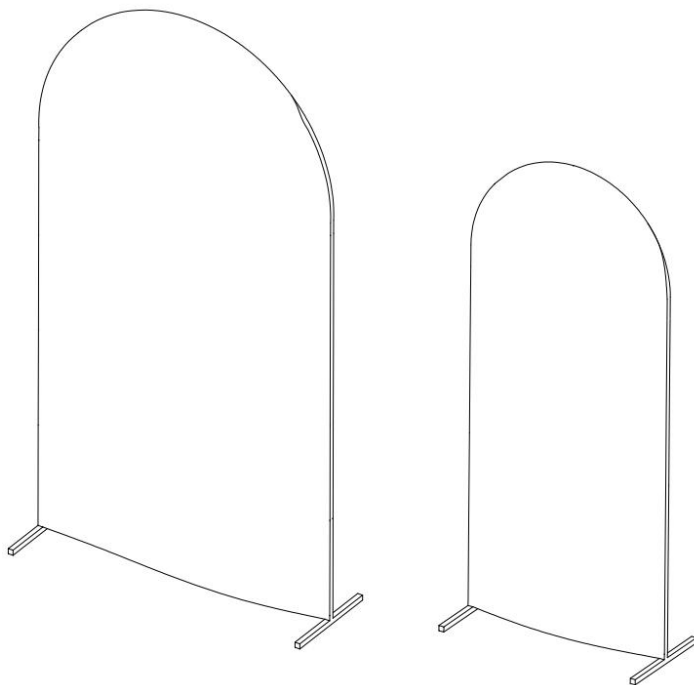

Dit is de originele handleiding. Lees alle instructies zorgvuldig door voordat u het product gebruikt. VEVOR behoudt zich het recht voor om de gebruiksaanwijzing duidelijk te interpreteren. Het uiterlijk van het product is afhankelijk van het product dat u hebt ontvangen. Neemt u het ons niet kwalijk dat we u niet meer op de hoogte stellen van eventuele technologische of software-updates voor ons product.

## INSTRUCTIES

Hartelijk dank dat u voor dit product hebt gekozen. Lees de gebruiksaanwijzing aandachtig door voordat u het gebruikt. Deze informatie helpt u de best mogelijke resultaten te behalen.

LET OP! De tekeningen in deze handleiding dienen slechts ter illustratie en kunnen op sommige details afwijken van het daadwerkelijke product.

LET OP! Lees alle veiligheidswaarschuwingen en alle instructies. Het apparaat of product dat in de waarschuwingsinstructies wordt gebruikt, wordt aangeduid als 'wedding arch back drop'. stelling .

Dit product is geen speelgoed of speelgoedkist. Laat kinderen er niet mee spelen. Plaats het op een plek waar kinderen niet kunnen klimmen om letsel door een val van hoogte te voorkomen.

## GEbruiksVEILIGHEID







1. Controleer vóór de installatie of de onderdelen uit de handleiding in de verpakking zitten. Als er onderdelen ontbreken, neem dan eerst contact op met uw verkoper.
2. Kies een plek voor de montage die schoon is en vrij van vuil waar personen die aan de montage werken over kunnen struikelen.
3. Bekijk de montage-instructies in de handleiding voordat u verdergaat.
4. Controleer de machine grondig nadat de montage is voltooid, om er zeker van te zijn dat alle moeren en bouten goed zijn vastgedraaid.
5. Dit product is geen klimrek of ophanghulpmiddel en mag niet worden gebruikt als ophanghulpmiddel. worden gebruikt voor andere doeleinden dan als achtergrondstandaard voor een trouwboog.

## SPECIFICATIES

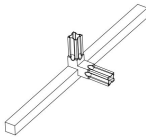





Model	ABC-7,2ft+6ft+BU
Kleur	goud
Productgrootte	7,2*4ft , 6*2,6ft

## ONDERDELENLIJST

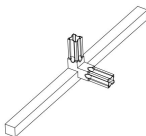
7,2 voet

											
A	X2	B	X1	C	X10	D	X1	E	X1	F	X3
											
Stoffen hoes											
7,2 voet	X1										

6 voet

											
A	X2	B	X1	C	X9	D	X1	E	X1	F	X2
											
Stoffen hoes											

6 voet	X1
-----------	----

## PRODUCTASSEMBLAGE

7,2 voet

<b>STAP</b> <b>1</b>						
	D	X1	F	X3	E	X1

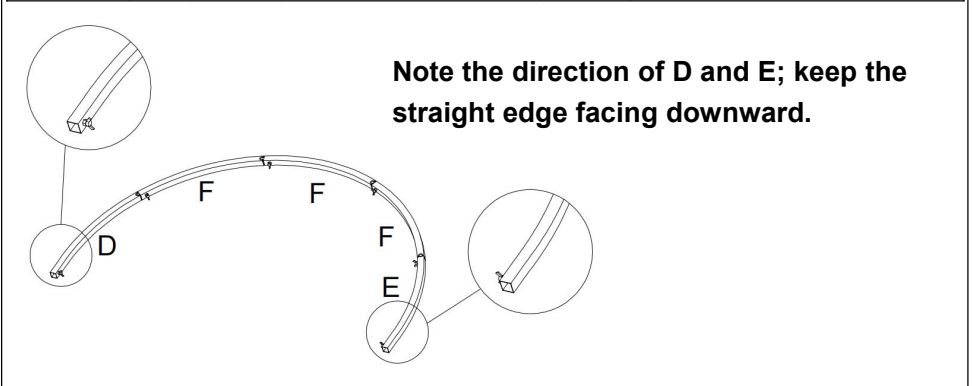



**STAP  
3**

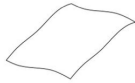

Stoffen  
hoes

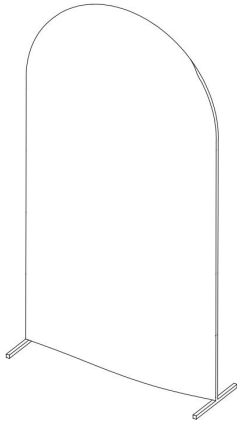

7,2  
voet

X1





Unfold the 7.2ft cloth cover and fit it into the background stand completed earlier.

6 voet

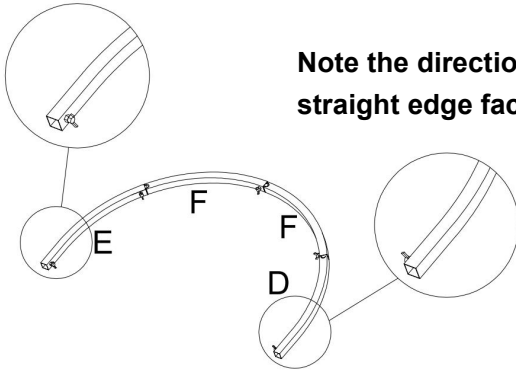
<b>STAP 1</b>							
	D	X1	F	X2	E	X1	



**Note the direction of D and E; keep the straight edge facing downward.**

<b>STAP 2</b>							
	A	X2	B	X1	C	X9	

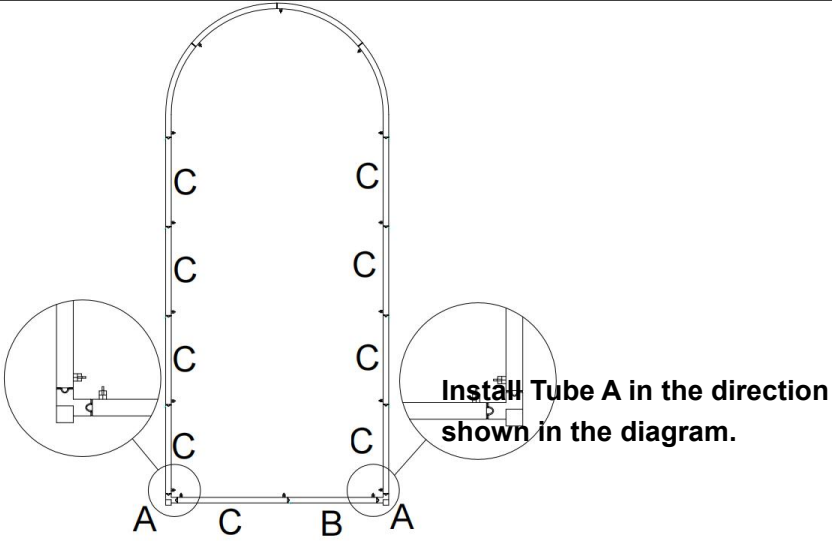

<b>STAP 3</b>	 Stoffen hoes	
	6 voet	X1

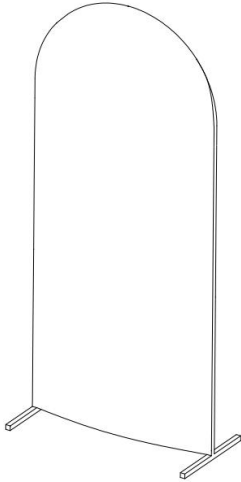

Unfold the 6ft cloth cover and fit it into the background stand completed earlier.

**Fabrikant:** Shanghaimuxinmuyeyouxiangongsi

**Adres:** Shuangchenglu 803nong11hao1602A-1609shi, baoshanqu, shanghai 200000 CN.

**Geïmporteerd naar AUS:** SIHAO PTY LTD. 1 ROKEVA

STREETEASTWOOD

NSW 2122 Australië

**Geïmporteerd naar de VS:** Sanven Technology Ltd. Suite 250, 9166

Anaheim

Plaats, Rancho Cucamonga, CA 91730

<b>UK</b>	<b>REP</b>
-----------	------------

YH CONSULTING LIMITED. C/O YH Consulting

Limited Office 147, Centurion House, London

Road, Staines-upon-Thames, Surrey, TW18 4AX

<b>EC</b>	<b>REP</b>
-----------	------------

E-CrossStu GmbH

Mainzer Landstr.69,

60329 Frankfurt am Main.







# VEVOR

**Affordable. Reliable. Home Improvement.**

**SUPPORT DE TOILE DE FOND POUR ARCHE DE**

**MARIAGE**

**MODÈLE : ABC-7,2 pi + 6 pi + BU**



# VEVOR

Affordable. Reliable. Home Improvement.

WEDDING ARCH  
BACKDROP STAND

ABC-7,2 pieds + 6 pieds + BU

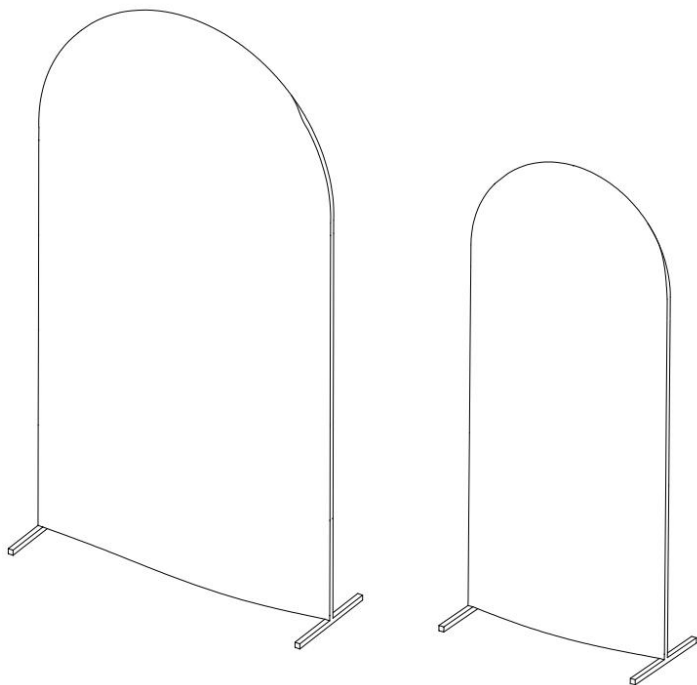

Ceci est le mode d'emploi d'origine. Veuillez lire attentivement l'intégralité du manuel avant utilisation. VEVOR se réserve le droit d'interpréter clairement ce manuel d'utilisation. L'apparence du produit dépend du produit que vous avez reçu. Veuillez nous excuser de ne pas vous informer ultérieurement des mises à jour technologiques ou logicielles de notre produit.

## INSTRUCTIONS

Merci d'avoir choisi ce produit. Veuillez lire attentivement les instructions avant utilisation. Ces informations vous aideront à obtenir les meilleurs résultats possibles.

ATTENTION ! Les dessins de ce manuel sont fournis à titre d'illustration uniquement et peuvent différer du produit réel sur certains points.

ATTENTION ! Veuillez lire attentivement tous les avertissements de sécurité et toutes les instructions. L'appareil ou le produit utilisé dans les instructions d'avertissement fait référence à l' arche de mariage . rester .

Ce produit n'est ni un jouet ni un coffre à jouets. Ne laissez pas les enfants jouer avec. Veuillez le placer à un endroit inaccessible aux enfants pour éviter les blessures en cas de chute.

## SÉCURITÉ D'UTILISATION







1. Avant l'installation, veuillez vous assurer que les pièces du manuel se trouvent dans l'emballage. Si des pièces manquent, veuillez d'abord contacter votre vendeur.
2. Choisissez une zone d'assemblage propre et exempte de tout débris susceptible de faire trébucher les personnes travaillant sur l'assemblage.
3. Consultez les instructions d'assemblage dans votre manuel d'utilisation avant de continuer.
4. Une fois l'assemblage terminé, inspectez soigneusement la machine pour vous assurer que tous les écrous et boulons ont été bien serrés.
5. Ce produit n'est pas un cadre d'escalade ni un outil de suspension et ne doit pas être utilisé à des fins autres que le support de toile de fond d'arche de mariage.

## CARACTÉRISTIQUES

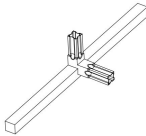





Modèle	ABC-7,2 pieds + 6 pieds + BU
Couleur	or
Taille du produit	7,2*4 pieds , 6*2,6 pieds

## LISTE DES PIÈCES

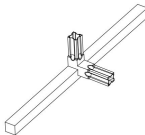
7,2 pieds

											
UN	X2	B	X1	C	X10	D	X1	E	X1	F	X3
											
Couverture en tissu											
7,2 pieds	X1										



6 pieds

											
UN	X2	B	X1	C	X9	D	X1	E	X1	F	X2



 <p>Couverture en tissu</p>	
6 pieds	X1

## ASSEMBLAGE DU PRODUIT

7,2 pieds

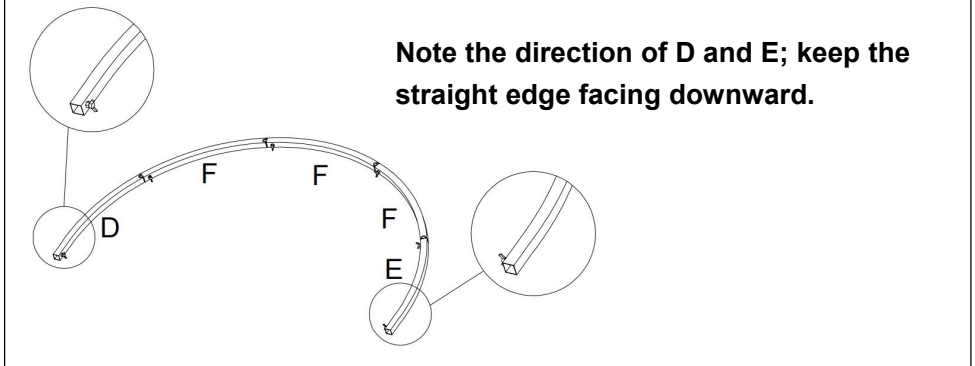
ÉTAPE 1					
	D	X1	F	X3	E



<b>ÉTAPE 2</b>							
	<b>U N</b>	X2	<b>B</b>	X1	<b>C</b>	X10	

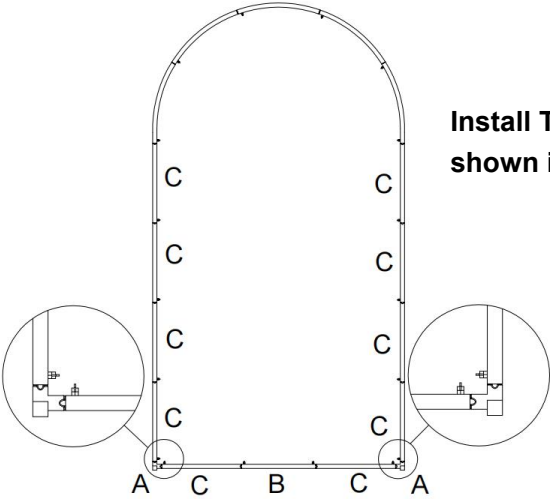

**Install Tube A in the direction shown in the diagram.**

**ÉTAPE  
3**

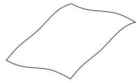

Couverture  
en tissu

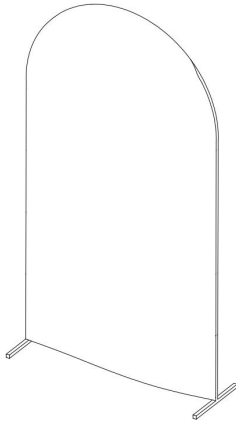

7,2  
pieds

X1



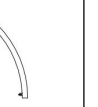

Unfold the 7.2ft cloth cover and fit it into the background stand completed earlier.

# 6 pieds

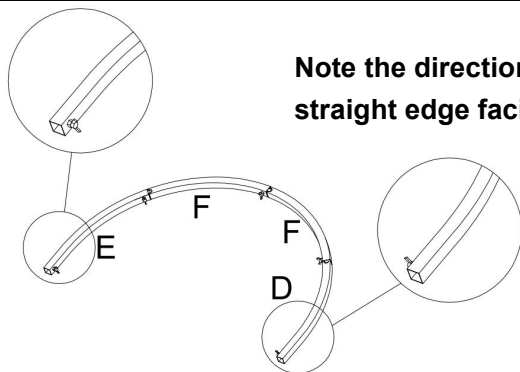
ÉTAPE 1							
	D	X1	F	X2	E	X1	



ÉTAPE 2							
	U N	X2	B	X1	C	X9	

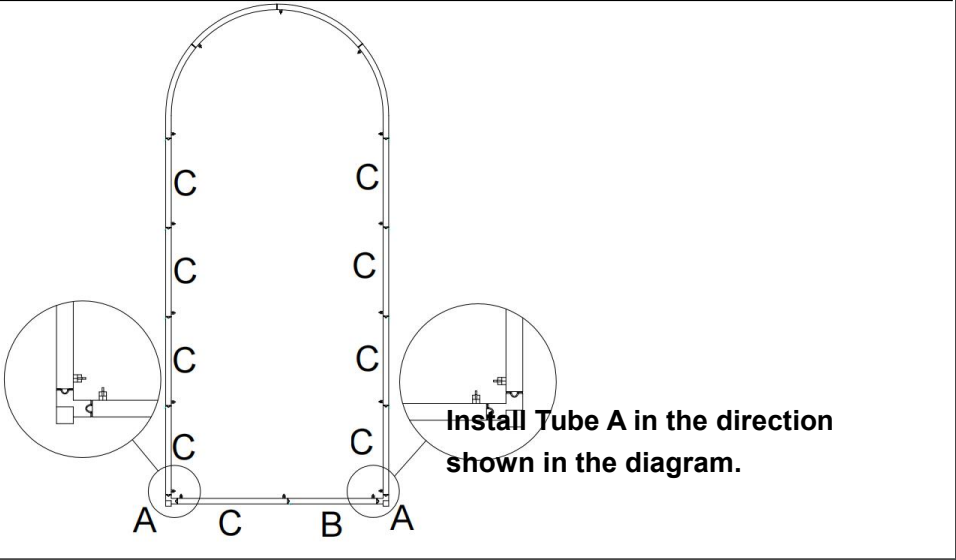

**ÉTAPE  
3**

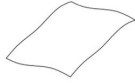

Couverture  
en tissu

6  
pieds

X1

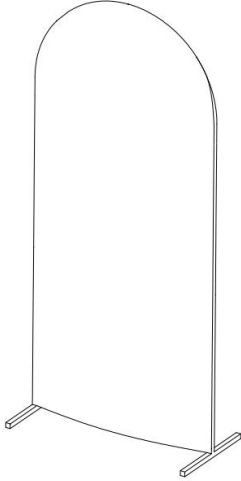

Unfold the 6ft cloth cover and fit it into the background stand completed earlier.

**Fabricant** : Shanghaimuxinmuyeyouxiangongsi

**Adresse** : Shuangchenglu 803nong11hao1602A-1609shi, baoshanqu, Shanghai 200 000 CN.

**Importé en Australie** : SIHAO PTY LTD. 1 ROKEVA STREET, ASTWOOD NSW 2122 Australie

**Importé aux États-Unis** : Sanven Technology Ltd. Suite 250, 9166 Anaheim

Lieu, Rancho Cucamonga, CA 91730

<b>UK</b>	<b>REP</b>
-----------	------------

YH CONSULTING LIMITED. C/O YH Consulting Limited Office 147, Centurion House, London Road, Staines-upon-Thames, Surrey, TW18 4AX

<b>EC</b>	<b>REP</b>
-----------	------------

E-CrossStu GmbH  
Mainzer Landstr.69,  
60329 Frankfurt am Main.







# VEVOR

**Affordable. Reliable. Home Improvement.**

**HOCHZEITSBOGEN-HINTERGRUNDSTÄNDER**

**MODELL: ABC-7,2 Fuß + 6 Fuß + BU**



# VEVOR

Affordable. Reliable. Home Improvement.

WEDDING ARCH  
BACKDROP STAND

ABC-7,2 Fuß + 6 Fuß + BU

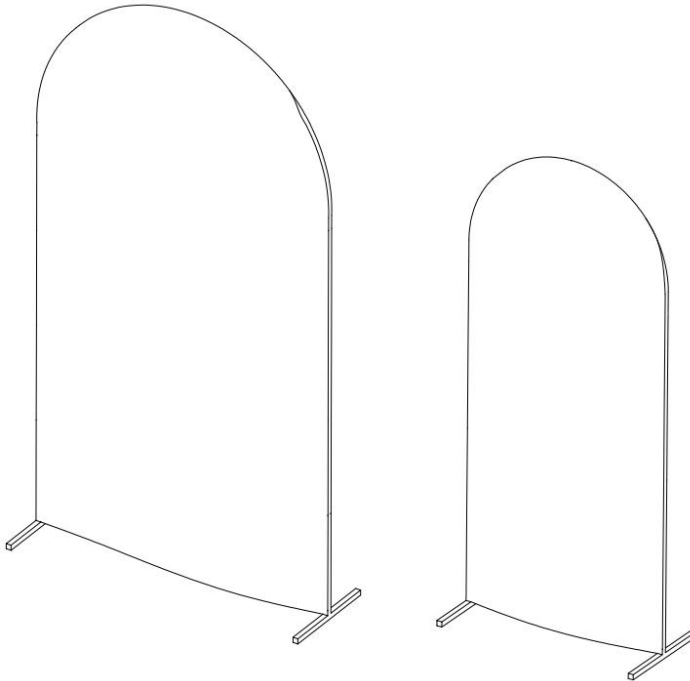

Dies ist die Originalanleitung. Bitte lesen Sie alle Anweisungen sorgfältig durch, bevor Sie das Gerät in Betrieb nehmen. VEVOR behält sich eine klare Auslegung unserer Bedienungsanleitung vor. Das Aussehen des Produkts hängt vom gelieferten Produkt ab. Bitte haben Sie Verständnis dafür, dass wir Sie nicht erneut über Technologie- oder Software-Updates informieren.

## **ANWEISUNGEN**

Vielen Dank, dass Sie sich für dieses Produkt entschieden haben. Bitte lesen Sie vor der Anwendung alle Anweisungen sorgfältig durch. Die Informationen helfen Ihnen, optimale Ergebnisse zu erzielen.

**BITTE BEACHTEN!** Die Zeichnungen in diesem Handbuch dienen nur zur Veranschaulichung und können in einigen Details vom tatsächlichen Produkt abweichen.

**ACHTUNG!** Lesen Sie alle Sicherheitshinweise und Anweisungen. Das in den Warnhinweisen verwendete Gerät oder Produkt bezieht sich auf Hochzeitsbogen - Hintergrund Stand .

Dieses Produkt ist kein Spielzeug und keine Spielzeugtruhe. Erlauben Sie Kindern nicht, mit diesem Artikel zu spielen. Bitte stellen Sie ihn so auf, dass Kinder nicht hochklettern können, um Verletzungen durch Stürze aus großer Höhe zu vermeiden.

## **SICHERHEIT BEI DER VERWENDUNG**

1. Stellen Sie vor der Installation sicher, dass sich alle im Handbuch beschriebenen Teile im Verpackungskarton befinden. Sollten Teile fehlen, wenden Sie sich bitte zunächst an Ihren Verkäufer.
2. Wählen Sie für die Montage einen Bereich aus, der sauber und frei von Fremdkörpern ist, über die Personen, die an der Montage arbeiten, stolpern könnten.
3. Sehen Sie sich die Montageanleitung in Ihrer Bedienungsanleitung an, bevor Sie fortfahren .
4. Überprüfen Sie die Maschine nach Abschluss der Montage gründlich, um sicherzustellen, dass alle Muttern und Schrauben richtig festgezogen wurden.
5. Dieses Produkt ist kein Klettergerüst oder Aufhängegerät und sollte nicht für andere Zwecke als den Hochzeitsbogen-Hintergrundständer verwendet werden .







## **SPEZIFIKATIONEN**

Modell	ABC-7,2 Fuß + 6 Fuß + BU
Farbe	Gold

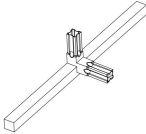





Produktgröße	7,2 x 4 Fuß , 6 x 2,6 Fuß
--------------	---------------------------

## TEILELISTE

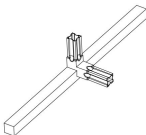
### 7,2 Fuß

											
A	X2	B	X1	C	X10	D	X1	E	X1	F	X3
											
Stoffbezug											
7,2 Fuß	X1										



### 6 Fuß

											
A	X2	B	X1	C	X9	D	X1	E	X1	F	X2



	
Stoffbezug	
6 Fuß	X1

## PRODUKTMONTAGE

7,2 Fuß

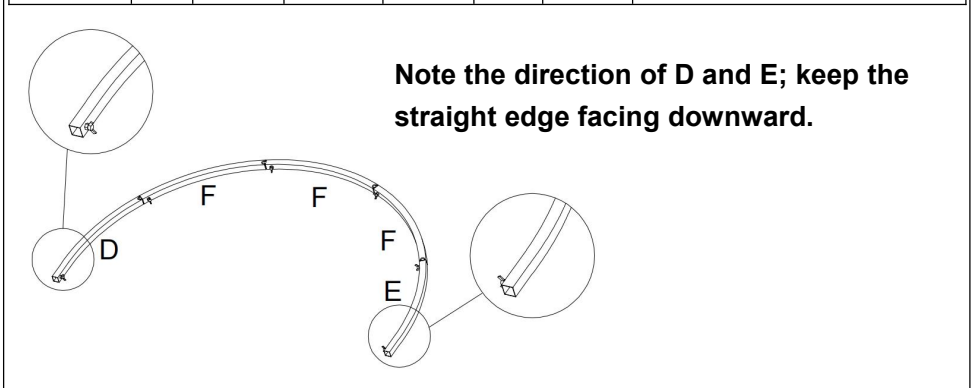
<b>SCHRITT 1</b>					
	D	X1	F	X3	E



<b>SCHRI TT 2</b>						
	<b>A</b>	<b>X2</b>	<b>B</b>	<b>X1</b>	<b>C</b>	<b>X10</b>

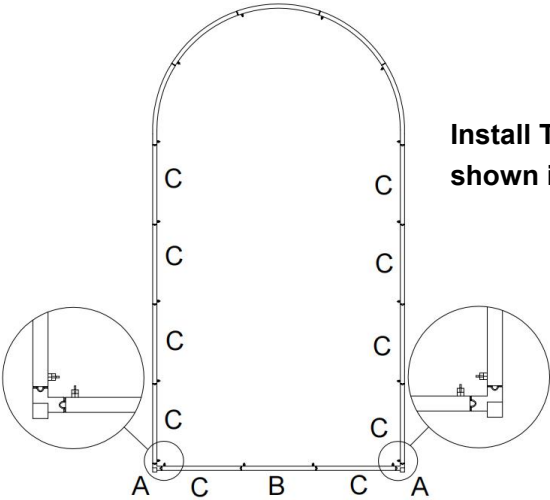

**Install Tube A in the direction shown in the diagram.**

**SCHRI  
TT 3**



Stoffbezug

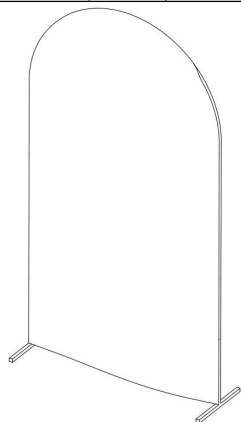

7,2  
Fuß

X1





Unfold the 7.2ft cloth cover and fit it into the background stand completed earlier.

# 6 Fuß

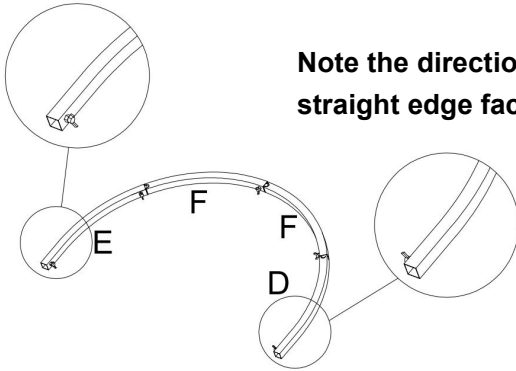
<b>SCHRI TT 1</b>							
	D	X1	F	X2	E	X1	



**Note the direction of D and E; keep the straight edge facing downward.**

<b>SCHRI TT 2</b>							
	<b>A</b>	X2	<b>B</b>	X1	<b>C</b>	X9	

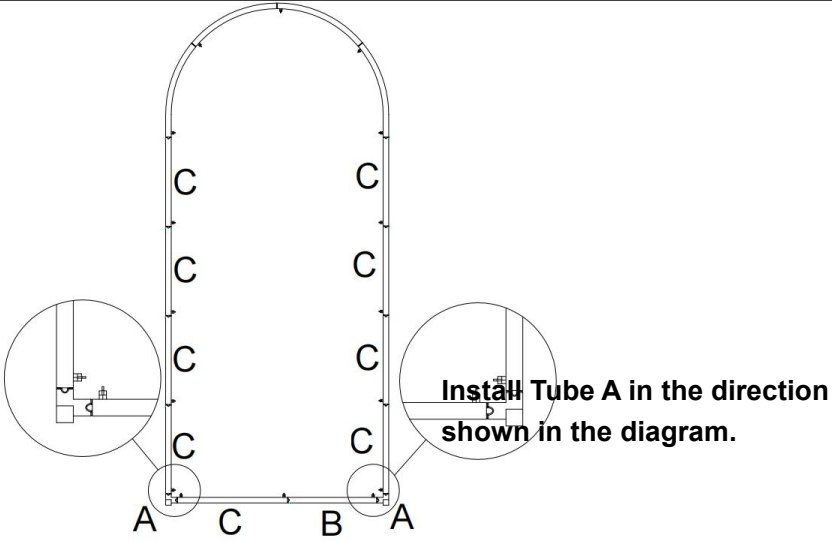

**SCHRI  
TT 3**



Stoffbezug

6  
Fuß

X1

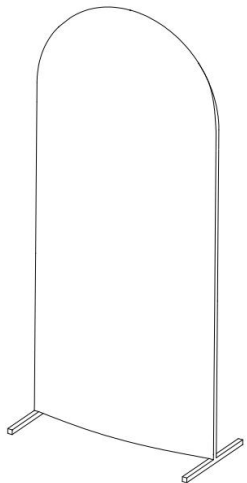

Unfold the 6ft cloth cover and fit it into the background stand completed earlier.

**Hersteller:** Shanghai muxinmuyeyouxiangongsi

**Adresse:** Shuangchenglu 803nong11hao1602A-1609shi, baoshanqu, Shanghai 200000 CN.

**Importiert nach AUS:** SIHAO PTY LTD. 1 ROKEVA STREET EASTWOOD NSW 2122 Australien

**Importiert in die USA:** Sanven Technology Ltd. Suite 250, 9166 Anaheim Place, Rancho Cucamonga, CA 91730

<b>UK</b>	<b>REP</b>
-----------	------------

YH CONSULTING LIMITED. C/O YH Consulting Limited Office 147, Centurion House, London Road, Staines-upon-Thames, Surrey, TW18 4AX

<b>EC</b>	<b>REP</b>
-----------	------------

E-CrossStu GmbH  
Mainzer Landstr.69,  
60329 Frankfurt am Main.





# VEVOR

**Affordable. Reliable. Home Improvement.**

**STOJAK NA TŁO ŁUKU ŚLUBNEGO**

**MODEL: ABC-7,2 stopy + 6 stóp + BU**



# VEVOR

Affordable. Reliable. Home Improvement.

WEDDING ARCH  
BACKDROP STAND

ABC-7,2 stopy + 6 stóp + BU

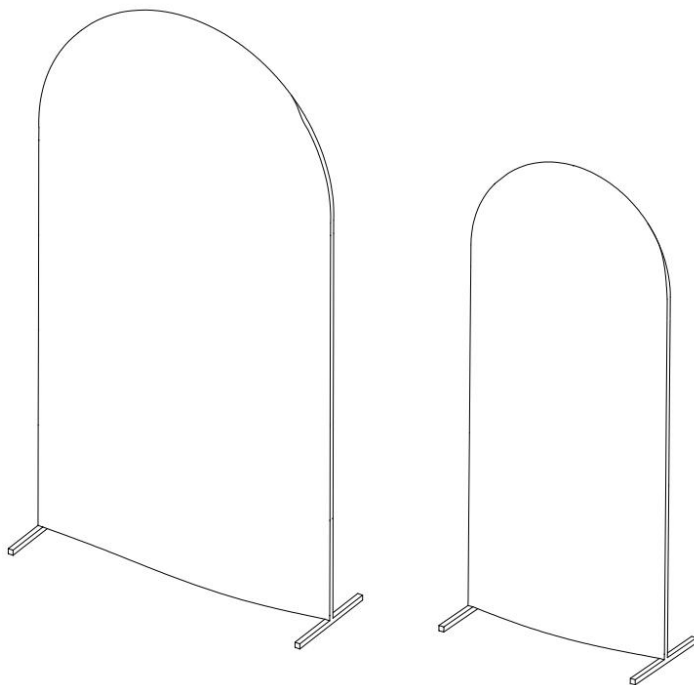

To jest oryginalna instrukcja obsługi. Przed użyciem prosimy o dokładne zapoznanie się z treścią instrukcji. Firma VEVOR zastrzega sobie prawo do jednoznacznej interpretacji niniejszej instrukcji obsługi. Wygląd produktu zależy od stanu, w jakim go otrzymali Państwo. Prosimy o wyrozumiałość, ale nie będziemy Państwa ponownie informować o aktualizacjach technologicznych lub oprogramowania naszego produktu.

## **INSTRUKCJE**

Dziękujemy bardzo za wybór tego produktu. Przed użyciem prosimy o zapoznanie się z instrukcją. Zawarte w niej informacje pomogą Państwu osiągnąć jak najlepsze rezultaty.

UWAGA! Rysunki w niniejszej instrukcji mają charakter wyłącznie poglądowy i w niektórych szczegółach mogą różnić się od rzeczywistego produktu.

UWAGA! Przeczytaj wszystkie ostrzeżenia dotyczące bezpieczeństwa i instrukcje. Urządzenie lub produkt, o którym mowa w instrukcji ostrzegawczej, jest określane jako tło łuku ślubnego. podstawka .

Ten produkt nie jest zabawką ani skrzynią na zabawki. Nie pozwalaj dzieciom bawić się tym przedmiotem. Umieść go w miejscu niedostępnym dla dzieci, aby uniknąć obrażeń w wyniku upadku z wysokości.

## **BEZPIECZEŃSTWO UŻYTKOWANIA**







1. Przed instalacją upewnij się, że części z instrukcji znajdują się w opakowaniu. Jeśli okaże się, że brakuje części, skontaktuj się najpierw ze sprzedawcą.
2. Wybierz miejsce montażu, które będzie czyste i wolne od wszelkich zanieczyszczeń, które mogłyby spowodować potknięcie się osób pracujących przy montażu.
3. Przed przystąpieniem do dalszych czynności zapoznaj się z instrukcją montażu w podręczniku operatora.
4. Po zakończeniu montażu należy dokładnie sprawdzić maszynę, aby mieć pewność, że wszystkie nakrętki i śruby zostały dokładnie dokręcone.
5. Ten produkt nie jest konstrukcją do wspinaczki ani urządzeniem do zawieszania i nie należy go używać. być używany do celów innych niż jako tło łuku weselnego.

## **SPECYFIKACJE**

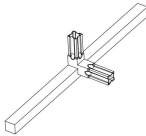





Model	ABC-7,2 stopy + 6 stóp + BU
Kolor	złoty stary
Rozmiar produktu	7,2*4 stopy , 6*2,6 stopy

## LISTA CZĘŚCI

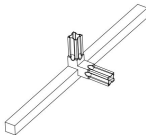
7,2 stopy

											
A	X2	B	X1	C	X10	D	X1	mi	X1	F	X3
											
Pokrowiec z tkaniny											
7,2 stopy	X1										

6 stóp

											
A	X2	B	X1	C	X9	D	X1	mi	X1	F	X2



Pokrowiec z  
tkaniny

6  
stóp

X1



## MONTAŻ PRODUKTU

7,2 stopy

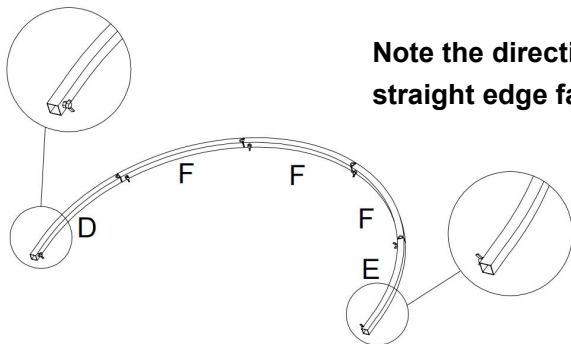
<b>KROK</b> <b>1</b>						
	D	X1	F	X3	mi	X1



**Note the direction of D and E; keep the  
straight edge facing downward.**

<b>KROK 2</b>						
	<b>A</b>	<b>X2</b>	<b>B</b>	<b>X1</b>	<b>C</b>	<b>X10</b>

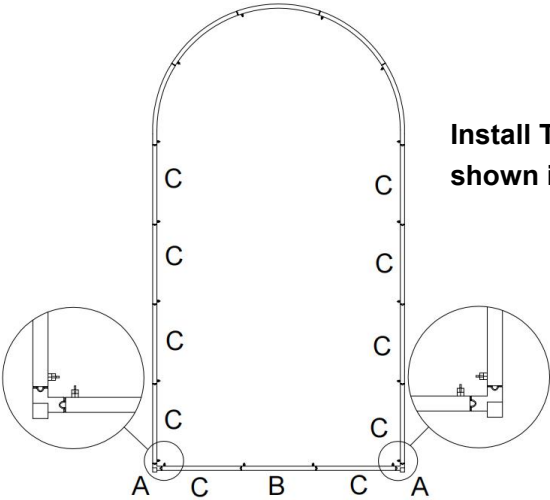

**Install Tube A in the direction shown in the diagram.**

**KROK  
3**



Pokrowiec  
z tkaniny

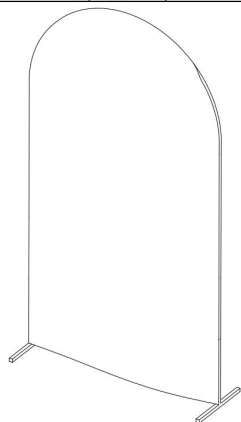

7,2  
stopy

X1





Unfold the 7.2ft cloth cover and fit it into the background stand completed earlier.

# 6 stóp

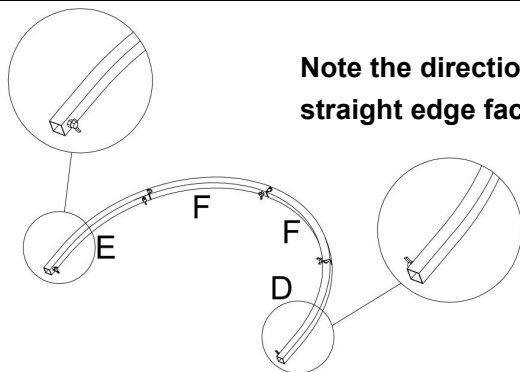
<b>KROK 1</b>					
	D	x1	F	x2	mi



**Note the direction of D and E; keep the straight edge facing downward.**

<b>KROK 2</b>							
	A	X2	B	X1	C	X9	

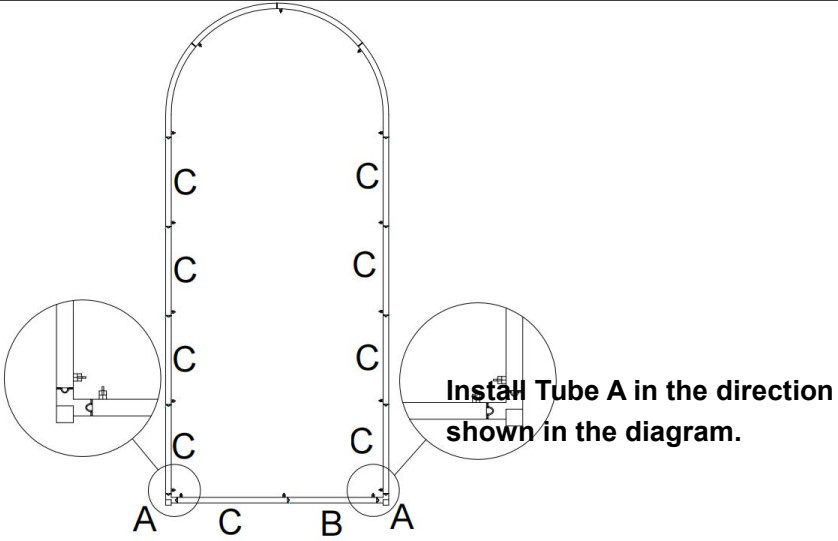

**KROK****3**Pokrowiec  
z tkaniny6  
stóp

X1

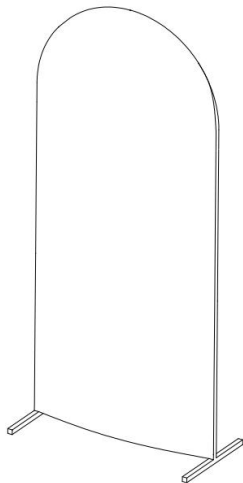

Unfold the 6ft cloth cover and fit it into the background stand completed earlier.

**Producent:** Shanghaimuxinmuyeyouxiangongsi

**Adres:** Shuangchenglu 803nong11hao1602A-1609shi, baoshanqu, szanghaj 200000 CN.

**Importowane do AUS:** SIHAO PTY LTD. 1 ROKEVA

STREETEASTWOOD

NSW 2122 Australia

**Importowane do USA:** Sanven Technology Ltd. Suite 250, 9166 Anaheim Miejsce, Rancho Cucamonga, CA 91730

<b>UK</b>	<b>REP</b>
-----------	------------

YH CONSULTING LIMITED. C/O YH Consulting  
Limited Office 147, Centurion House, London  
Road, Staines-upon-Thames, Surrey, TW18 4AX

<b>EC</b>	<b>REP</b>
-----------	------------

E-CrossStu GmbH  
Mainzer Landstr.69,  
60329 Frankfurt am Main.







# VEVOR

**Affordable. Reliable. Home Improvement.**

**SUPPORTO PER FONDALE AD ARCO PER**

**MATRIMONIO**

**MODELLO: ABC-7.2ft+6ft+BU**



# VEVOR

Affordable. Reliable. Home Improvement.

WEDDING ARCH  
BACKDROP STAND

ABC-7,2 piedi+6 piedi+BU

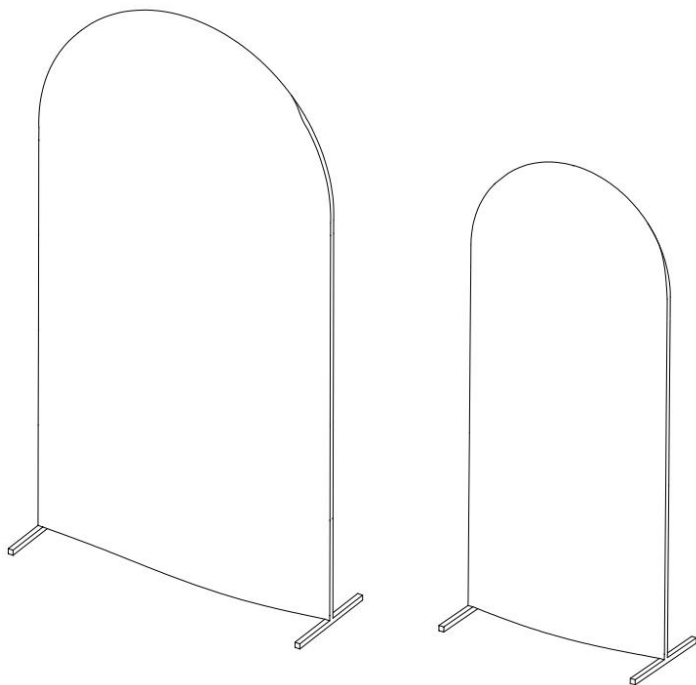

Queste sono le istruzioni originali, si prega di leggere attentamente tutte le istruzioni del manuale prima dell'uso. VEVOR si riserva la piena interpretazione del proprio manuale utente. L'aspetto del prodotto dipenderà dal prodotto ricevuto. Vi preghiamo di scusarci se non vi informeremo più in caso di aggiornamenti tecnologici o software sul nostro prodotto.

## ISTRUZIONI

Grazie mille per aver scelto questo prodotto. Leggere attentamente tutte le istruzioni prima di utilizzarlo. Queste informazioni vi aiuteranno a ottenere i migliori risultati possibili.

**ATTENZIONE!** I disegni presenti in questo manuale sono solo a scopo illustrativo e potrebbero differire in alcuni dettagli dal prodotto reale.

**ATTENZIONE!** Leggere tutte le avvertenze di sicurezza e tutte le istruzioni. Il dispositivo o il prodotto utilizzato nelle istruzioni di avvertenza si riferisce allo sfondo per arco da sposa in piedi .

Questo prodotto non è un giocattolo né una scatola portagiochi. Non permettere ai bambini di giocare con questo articolo. Posizionarlo in un punto in cui i bambini non possano arrampicarsi per evitare lesioni dovute a cadute dall'alto.

## SICUREZZA D'USO

1. Prima dell'installazione, assicurarsi che i componenti indicati nel manuale siano presenti nella confezione. Se si riscontrano componenti mancanti, contattare prima il venditore.
2. Selezionare un'area per l'assemblaggio pulita e priva di detriti che potrebbero far inciampare le persone che lavorano sull'assemblaggio.
3. Prima di procedere oltre , consultare le istruzioni di montaggio nel manuale dell'operatore.
4. Dopo aver completato il montaggio, ispezionare attentamente la macchina per accertarsi che tutti i dadi e i bulloni siano stati serrati a fondo.
5. Questo prodotto non è una struttura per arrampicarsi o uno strumento per appendere e non deve essere utilizzato per scopi diversi da quello di supporto per arco nuziale.

## SPECIFICHE

Modello	ABC-7,2 piedi+6 piedi+BU
Colore	oro
Dimensioni del prodotto	7,2*4 piedi , 6*2,6 piedi

## ELENCO DEI PEZZI

7,2 piedi

UN	X2	B	X1	C	X10	D	X1	E	X1	F	X3
Copertura in tessuto											
7,2 piedi	X1										

6 piedi

UN	X2	B	X1	C	X9	D	X1	E	X1	F	X2



Copertura in  
tessuto

6  
piedi

X1



## ASSEMBLAGGIO DEL PRODOTTO

7,2 piedi

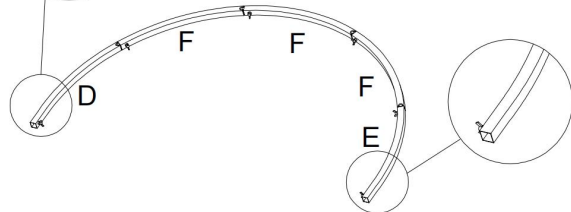
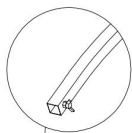
<b>PASS O 1</b>						
	D	X1	F	X3	E	X1



**Note the direction of D and E; keep the  
straight edge facing downward.**

<b>PASS O 2</b>						
	<b>U N</b>	X2	<b>B</b>	X1	<b>C</b>	X10

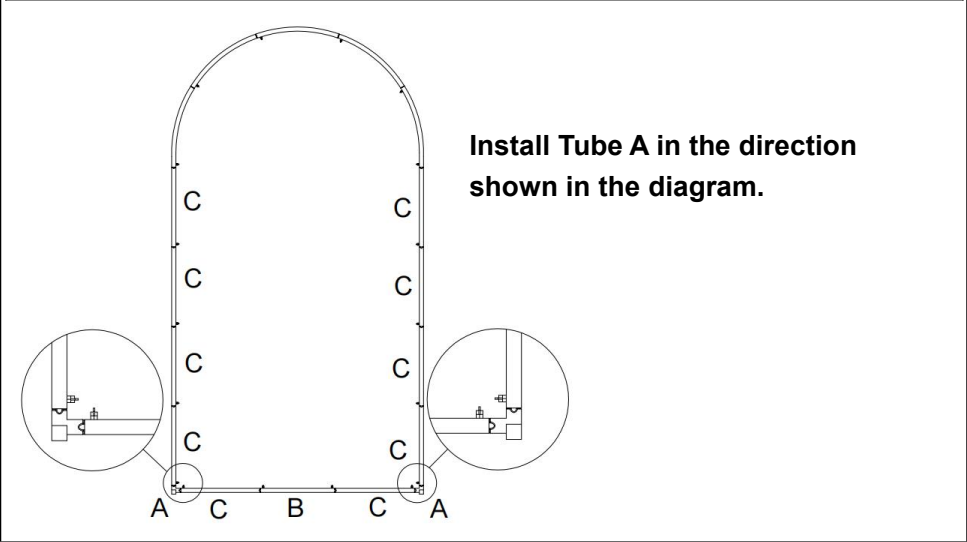

**PASS  
O 3**



Copertura  
in tessuto

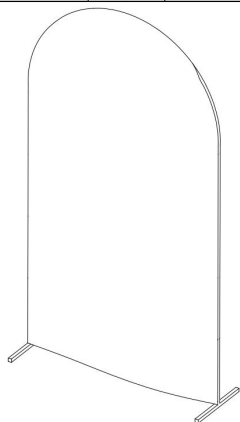

7,2  
piedi

X1



Unfold the 7.2ft cloth cover and fit it into the background stand completed earlier.

# 6 piedi

<b>PASS O 1</b>							
	D	X1	F	X2	E	X1	

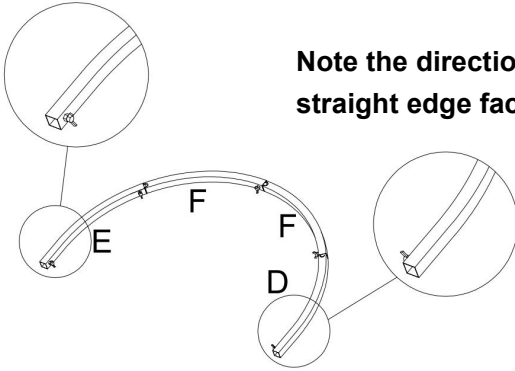

**Note the direction of D and E; keep the straight edge facing downward.**

PASS O 2						
	U N	X2	B	X1	C	X9

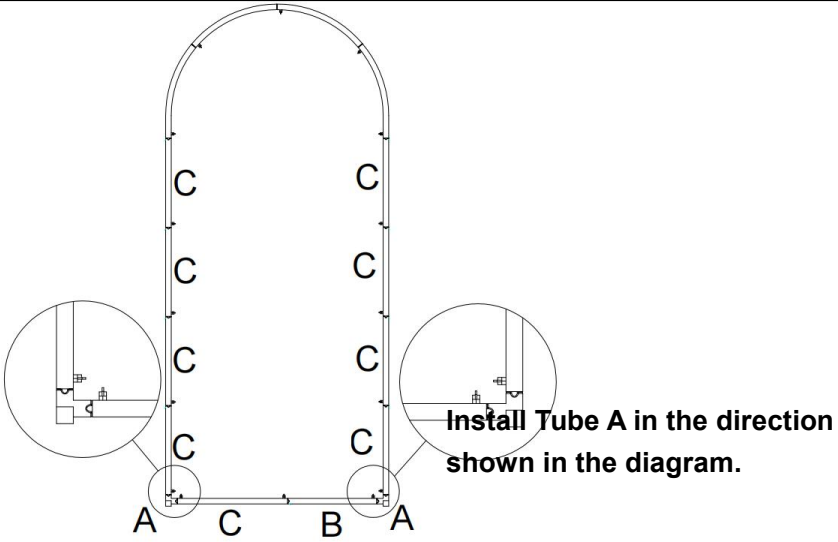

**PASS  
O 3**

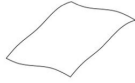

Copertura  
in tessuto

6  
piedi

X1

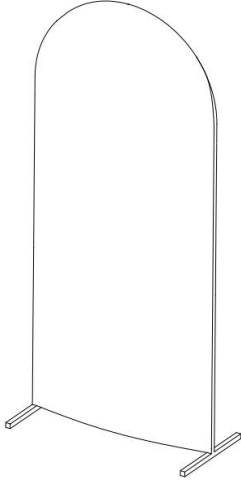

Unfold the 6ft cloth cover and fit it into the background stand completed earlier.

**Produttore:** Shanghaimuxinmuyeyouxiangongsi

**Indirizzo:** Shuangchenglu 803nong11hao1602A-1609shi, baoshanqu, Shanghai 200000 CN.

**Importato in AUS:** SIHAO PTY LTD. 1 ROKEVA STREETEASTWOOD Nuovo Galles del Sud 2122 Australia

**Importato negli USA:** Sanven Technology Ltd. Suite 250, 9166 Anaheim Luogo, Rancho Cucamonga, CA 91730

<b>UK</b>	<b>REP</b>
-----------	------------

YH CONSULTING LIMITED. C/O YH Consulting Limited Office 147, Centurion House, London Road, Staines-upon-Thames, Surrey, TW18 4AX

<b>EC</b>	<b>REP</b>
-----------	------------

E-CrossStu GmbH  
Mainzer Landstr.69,  
60329 Frankfurt am Main.



