

VEVOR

Upgrade · The Home Creator Way

Sliding Door Track

MODEL: XC40B-5FT



Video of installation

MODEL: XC40B-5FT

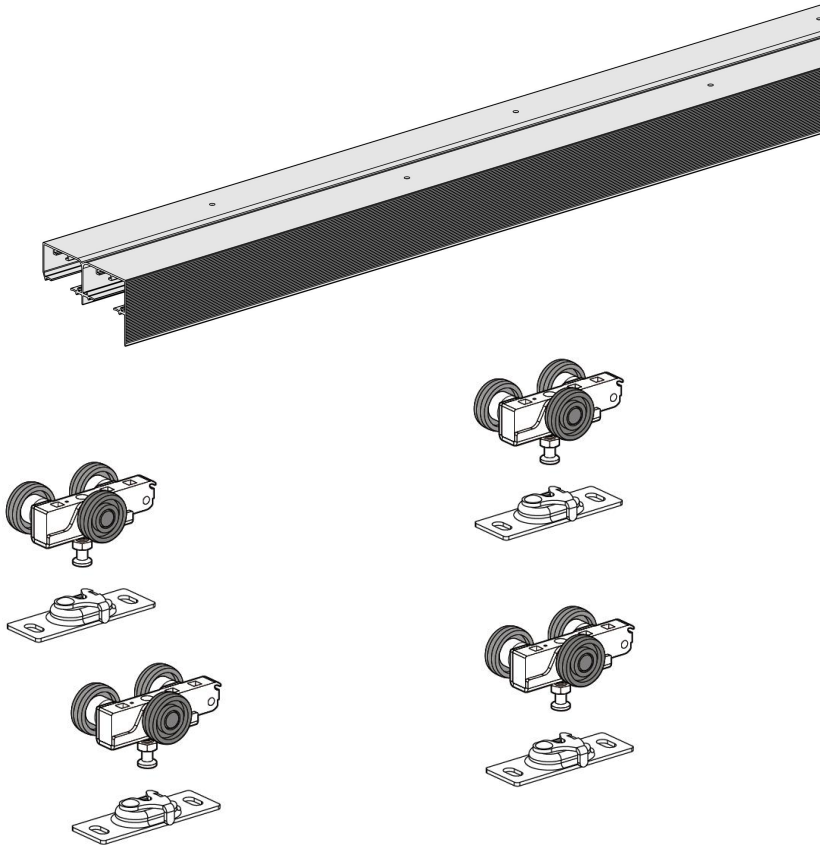

This is the original instruction, please read all manual instructions carefully before operating. VEVOR reserves a clear interpretation of our user manual. The appearance of the product shall be subject to the product you received. Please forgive us that we won't inform you again if there are any technology or software updates on our product.

INSTRUCTIONS

Thank you very much for choosing this Sliding Door Track.

- Please read all of the instructions before using it. The information will help you achieve the best possible results.

The products carried in this catalog may be different in color than the actual item.

SAVE THESE INSTRUCTIONS

WARNING:

Ensure Health and Safety, local authority and general workshop practice regulations are adhered to when using tools.

* DO NOT use tools if damaged.

* Maintain tools in good and clean condition for best and safest performance.

* Wear suitable clothing to avoid snagging. Do not wear loose jewellery and tie back long hair.

* Account for all tools and parts being used.

* If working off the vehicle, ensure that the workplace is secure and stable.

* Do Not use these tools if you are tired or under the influence of alcohol, drugs or intoxicating medication.

* PERSONAL SAFETY WARNING!

Always Wear personal protective equipment.

*PERSONAL PROTECTIVE EQUIPMENT

1. Always wear impact safety goggles that provide front and side protection for the eyes. Eye protection equipment should comply with CSA Z94.3-07 or ANSI Z87.1 standards based on the type of work performed.

2. Wear gloves that provide protection based on the work materials or to reduce the effects of tool vibration.



Conforms to relevant EU regulatory (CPR)305/2011 requirements.

Installation Manual

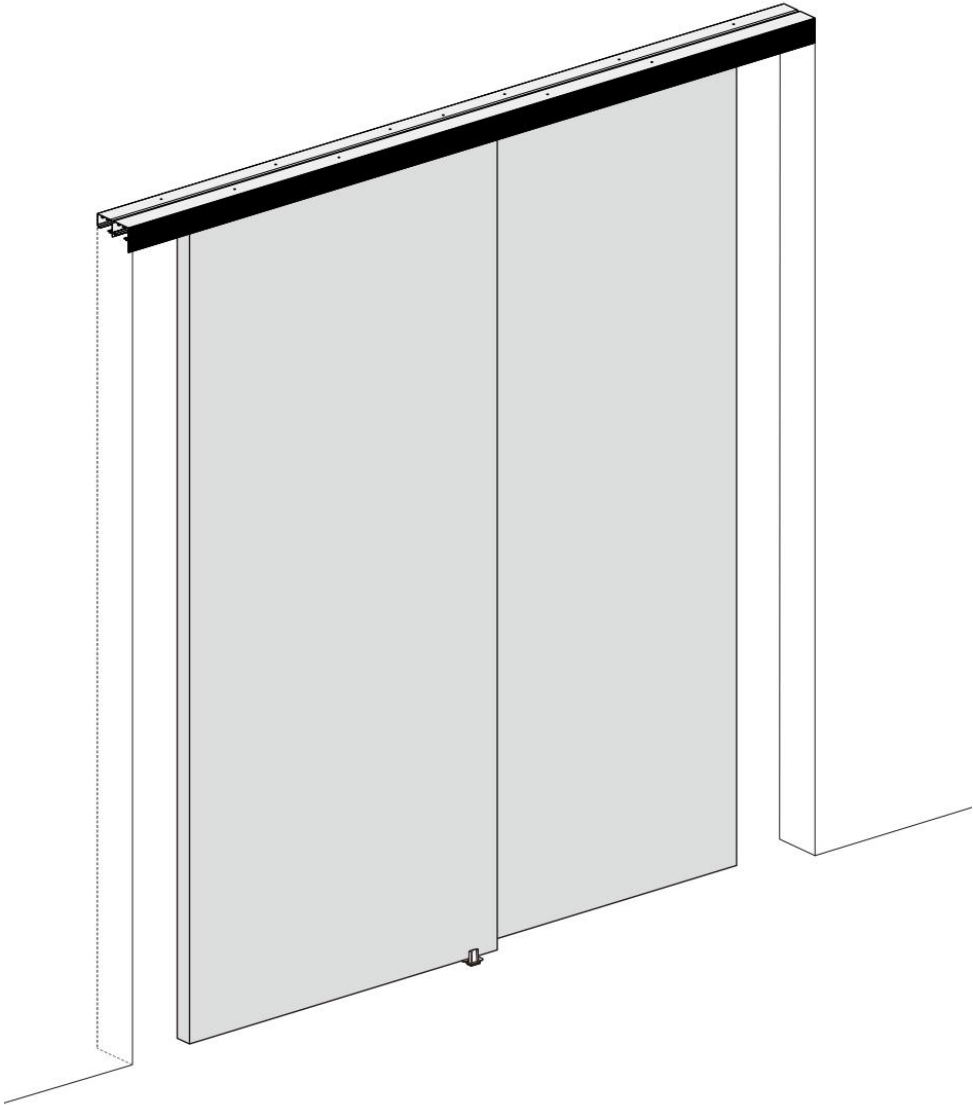

Components list

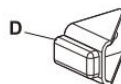
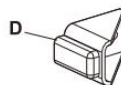
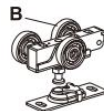
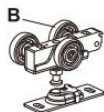
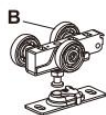
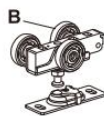
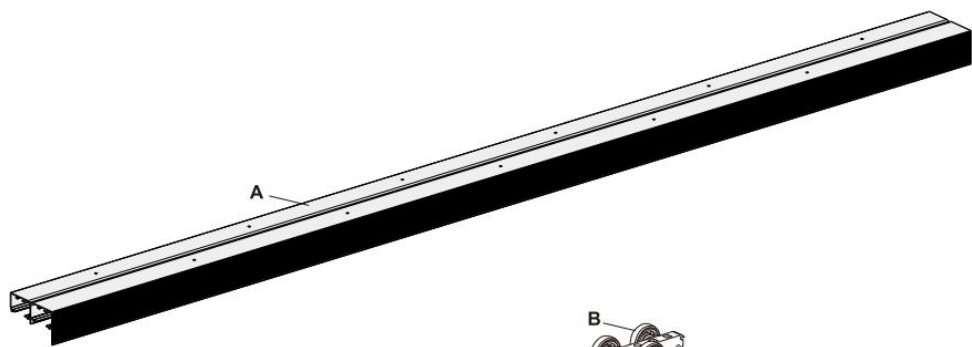

Technical Parameters and Parts List

Technical Parameters	
Name	Sliding Door Track
Model	XC40B-5FT
Track Classification	Double Track
Track Dimensions	60"(1524mm)
Soft Close	No
Load Capacity	300LBS(136kg)
Appearance Color	Black







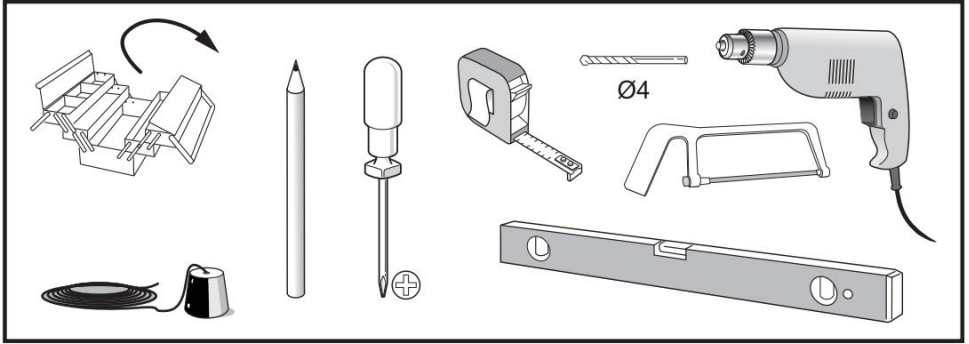

(XC40B-5FT) Parts List			
Name	Specification	Qty (pcs)	Notes
Track	/	1	Double
User Manual	/	1	
Hanger(Wheel Assembly)	/	4	Without Soft Close
Stopper	/	2	
Floor Guide	/	1	
Wrench	/	1	
Wall-mounting Screws	/	10	9 for actual use, 1 extra from manufacturer
Hanger Wheel Screws	/	9	8 for actual use, 1 extra from manufacturer
Anti-Sway Device Screws	/	3	2 for actual use, 1 extra from manufacturer
Stopper Screw	/	7	6 for actual use, 1 extra from manufacturer

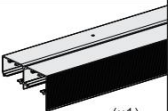
Pre-installation

TOOLS REQUIRED

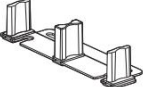

HARDWARE INCLUDED

A  ST4.2x32(x9)  (x1)	B  (x4)  ST5.5x32 (x8)	C  ST4.2x19 (x2)  (x1)
D  (x2)  ST4.2x19 (x6)	 (x1)	

Installation

Fits 35 and 45mm thick wood door
each door max weight 150lbs

2XDOOR

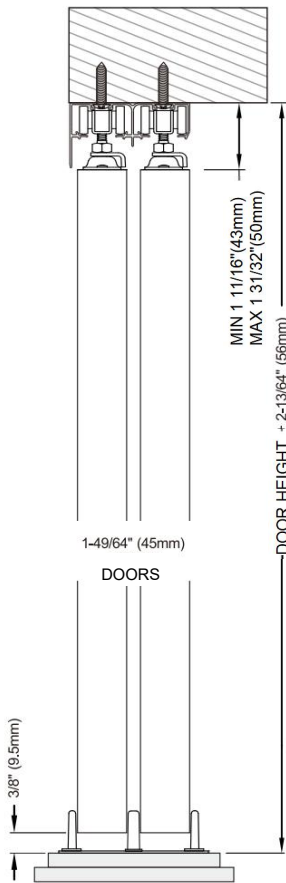
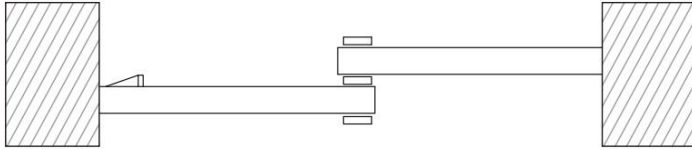

Installation

1

A

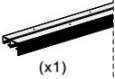

Install Track

Cut track to fit opening. Insert hangers into track and alternate wheel positions to distribute weight evenly. Mount track to header with screws.

ST4.2x32

B



2

B



Install Door Plates

Attach door plates on top of door 2-3/4" (70mm) from each edge with lock tabs on the same side.

ST5.5x32 (x8)

45mm DOOR

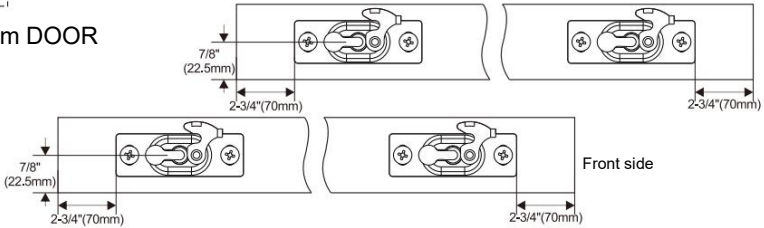

35mm DOOR

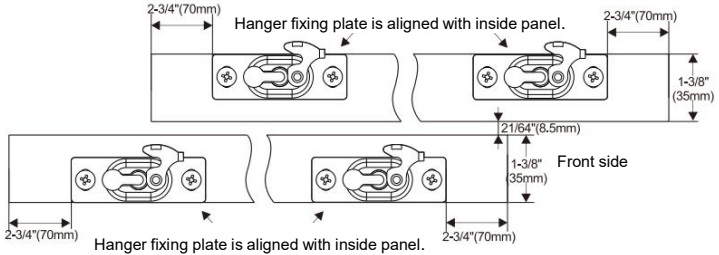

Installation

3

B

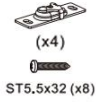

Hang Doors on Track

Hang Door on front leg of track first, Mount door by locating door plate under adjusting bolt of hanger and lock into place. Check for smooth travel. Repeat with rear door.

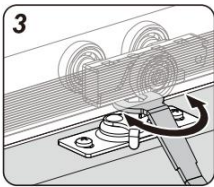
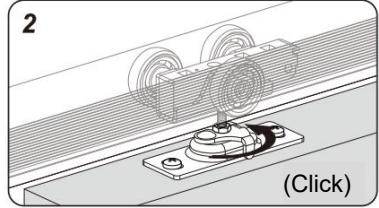
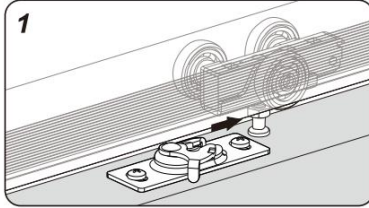

Use spanner to adjust door height

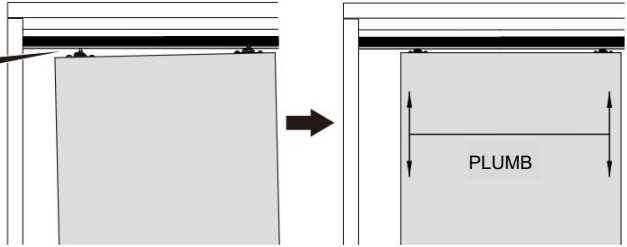

4

C

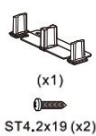

Install Floor Guide

Slide both doors to side jamb. Place guide between doors and position to plumb, then fasten to floor with screws.

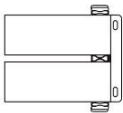

(default for 45 thick door)

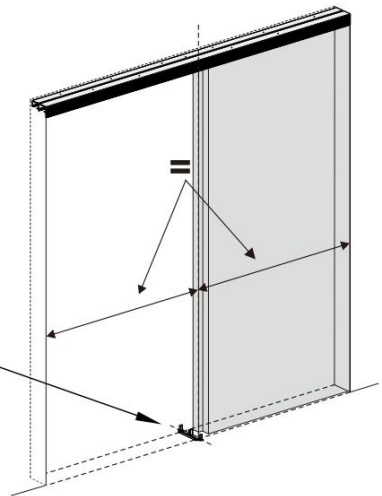

Installation

4

NOTE: Floor guide installation instruction for 35mm thick wood door :

1

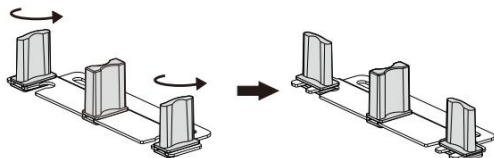

2

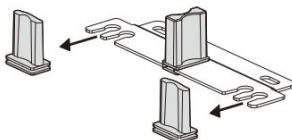

3

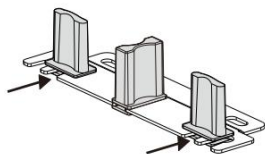

4

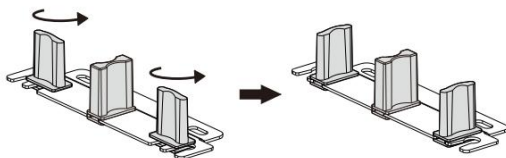

5

Door Adjustment

Use spanner to adjust door height through adjusting nut of hanger. Doors should plumb with jambs.

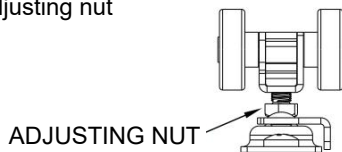

Installation

6

D



(x2)



ST4.2x19 (x6)

Install Door Stop
Attach door stop on the back of front door, 1-1/2"(38mm)
from door edge, 1/2"(13mm) from top (Hollow Core doors)
or 40"(100mm) from bottom (Solid Core doors). Note: if other than pull is used, adjust
location of stop to allow for access to rear door pull.

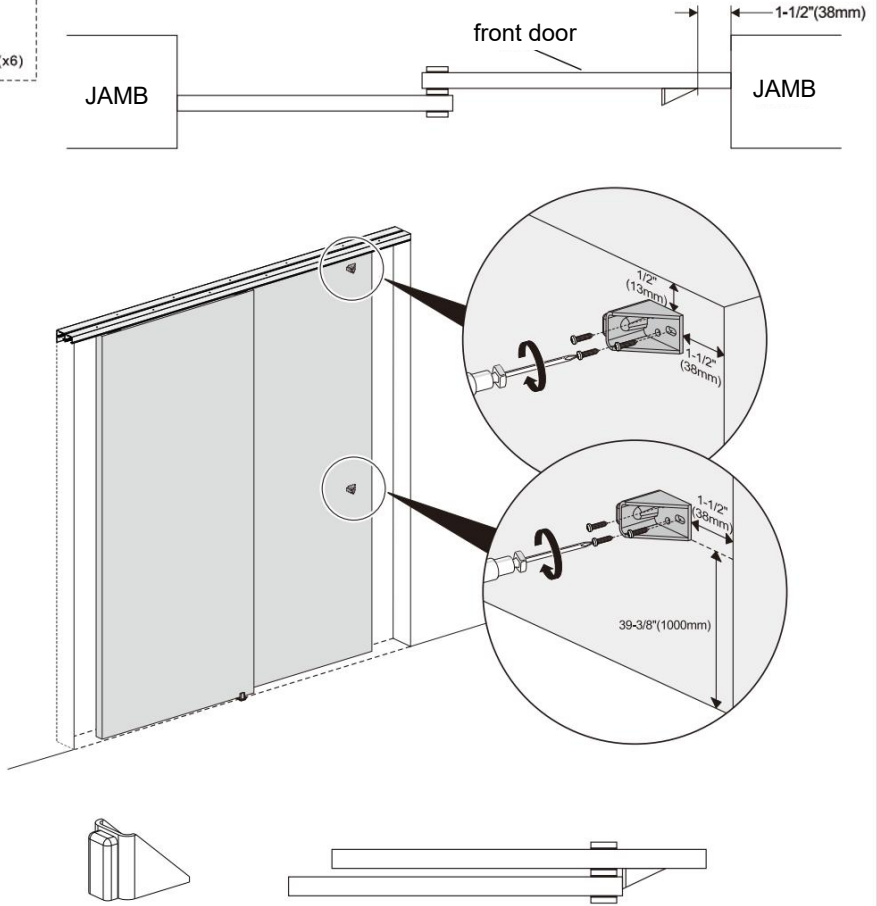

MAINTENANCE

1. Avoid prolonged exposure to the sun to avoid aging.

Manufacturer: Shanghaimuxinmuyeyouxiangongsi

Address: Shuangchenglu 803nong11hao1602A-1609shi, baoshanqu, shanghai 200000 CN.

Imported to AUS: SIHAO PTY LTD. 1 ROKEVA STREETEASTWOOD NSW 2122 Australia

Imported to USA: Sanven Technology Ltd. Suite 250, 9166 Anaheim Place, Rancho Cucamonga, CA 91730

UK	REP
-----------	------------

YH CONSULTING LIMITED. C/O YH Consulting Limited Office 147, Centurion House, London Road, Staines-upon-Thames, Surrey, TW18 4AX

EC	REP
-----------	------------

E-CrossStu GmbH
Mainzer Landstr.69,
60329 Frankfurt am Main.



VEVOR

Upgrade · The Home Creator Way

Riel para puerta corrediza

MODELO: XC40 B - 5 PIES



Vídeo de instalación

MODELO: XC40B-5FT

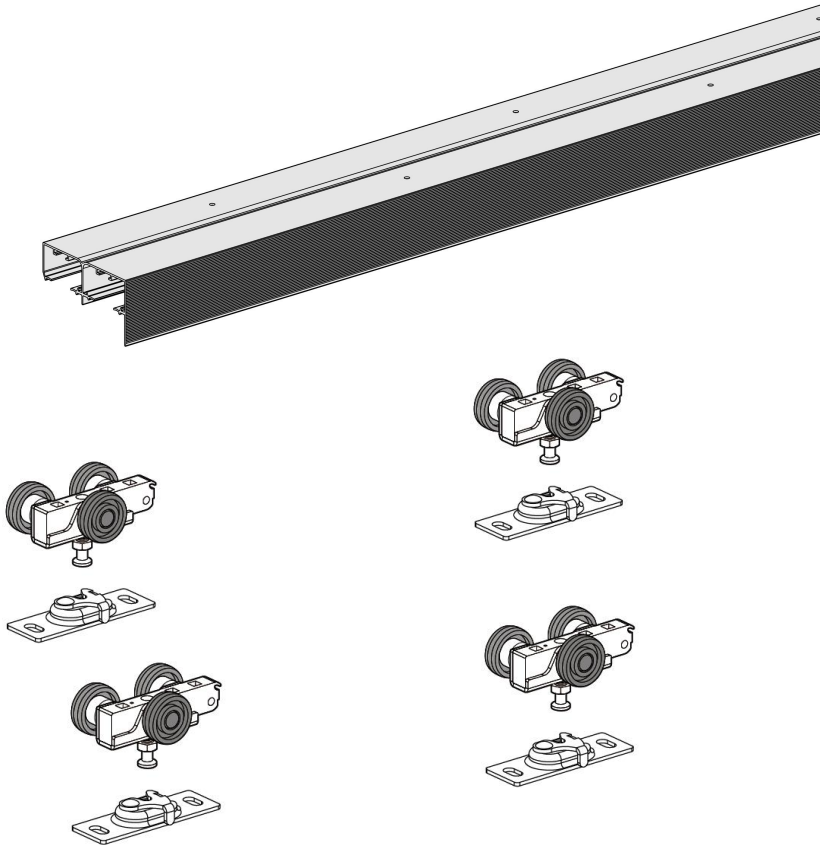

Estas son las instrucciones originales; lea atentamente todas las instrucciones del manual antes de utilizarlo. VEVOR se reserva el derecho de interpretar su manual de usuario. La apariencia del producto dependerá del producto que haya recibido. Le rogamos que nos disculpe si no le informamos de nuevo si hay actualizaciones tecnológicas o de software en nuestro producto.

INSTRUCTIONS

Muchas gracias por elegir este soporte para riel de puerta corrediza .
Lea todas las instrucciones antes de usarlo. Esta información le ayudará a obtener los mejores resultados posibles.
Los productos que aparecen en este catálogo pueden ser de color diferente al artículo real .

GUARDE ESTAS INSTRUCCIONES

ADVERTENCIA:

Garantizar la salud y la seguridad, las autoridades locales y las prácticas generales del taller.

Se respetan las normas al utilizar herramientas.

- * NO utilice herramientas si están dañadas.
- * Mantenga las herramientas en buenas condiciones y limpias para un rendimiento mejor y más seguro.
- * Use ropa adecuada para evitar enganches. No lleve joyas sueltas ni recoja el cabello largo.
- * Tenga en cuenta todas las herramientas y piezas que se utilizan.
- * Si trabaja fuera del vehículo, asegúrese de que el lugar de trabajo sea seguro y estable.

* No utilice estas herramientas si está cansado o bajo la influencia de alcohol, drogas o medicamentos intoxicantes.

* **SEGURIDAD PERSONAL ¡ADVERTENCIA!**

Use siempre equipo de protección personal.

* **EQUIPO DE PROTECCIÓN PERSONAL**

1. Use siempre gafas de seguridad contra impactos que protejan los ojos frontal y lateralmente. El equipo de protección ocular debe cumplir con las normas CSA Z94.3-07 o ANSI Z87.1, según el tipo de trabajo realizado.
2. Use guantes que proporcionen protección según los materiales de trabajo o para reducir los efectos de la vibración de la herramienta.



Cumple con los requisitos reglamentarios pertinentes de la UE (CPR)

305/2011 .

Manual de instalación

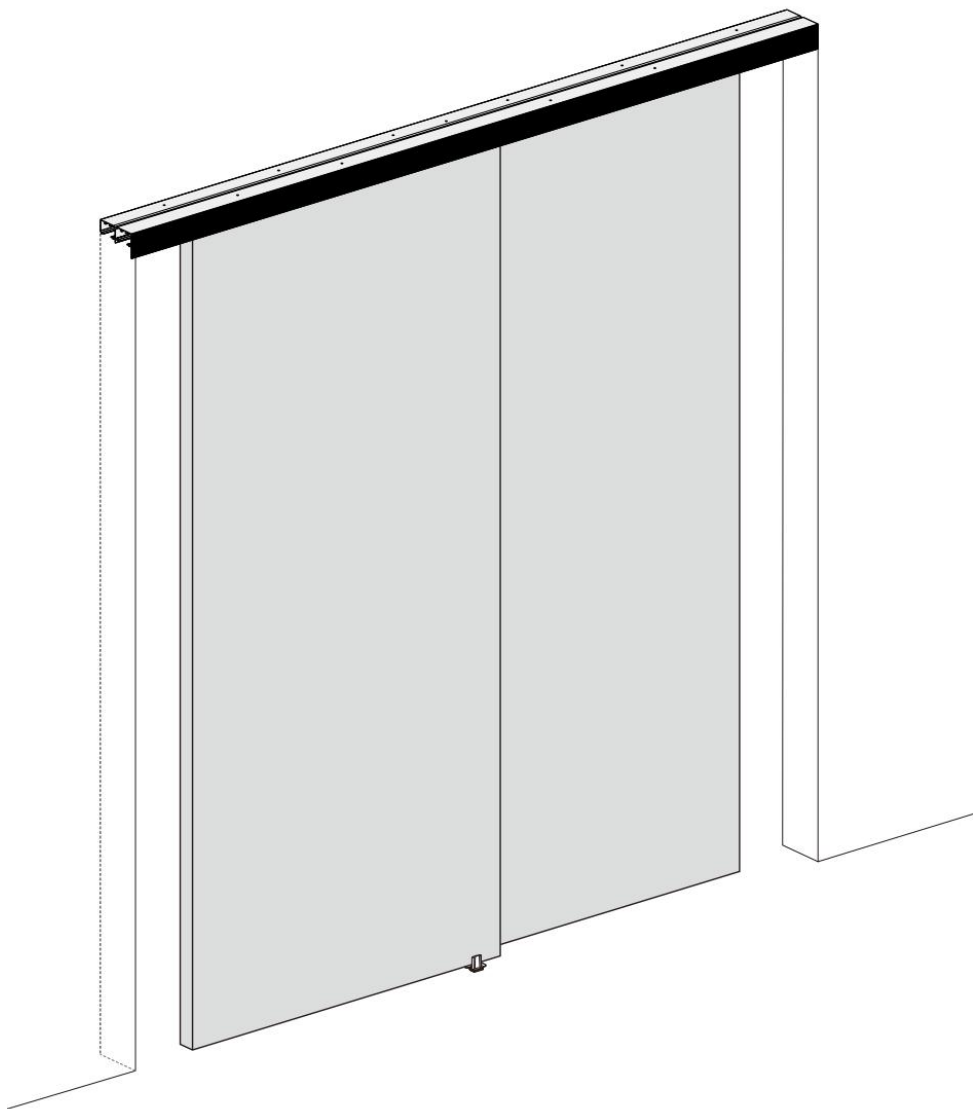

Lista de componentes

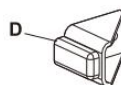
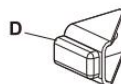
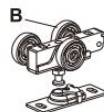
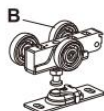
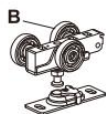
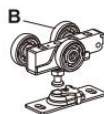
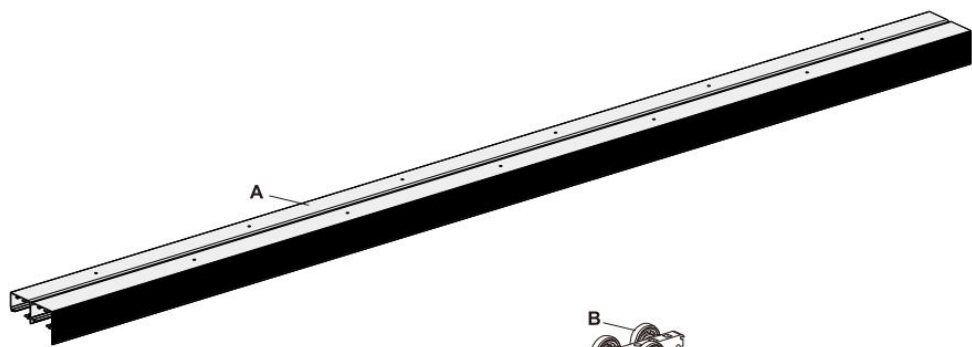

Parámetros técnicos y lista de piezas

Parámetros técnicos	
Nombre	Riel para puerta corrediza
Modelo	XC40B-5FT
Clasificación de pistas	Doble vía
Dimensiones de la pista	60 " (1524 mm)
Cierre suave	No
Capacidad de carga	300 libras (136 kg)
Apariencia Color	Negro

Lista de piezas (XC40B-5FT)			
Nombre	Especificación	Cantidad (uds.)	Notas
Pista	/	1	Doble
Manual del usuario	/	1	
Percha (conjunto de ruedas)	/	4	Sin cierre suave
Tapón	/	2	
Guía de suelos	/	1	
Llave inglesa	/	1	
Tornillos para montaje en pared	/	10	9 para uso real, 1 adicional del fabricante
Tornillos para ruedas de suspensión	/	9	8 para uso real, 1 adicional del fabricante
Tornillos del dispositivo antibalaceo	/	3	2 para uso real, 1 adicional del fabricante
Tornillo de tope	/	7	6 para uso real, 1 adicional del fabricante

Preinstalación

TOOLS REQUIRED

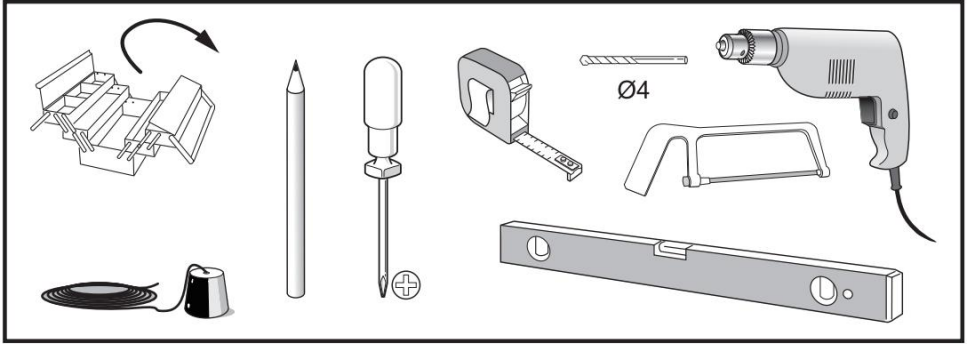

HARDWARE INCLUDED

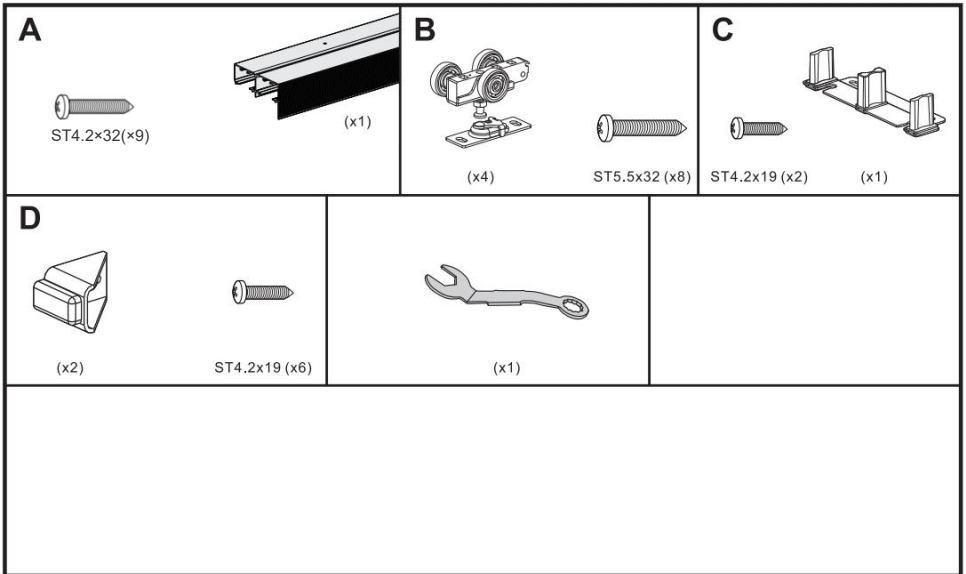

Instalación

Fits 35 and 45mm thick wood door
each door max weight 150lbs

2XDOOR

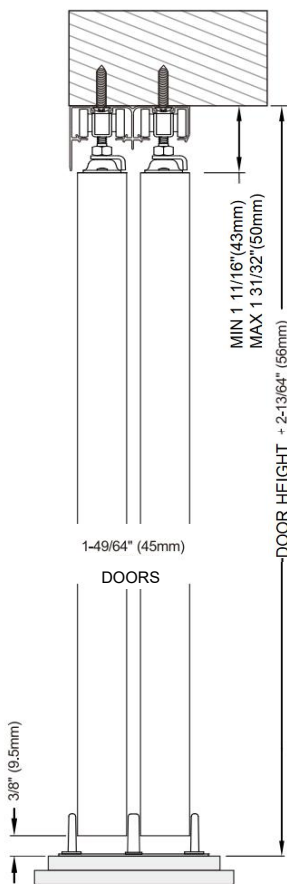
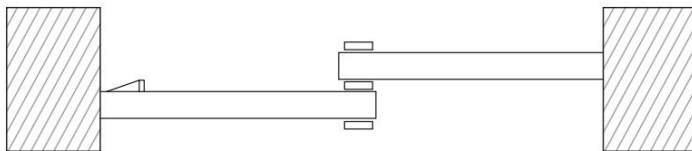

Instalación

1

A

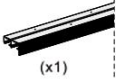

(x1)



ST4.2x32

Install Track

Cut track to fit opening. Insert hangers into track and alternate wheel positions to distribute weight evenly. Mount track to header with screws.

B



(x4)



2

B



(x4)



ST5.5x32 (x8)

Install Door Plates

Attach door plates on top of door 2-3/4" (70mm) from each edge with lock tabs on the same side.

45mm DOOR

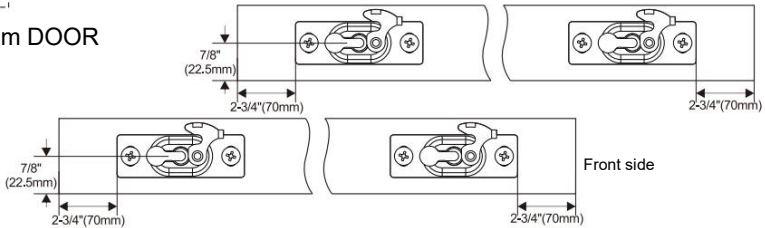

35mm DOOR

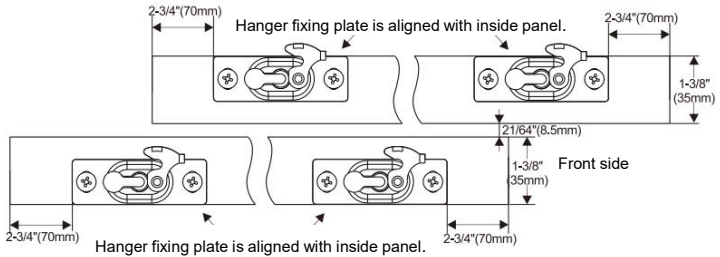

Instalación

3

B



(x4)



ST5.5x32 (x8)

Hang Doors on Track

Hang Door on front leg of track first, Mount door by locating door plate under adjusting bolt of hanger and lock into place. Check for smooth travel. Repeat with rear door.

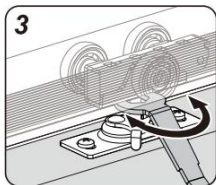
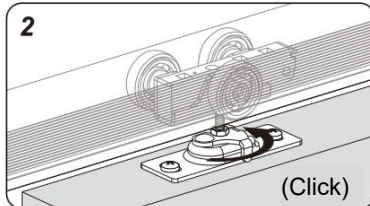
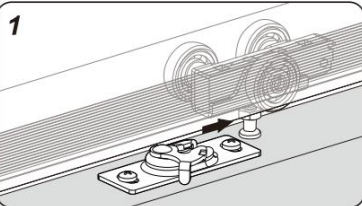

Use spanner to adjust door height

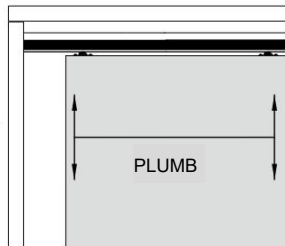
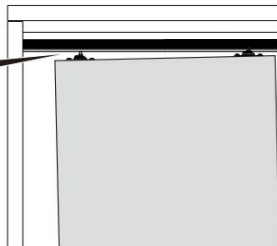

4

C



(x1)



ST4.2x19 (x2)

Install Floor Guide

Slide both doors to side jamb. Place guide between doors and position to plumb, then fasten to floor with screws.

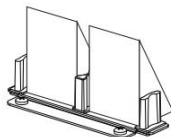
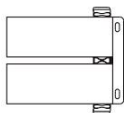

(default for 45 thick door)

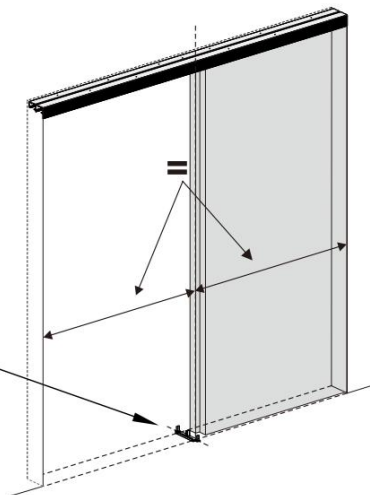

Instalación

4

NOTE: Floor guide installation instruction for 35mm thick wood door :

1

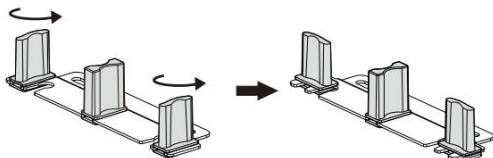

2

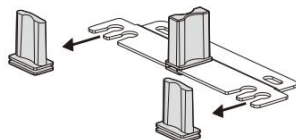

3

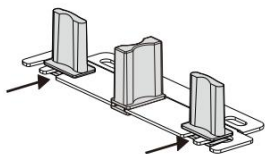

4

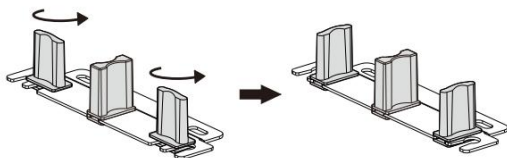

5

Door Adjustment

Use spanner to adjust door height through adjusting nut of hanger. Doors should plumb with jambs.

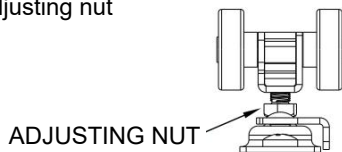

Instalación

6

D



(x2)



ST4.2x19 (x6)

Install Door Stop

Attach door stop on the back of front door, 1-1/2"(38mm) from door edge, 1/2"(13mm) from top (Hollow Core doors) or 40"(100mm) from bottom (Solid Core doors). Note: if other than pull is used, adjust location of stop to allow for access to rear door pull.

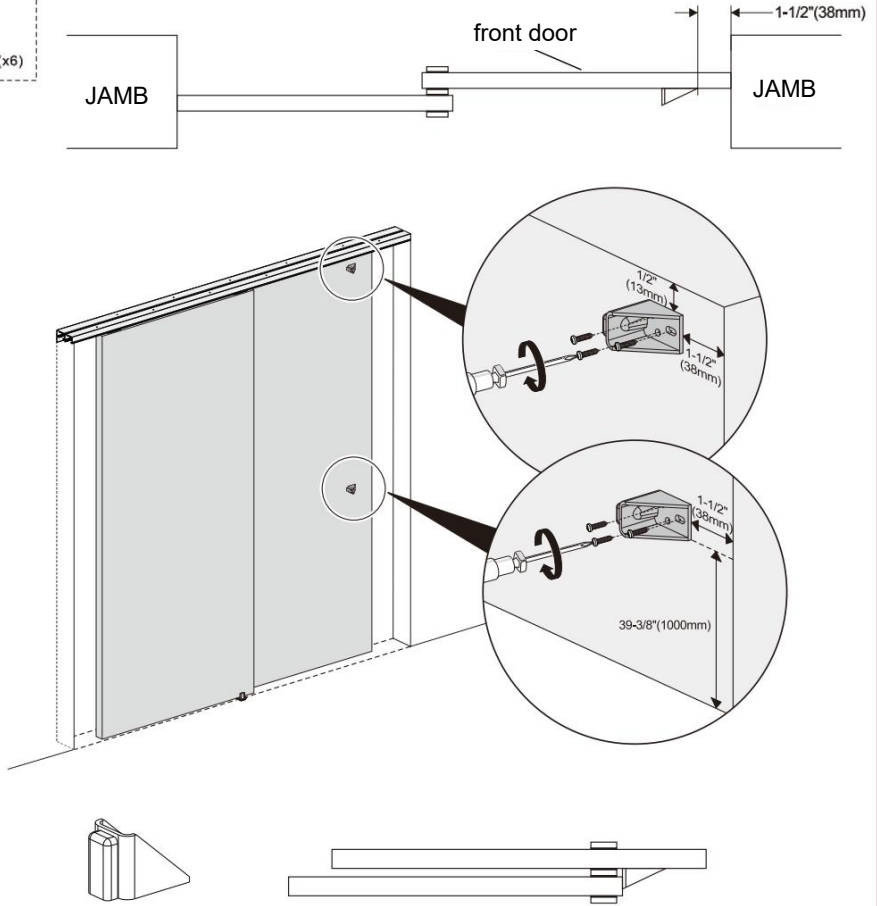

MAINTENANCE

2. Evite la exposición prolongada al sol para evitar el envejecimiento.

Fabricante: Shanghaimuxinmuyeyouxiangongsi

Dirección: Shuangchenglu 803nong11hao1602A-1609shi, baoshanqu, Shanghai 200000 CN.

Importado a AUS: SIHAO PTY LTD. 1 ROKEVA STREET EASTWOOD NSW 2122 Australia

Importado a EE. UU.: Sanven Technology Ltd. Suite 250, 9166 Anaheim Lugar, Rancho Cucamonga, CA 91730

UK	REP	YH CONSULTING LIMITED. C/O YH Consulting Limited Office 147, Centurion House, London Road, Staines-upon-Thames, Surrey, TW18 4AX
-----------	------------	--

EC	REP	E-CrossStu GmbH Mainzer Landstr.69, 60329 Frankfurt am Main.
-----------	------------	--



VEVOR

Upgrade · The Home Creator Way

Skjutdörrspår

MODELL: XC40 B - 1,5 METER



Video av installationen

MODELL: XC40B-5FT

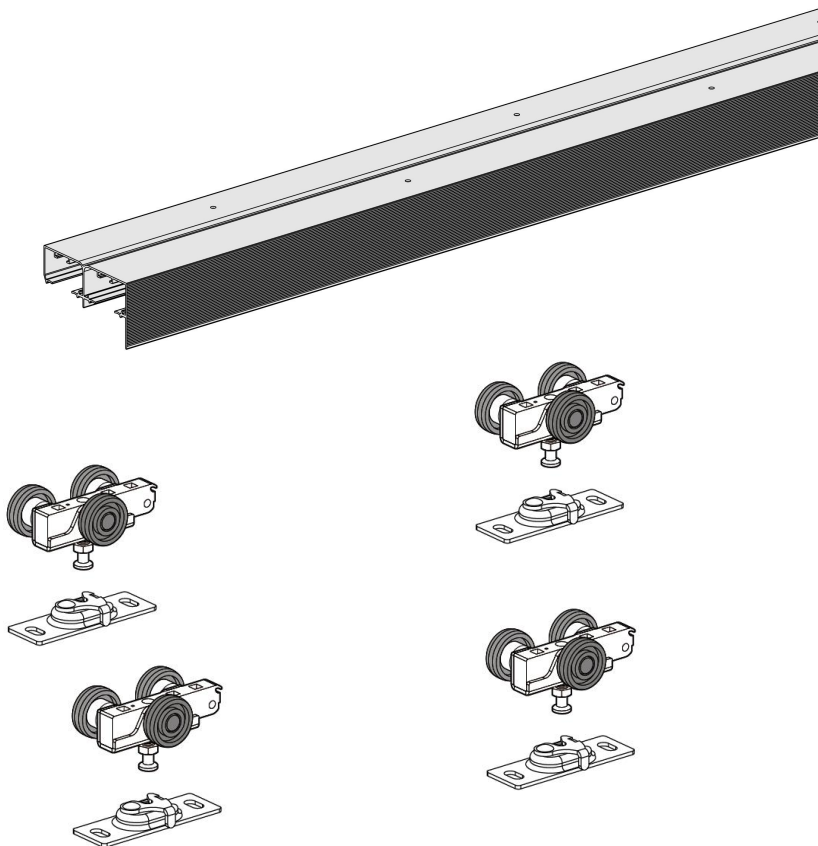

Detta är originalinstruktionerna, vänligen läs alla instruktioner noggrant innan du använder produkten. VEVOR förbehåller sig en tydlig tolkning av vår användarmanual. Produktens utseende ska vara beroende av den produkt du mottagit. Vi ber om ursäkt för att vi inte kommer att informera dig igen om det finns några teknik- eller programuppdateringar för vår produkt.

INSTRUCTIONS

Tack så mycket för att du valde **detta** skjutdörrsskenställ .

- Läs igenom alla instruktioner innan du använder den. Informationen hjälper dig att uppnå bästa möjliga resultat.

Produkterna i den här katalogen kan ha en annan färg än den faktiska varan .

SPARA DESSA INSTRUKTIONER

VARNING:

Säkerställ hälsa och säkerhet, lokala myndigheters och allmän verkstadspraxis

föreskrifter följs vid användning av verktyg.

* ANVÄND INTE verktyg om de är skadade.

* Håll verktygen i gott och rent skick för bästa och säkraste prestanda.

* Använd lämpliga kläder för att undvika att fastna. Bär inte lösa smycken och sätt inte upp långt hår.

* Redovisa alla verktyg och delar som används.

* Om du arbetar utanför fordonet, se till att arbetsplatsen är säker och stabil.

* Använd inte dessa verktyg om du är trött eller påverkad av alkohol, droger eller berusande läkemedel.

* PERSONLIG SÄKERHET VARNING!

Använd alltid personlig skyddsutrustning.

* PERSONLIG SKYDDSUSTRUSTNING

1. Använd alltid skyddsglasögon som ger skydd för ögonen framifrån och från sidan. Ögonskydd ska uppfylla standarderna CSA Z94.3-07 eller ANSI Z87.1 baserat på vilken typ av arbete som utförs.

2. Använd handskar som ger skydd baserat på arbetsmaterialet eller för att minska effekterna av verktygsvibrationer.



Uppfyller relevanta EU-förordningar (CPR) 305/2011 .

Installationsmanual

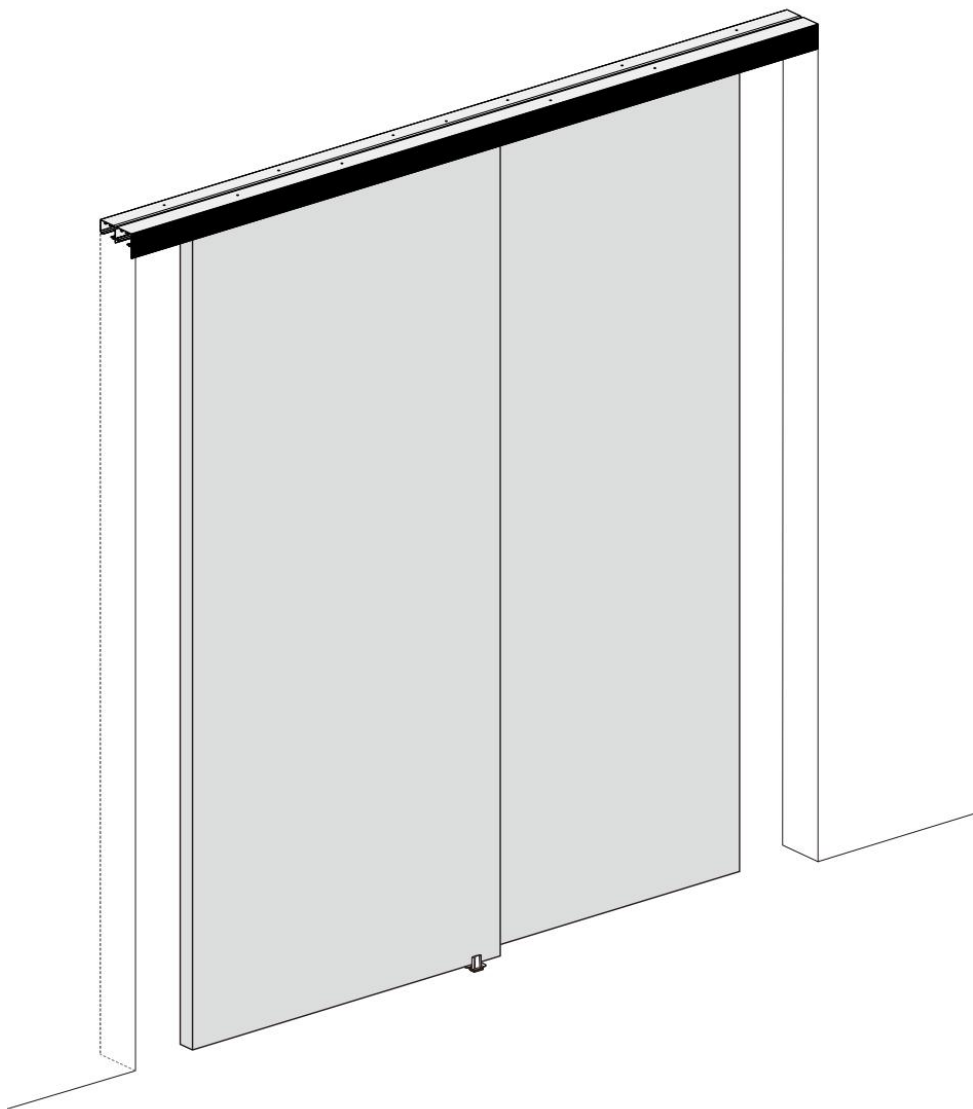

Komponentenliste

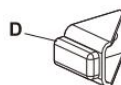
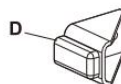
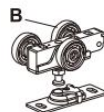
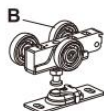
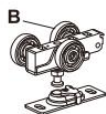
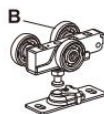
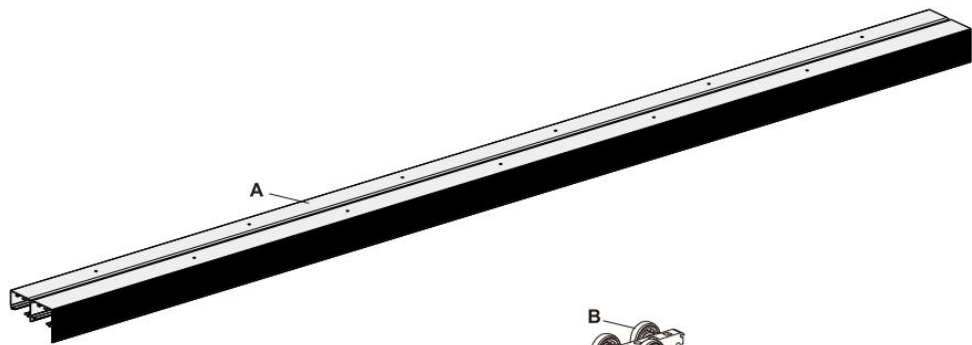

Tekniska parametrar och reservdelslista

Tekniska parametrar	
Namn	Skjutdörrsspår
Modell	XC40B-5FT
Banklassificering	Dubbelspår
Spårmått	60 tum (1524 mm)
Mjuk stängning	Inga
Lastkapacitet	136 kg
Utseende Färg	Svart

(XC40B-5FT) Dellista			
Namn	Specifikation	Antal (st)	Anteckningar
Spåra	/	1	Dubbel
Användarmanual	/	1	
Hängare (hjulmontering)	/	4	Utan mjukstängning
Propp	/	2	
Golvguide	/	1	
Rycka	/	1	
Väggmonteringsskruvar	/	10	9 för faktisk användning, 1 extra från tillverkaren
Hjulsruvar för hängare	/	9	8 för faktisk användning, 1 extra från tillverkaren
Skrubar för antisvängningsanordning	/	3	2 för faktisk användning, 1 extra från tillverkaren
Stoppskruv	/	7	6 för faktisk användning, 1 extra från tillverkaren

Förinstallation

TOOLS REQUIRED

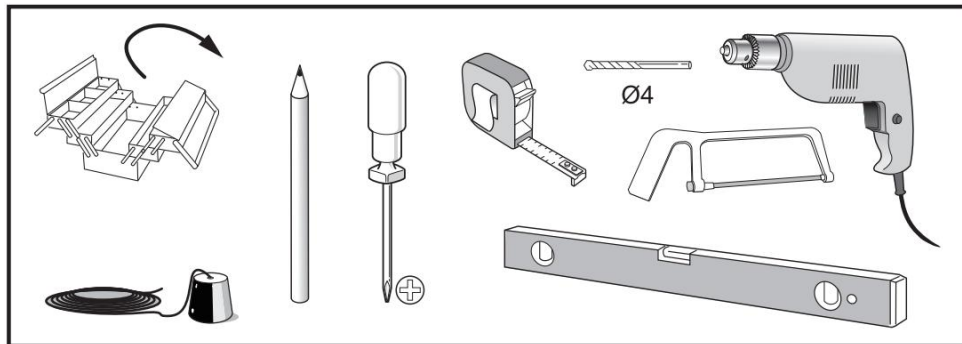

HARDWARE INCLUDED

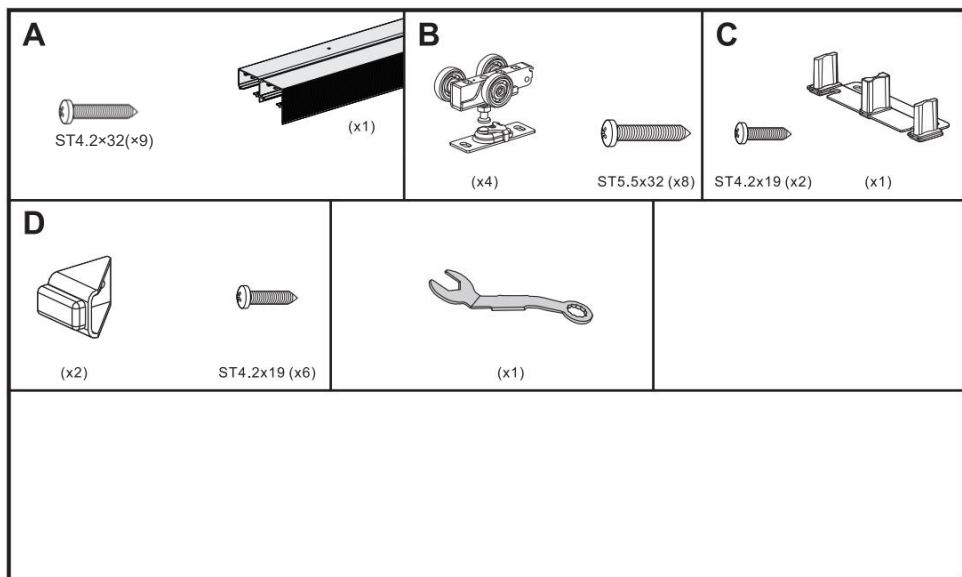

Installation

Fits 35 and 45mm thick wood door
each door max weight 150lbs

2XDOOR

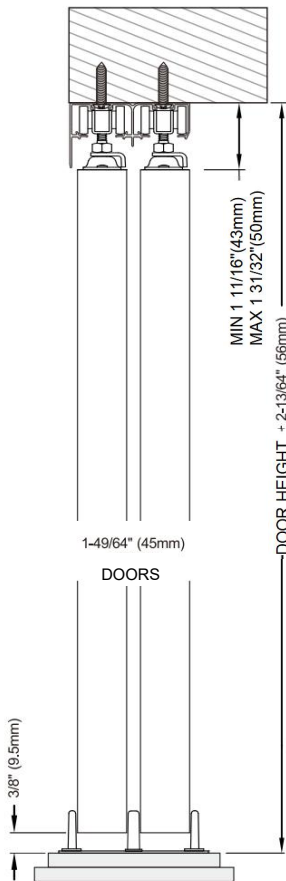
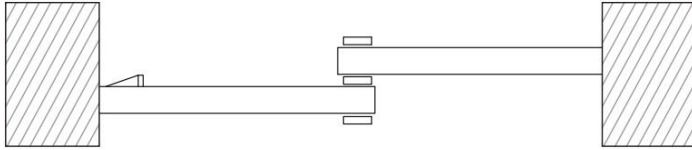

Installation

1

A

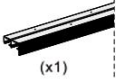

(x1)



ST4.2x32

Install Track

Cut track to fit opening. Insert hangers into track and alternate wheel positions to distribute weight evenly. Mount track to header with screws.

B



(x4)



2

B



(x4)



ST5.5x32 (x8)

Install Door Plates

Attach door plates on top of door 2-3/4" (70mm) from each edge with lock tabs on the same side.

45mm DOOR

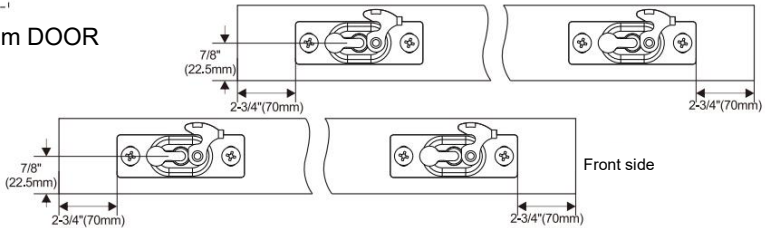

35mm DOOR

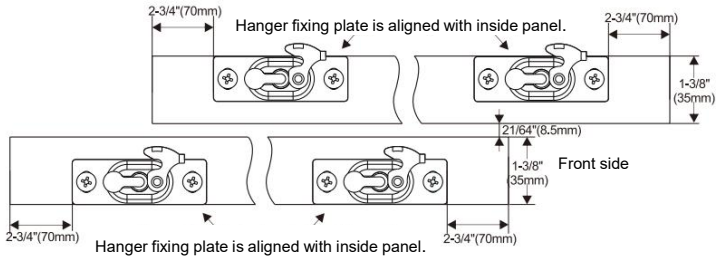

Installation

3

B

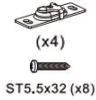

Hang Doors on Track

Hang Door on front leg of track first, Mount door by locating door plate under adjusting bolt of hanger and lock into place. Check for smooth travel. Repeat with rear door.

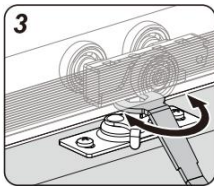
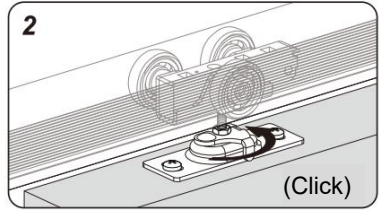
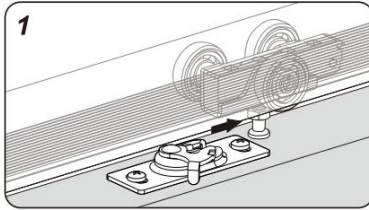

Use spanner to adjust door height

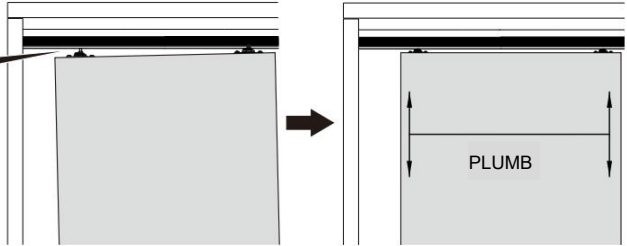

4

C

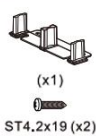

Install Floor Guide

Slide both doors to side jamb. Place guide between doors and position to plumb, then fasten to floor with screws.

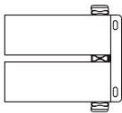

(default for 45 thick door)

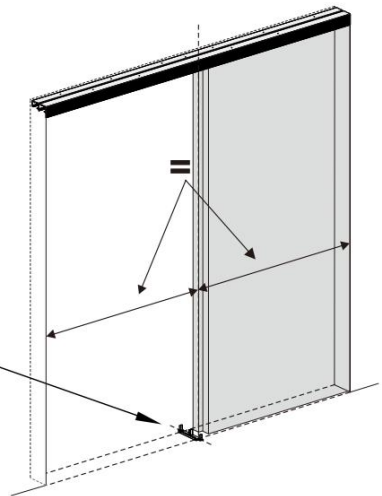

Installation

4

NOTE: Floor guide installation instruction for 35mm thick wood door :

1

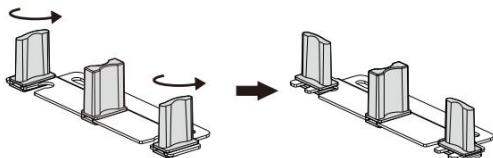

2

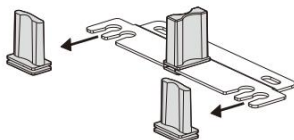

3

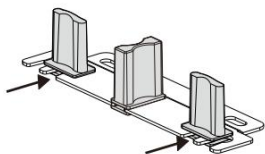

4

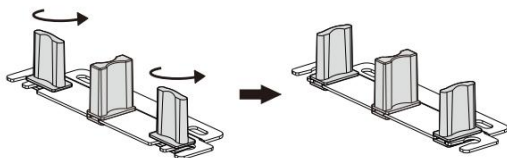

5

Door Adjustment

Use spanner to adjust door height through adjusting nut of hanger. Doors should plumb with jambs.

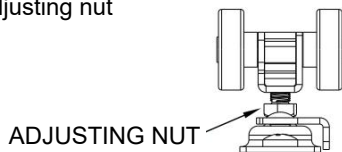

Installation

6

D



(x2)



ST4.2x19 (x6)

Install Door Stop

Attach door stop on the back of front door, 1-1/2"(38mm) from door edge, 1/2"(13mm) from top (Hollow Core doors) or 40"(100mm) from bottom (Solid Core doors). Note: if other than pull is used, adjust location of stop to allow for access to rear door pull.

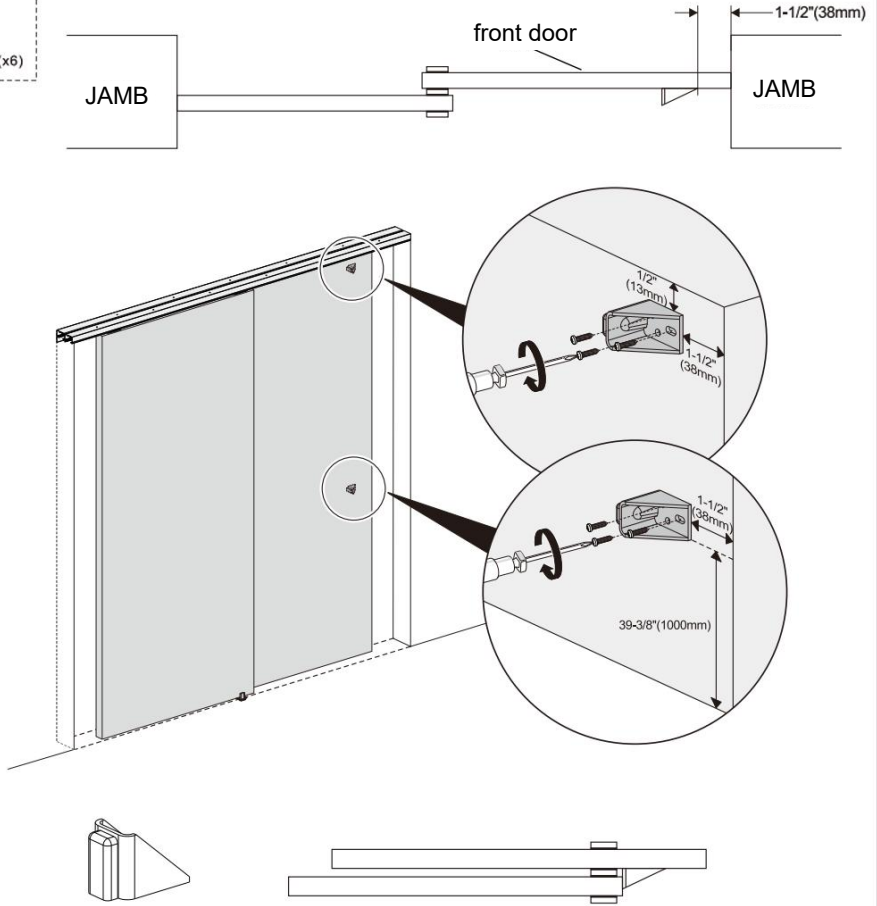

MAINTENANCE

3. Undvik långvarig exponering för solen för att förhindra åldrande.

Tillverkare: Shanghaimuxinmuyeyouxiangongsi

Adress: Shuangchenglu 803nong11hao1602A-1609shi, baoshanqu, Shanghai 200 000 kanadensiska republiken.

Importerad till Australien: SIHAO PTY LTD. 1 ROKEVA
STREETEASTWOOD

NSW 2122 Australien

Importerad till USA: Sanven Technology Ltd. Suite 250, 9166 Anaheim
Plats, Rancho Cucamonga, Kalifornien 91730

UK	REP
-----------	------------

YH CONSULTING LIMITED. C/O YH Consulting
Limited Office 147, Centurion House, London
Road, Staines-upon-Thames, Surrey, TW18 4AX

EC	REP
-----------	------------

E-CrossStu GmbH
Mainzer Landstr.69,
60329 Frankfurt am Main.



VEVOR

Upgrade · The Home Creator Way

Schuifdeurraail

MODEL: XC40 B - 5 FT



Video van de installatie

MODEL: XC40B-5FT

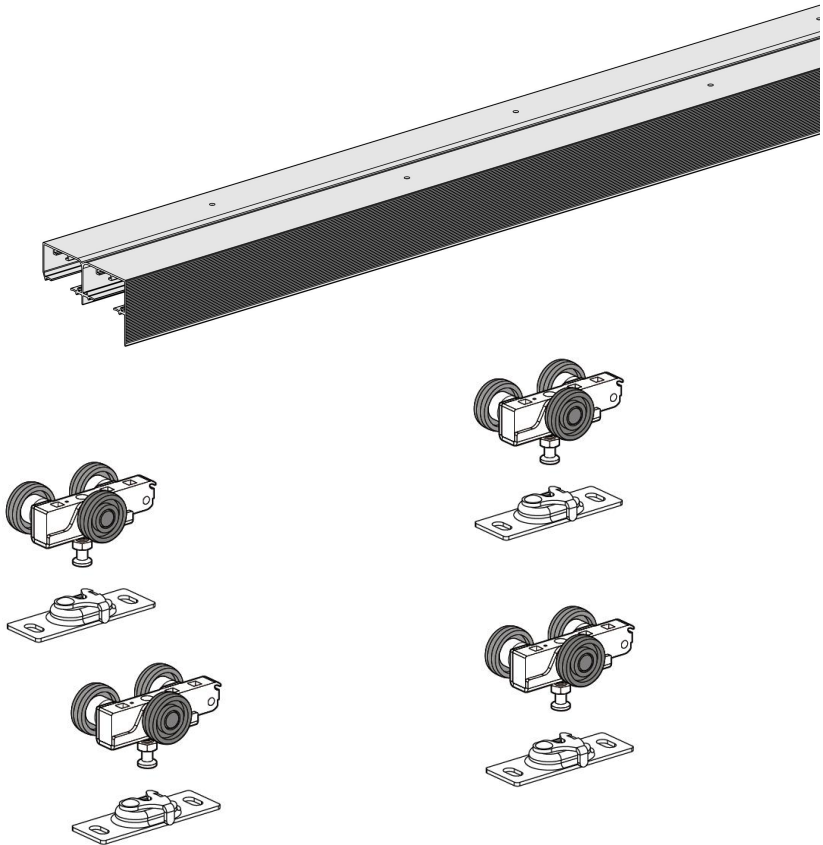

Dit is de originele handleiding. Lees alle instructies zorgvuldig door voordat u het product gebruikt. VEVOR behoudt zich het recht voor om de gebruiksaanwijzing duidelijk te interpreteren. Het uiterlijk van het product is afhankelijk van het product dat u hebt ontvangen. Neemt u het ons niet kwalijk dat we u niet meer op de hoogte stellen van eventuele technologische of software-updates voor ons product.

INSTRUCTIONS

Hartelijk dank dat u voor deze schuifdeurrail hebt **gekozen** .

- Lees alle instructies aandachtig door voordat u het product gebruikt. Deze informatie helpt u de best mogelijke resultaten te behalen.

De in deze catalogus vermelde producten kunnen qua kleur afwijken van het daadwerkelijke artikel .

BEWAAR DEZE INSTRUCTIES

WAARSCHUWING:

Zorg voor gezondheid en veiligheid, lokale autoriteiten en algemene werkplaatspraktijken

bij het gebruik van gereedschap worden de voorschriften in acht genomen.

* **GEBRUIK GEEN** gereedschap als het beschadigd is.

* Zorg ervoor dat het gereedschap in goede en schone staat verkeert voor de beste en veiligste prestaties.

* Draag geschikte kleding om vasthaken te voorkomen. Draag geen losse sieraden en bind lang haar vast.

* Houd bij welke gereedschappen en onderdelen u gebruikt.

* Als u buiten het voertuig werkt, zorg er dan voor dat de werkplek veilig en stabiel is.

* **Gebruik** deze hulpmiddelen niet als u moe bent of onder invloed bent van alcohol, drugs of bedwelmende medicijnen.

* **PERSOONLIJKE VEILIGHEIDSWAARSCHUWING!**

Draag altijd persoonlijke beschermingsmiddelen.

* **PERSOONLIJKE BESCHERMINGSMIDDELEN**

1. Draag altijd een veiligheidsbril die de ogen aan de voor- en zijkant beschermt. Oogbescherming moet voldoen aan de CSA Z94.3-07- of ANSI Z87.1-normen, afhankelijk van het soort werk dat wordt uitgevoerd.

2. Draag handschoenen die bescherming bieden op basis van het materiaal waarmee wordt gewerkt of om de effecten van gereedschapstrillingen te verminderen.



Voldoet aan de relevante EU-regelgeving (CPR) 305/2011 .

Installatiehandleiding

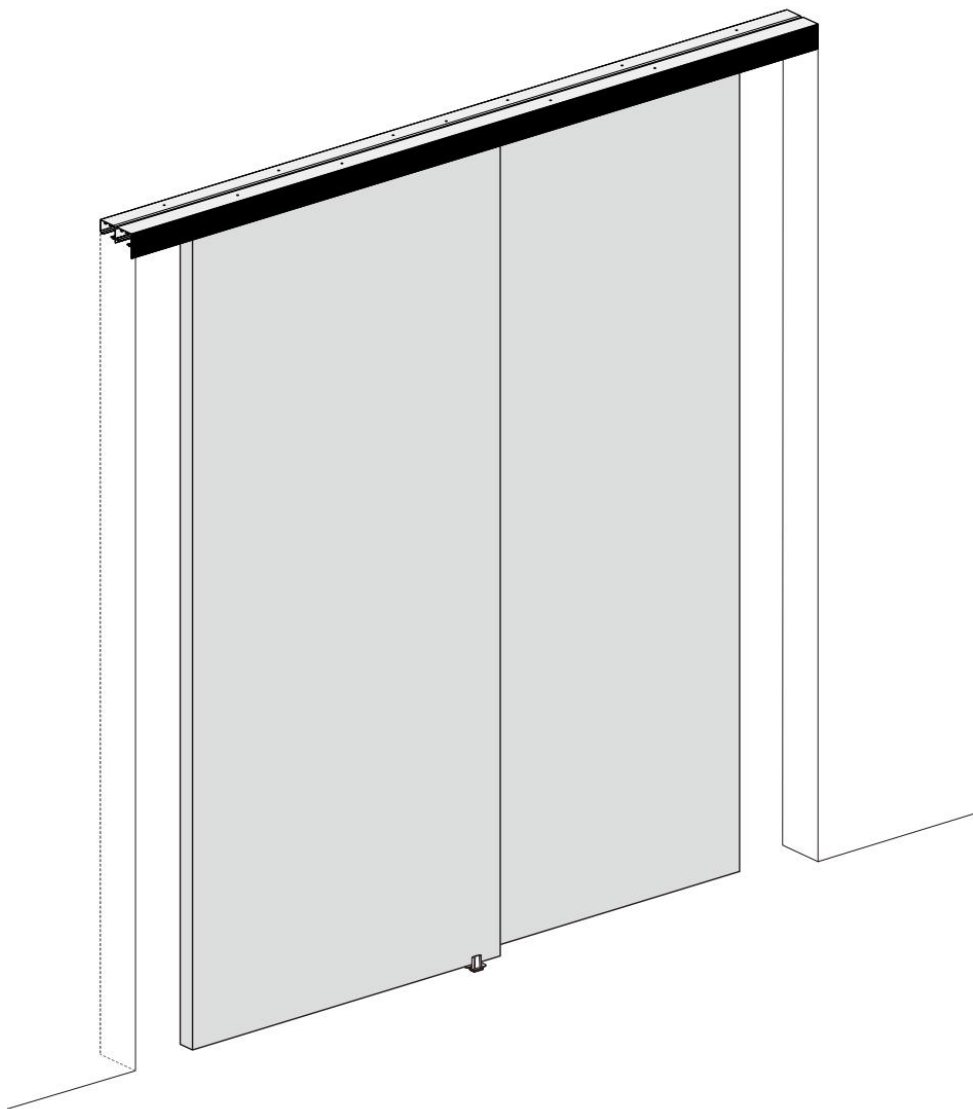

Componentenlijst

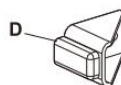
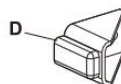
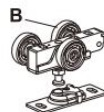
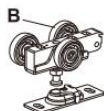
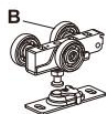
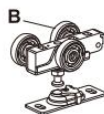
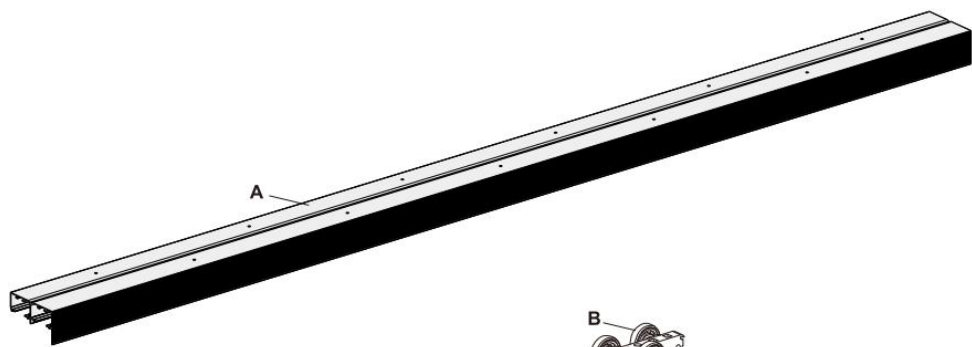

Technische parameters en onderdelenlijst

Technische parameters	
Naam	Schuifdeurrail
Model	XC40B-5FT
Spoorclassificatie	Dubbel spoor
Spoorafmetingen	60 inch (1524 mm)
Zacht sluiten	Nee
Laadvermogen	300 lbs (136 kg)
Uiterlijk Kleur	Zwart

(XC40B-5FT) Onderdelenlijst			
Naam	Specificatie	Aantal (stuks)	Notities
Spoor	/	1	Dubbele
Gebruikershandleiding	/	1	
Hanger (wielmontage)	/	4	Zonder softclose
Stop	/	2	
Vloergids	/	1	
Moersleutel	/	1	
Schroeven voor wandmontage	/	10	9 voor daadwerkelijk gebruik, 1 extra van de fabrikant
Schroeven voor het ophangwiel	/	9	8 voor daadwerkelijk gebruik, 1 extra van de fabrikant
Schroeven voor anti-sway-apparaat	/	3	2 voor daadwerkelijk gebruik, 1 extra van de fabrikant
Stopschroef	/	7	6 voor daadwerkelijk gebruik, 1 extra van de fabrikant

Pre-installatie

TOOLS REQUIRED

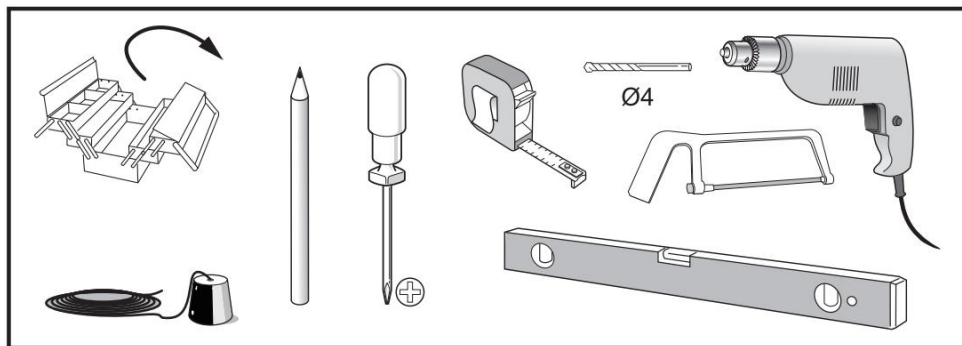

HARDWARE INCLUDED

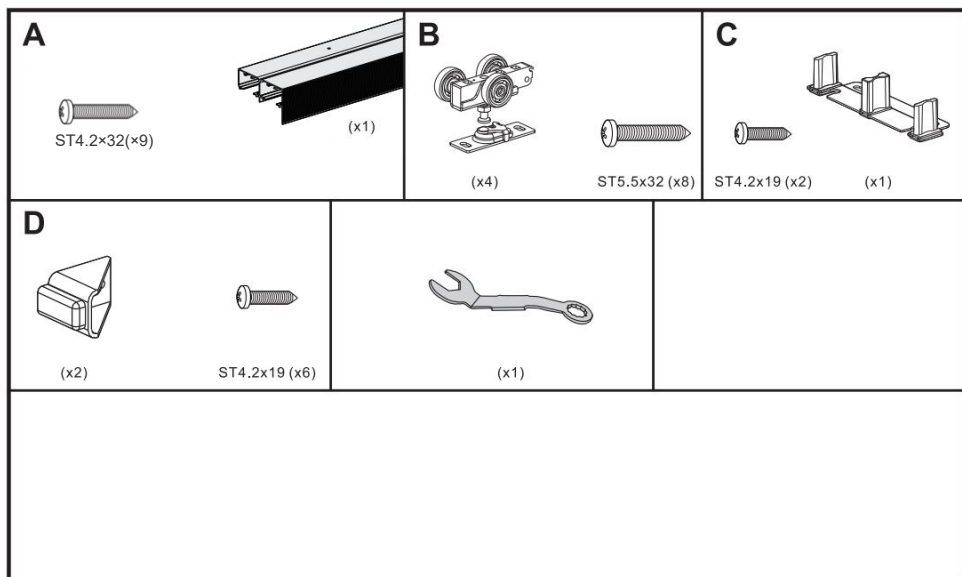

Installatie

Fits 35 and 45mm thick wood door
each door max weight 150lbs

2XDOOR

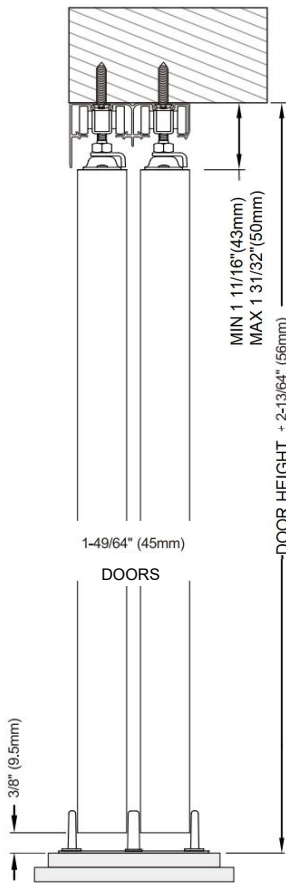
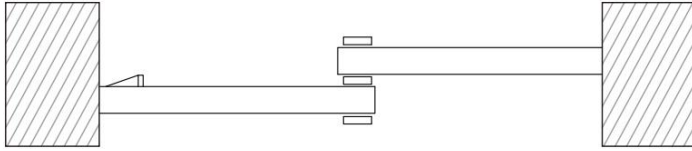

Installatie

1

A

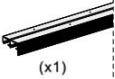

(x1)

ST4.2x32

B



(x4)

Install Track

Cut track to fit opening. Insert hangers into track and alternate wheel positions to distribute weight evenly. Mount track to header with screws.

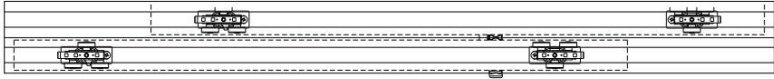

2

B



(x4)

ST5.5x32 (x8)

Install Door Plates

Attach door plates on top of door 2-3/4" (70mm) from each edge with lock tabs on the same side.

45mm DOOR

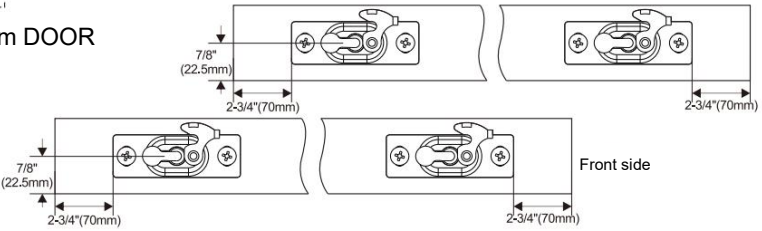

35mm DOOR

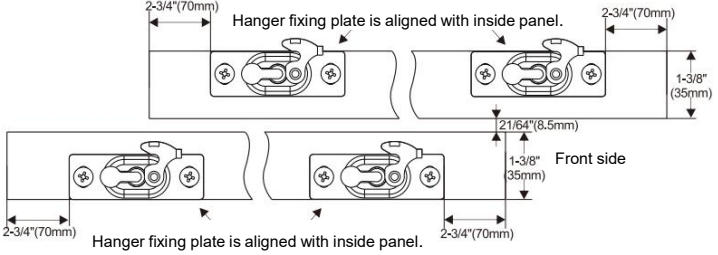

Installatie

3

B



Hang Doors on Track

Hang Door on front leg of track first, Mount door by locating door plate under adjusting bolt of hanger and lock into place. Check for smooth travel. Repeat with rear door.

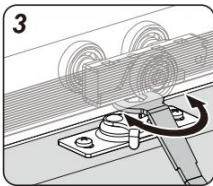
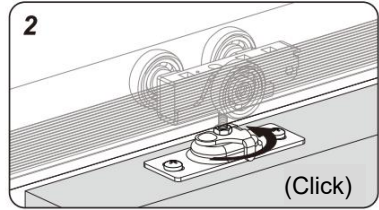
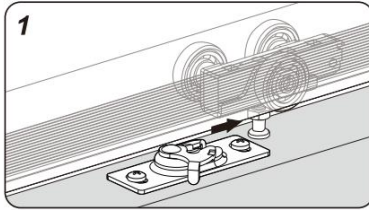

Use spanner to adjust door height

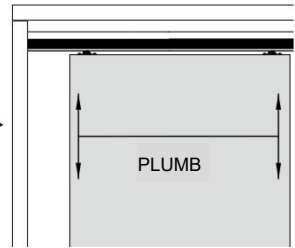
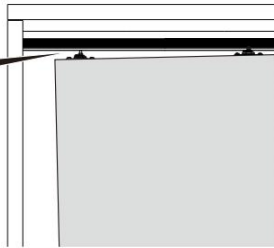

4

C

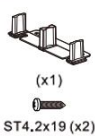

Install Floor Guide

Slide both doors to side jamb. Place guide between doors and position to plumb, then fasten to floor with screws.

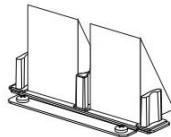
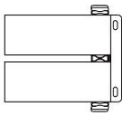

(default for 45 thick door)

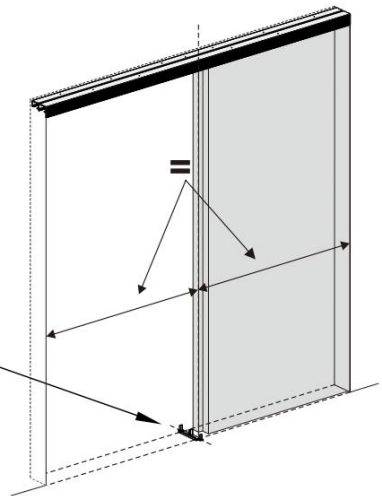

Installatie

4

NOTE: Floor guide installation instruction for 35mm thick wood door :

1

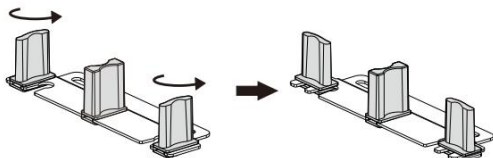

2

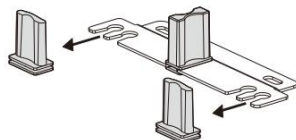

3

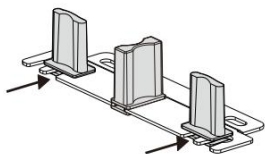

4

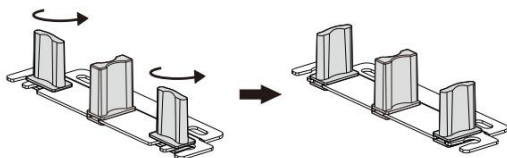

5

Door Adjustment

Use spanner to adjust door height through adjusting nut of hanger. Doors should plumb with jambs.

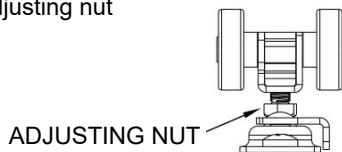

Installatie

6

D



(x2)



ST4.2x19 (x6)

Install Door Stop

Attach door stop on the back of front door, 1-1/2"(38mm) from door edge, 1/2"(13mm) from top (Hollow Core doors) or 40"(100mm) from bottom (Solid Core doors). Note: if other than pull is used, adjust location of stop to allow for access to rear door pull.

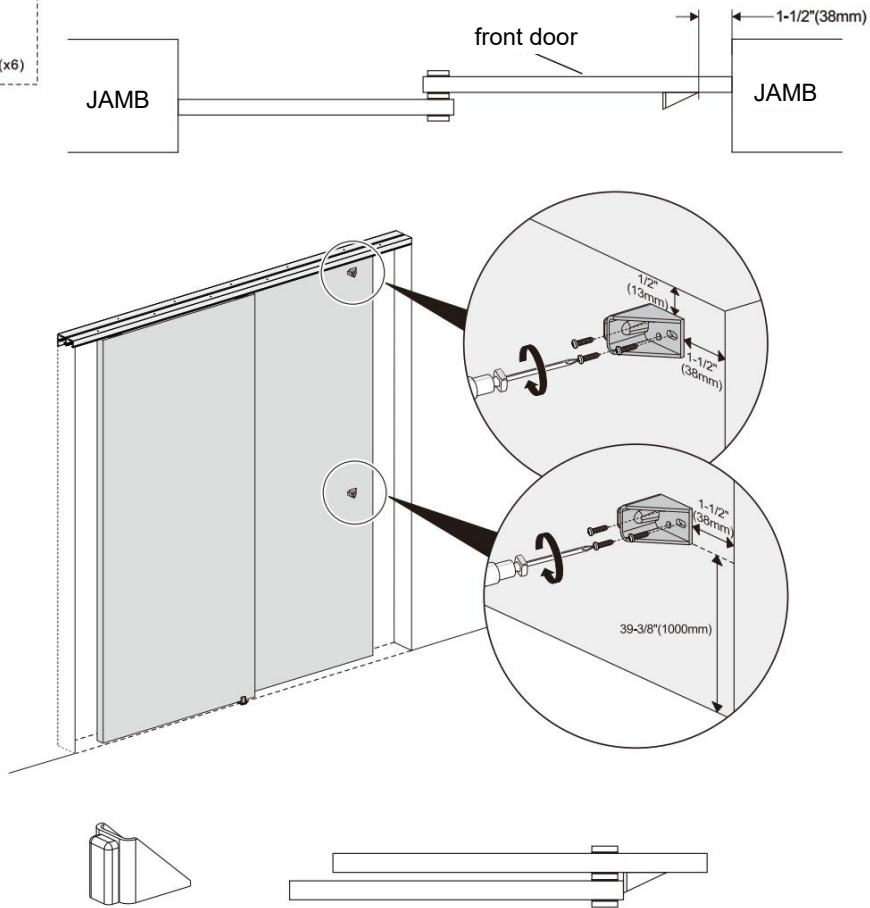

MAINTENANCE

4. Vermijd langdurige blootstelling aan de zon om veroudering te voorkomen.

Fabrikant: Shanghaimuxinmuyeyouxiangongsi

Adres: Shuangchenglu 803nong11hao1602A-1609shi, baoshanqu, shanghai 200000 CN.

Geïmporteerd naar AUS: SIHAO PTY LTD. 1 ROKEVA
STREETEASTWOOD
NSW 2122 Australië

Geïmporteerd naar de VS: Sanven Technology Ltd. Suite 250, 9166
Anaheim
Plaats, Rancho Cucamonga, CA 91730

UK	REP	YH CONSULTING LIMITED. C/O YH Consulting Limited Office 147, Centurion House, London Road, Staines-upon-Thames, Surrey, TW18 4AX
-----------	------------	--

EC	REP	E-CrossStu GmbH Mainzer Landstr.69, 60329 Frankfurt am Main.
-----------	------------	--



VEVOR

Upgrade · The Home Creator Way

Rail de porte coulissante

MODÈLE: XC40 B - 1,5 M



Vidéo d'installation

MODÈLE: XC40B-5FT

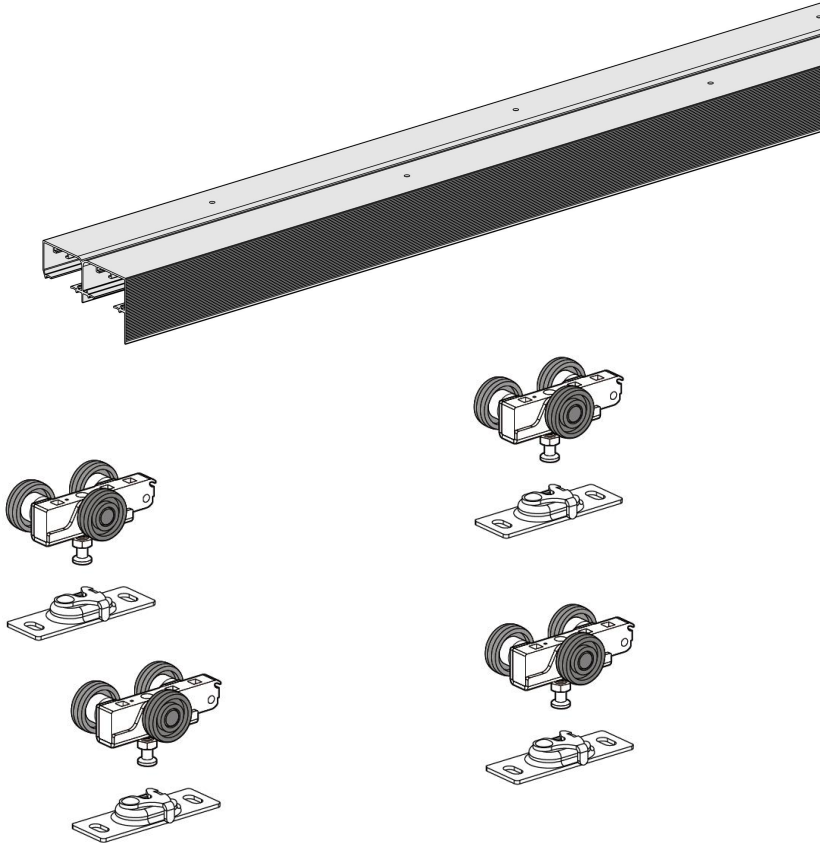

Voici le mode d'emploi original. Veuillez lire attentivement toutes les instructions du manuel avant utilisation. VEVOR se réserve le droit d'interpréter ce manuel à sa guise. L'apparence du produit que vous recevrez peut différer. Nous vous prions de nous excuser si nous ne vous informons pas des mises à jour techniques ou logicielles concernant notre produit.

INSTRUCTIONS

Merci beaucoup d'avoir choisi ce rail de porte coulissante .

Veuillez lire attentivement toutes les instructions avant utilisation. Ces informations vous aideront à obtenir les meilleurs résultats possibles.

Les produits présentés dans ce catalogue peuvent avoir une couleur différente de celle du produit réel .

CONSERVEZ CES INSTRUCTIONS

AVERTISSEMENT:

Respectez les règles de santé et de sécurité, les réglementations des autorités locales et les pratiques générales d'atelier.

Les réglementations sont respectées lors de l'utilisation des outils.

* N'utilisez PAS d'outils endommagés.

* Maintenir les outils en bon état et propres pour une performance optimale et en toute sécurité.

* Portez des vêtements adaptés pour éviter d'accrocher le tissu. Ne portez pas de bijoux amples et attachez vos cheveux longs.

* Indiquez tous les outils et pièces utilisés.

* Si vous travaillez à l'extérieur du véhicule, assurez-vous que le lieu de travail est sûr et stable.

* N'utilisez pas ces outils si vous êtes fatigué ou sous l'influence de l'alcool, de drogues ou de médicaments intoxicants.

* **AVERTISSEMENT CONCERNANT LA SÉCURITÉ PERSONNELLE !**

Portez toujours un équipement de protection individuelle.

* **ÉQUIPEMENT DE PROTECTION INDIVIDUELLE**

1. Portez toujours des lunettes de sécurité à impact offrant une protection frontale et latérale des yeux. L'équipement de protection oculaire doit être conforme aux normes CSA Z94.3-07 ou ANSI Z87.1 selon le type de travail effectué.

2. Portez des gants de protection adaptés aux matériaux utilisés ou permettant de réduire les effets des vibrations des outils.



**Conforme aux exigences réglementaires européennes pertinentes
(CPR)305/2011 .**

Manuel d' installation

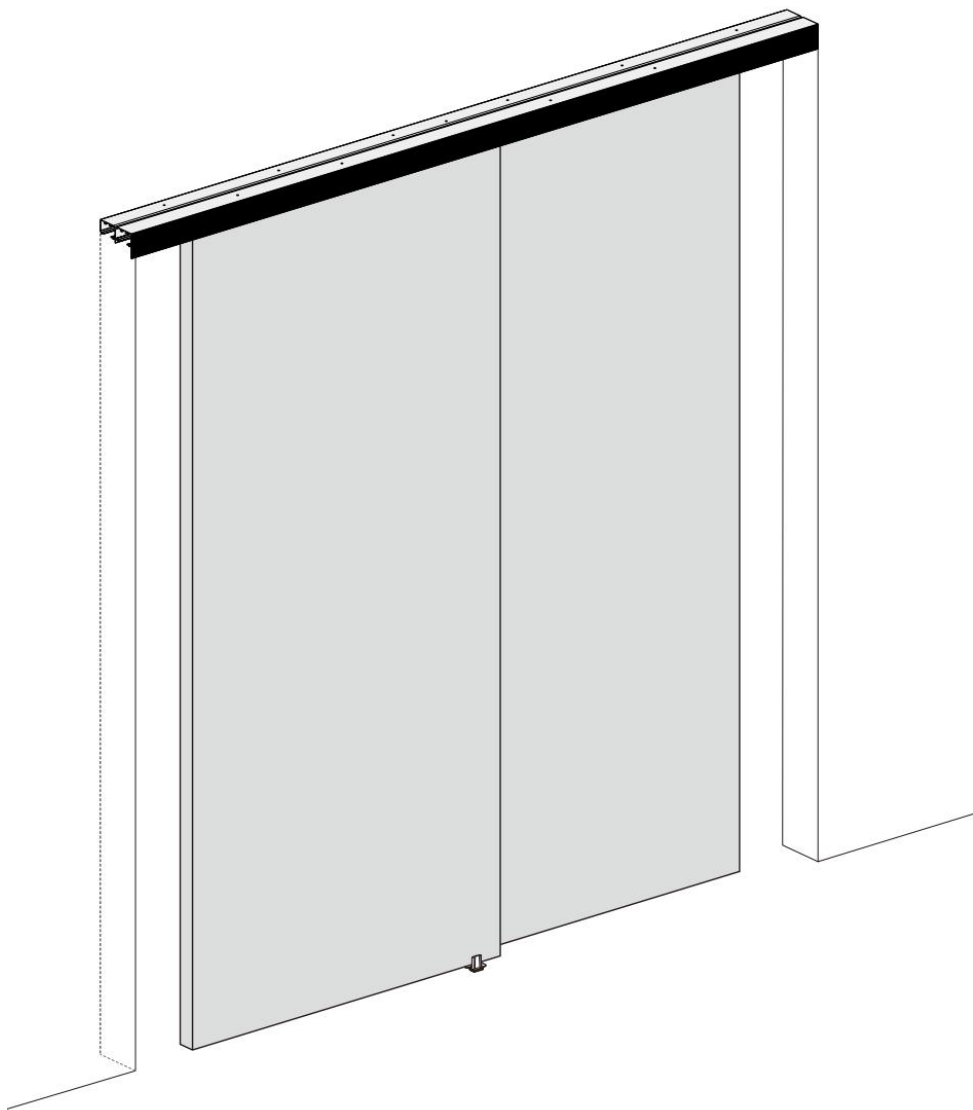

Liste des composants

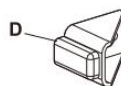
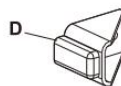
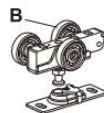
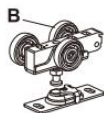
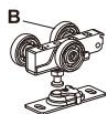
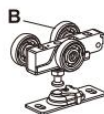
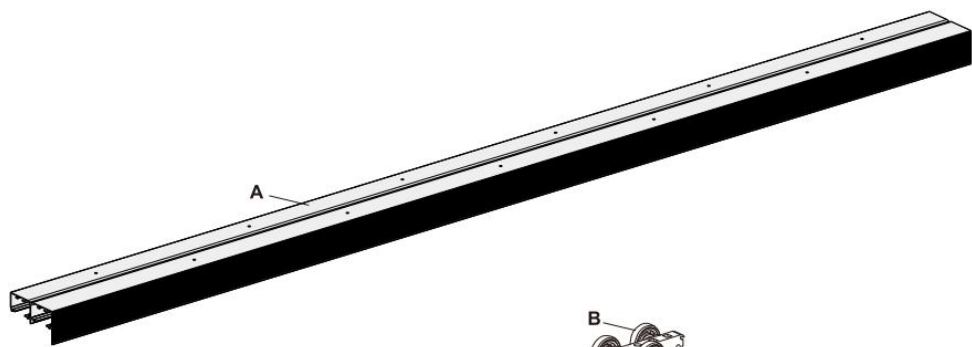

Paramètres techniques et liste des pièces

Paramètres techniques	
Nom	Rail de porte coulissante
Modèle	XC40B-5FT
Classification des pistes	Double voie
Dimensions de la voie	60 " (1524 mm)
Fermeture douce	Non
Capacité de charge	300 LBS (136 kg)
Apparence Couleur	Noir

Liste des pièces (XC40B-5FT)			
Nom	Spécification	Qté (pièces)	Notes
Piste	/	1	Double
Manuel de l' utilisateur	/	1	
Support (Ensemble de roue)	/	4	Sans fermeture douce
Bouchon	/	2	
Guide des étages	/	1	
Clé	/	1	
Vis de fixation murale	/	10	9 pour une utilisation réelle, 1 supplémentaire fournie par le fabricant
Vis de roue de suspension	/	9	8 pour une utilisation réelle, 1 supplémentaire fournie par le fabricant
Vis du dispositif anti-balancement	/	3	2 pour une utilisation réelle, 1 supplémentaire fournie par le fabricant
Vis d'arrêt	/	7	6 pour une utilisation réelle, 1 supplémentaire fournie par le fabricant

Pré-installation

TOOLS REQUIRED

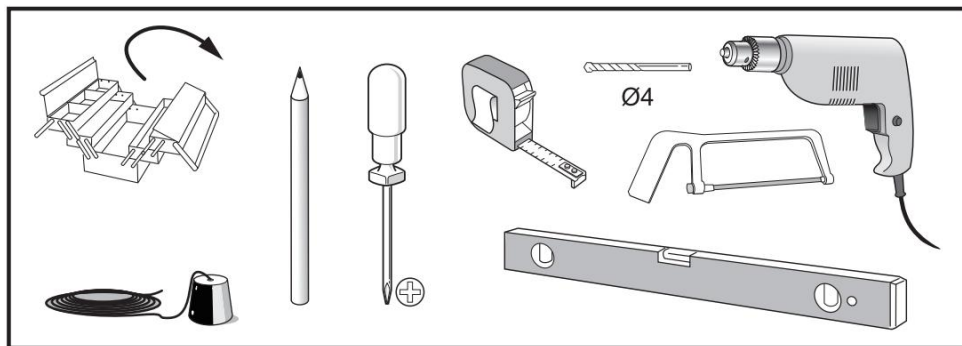

HARDWARE INCLUDED

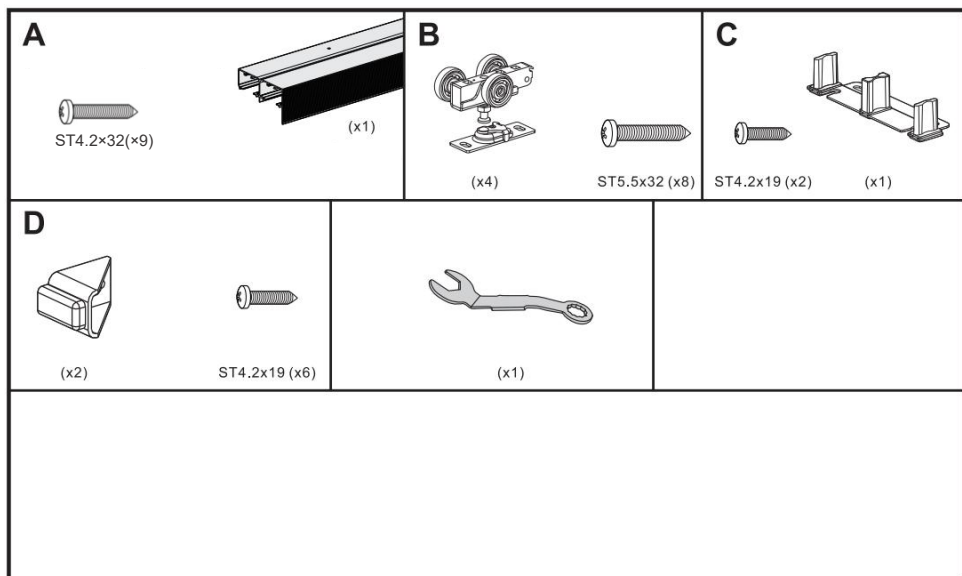

Installation

Fits 35 and 45mm thick wood door
each door max weight 150lbs

2XDOOR

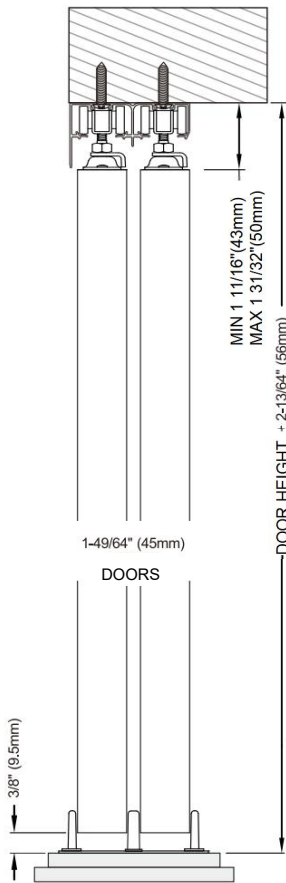
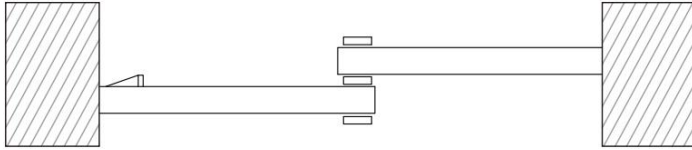

Installation

1

A

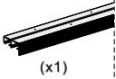

Install Track

Cut track to fit opening. Insert hangers into track and alternate wheel positions to distribute weight evenly. Mount track to header with screws.

ST4.2x32

B



2

B



Install Door Plates

Attach door plates on top of door 2-3/4" (70mm) from each edge with lock tabs on the same side.

ST5.5x32 (x8)

45mm DOOR

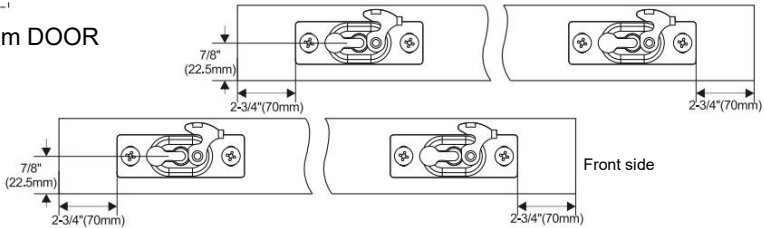

35mm DOOR

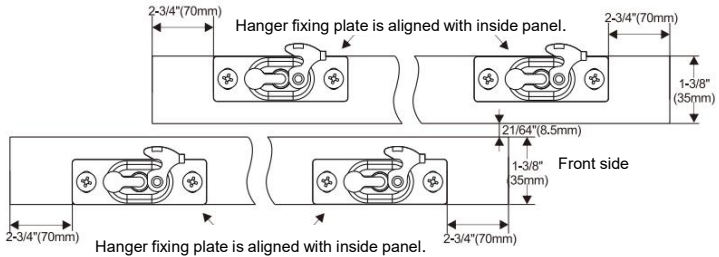

Installation

3

B



Hang Doors on Track

Hang Door on front leg of track first, Mount door by locating door plate under adjusting bolt of hanger and lock into place. Check for smooth travel. Repeat with rear door.

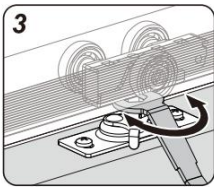
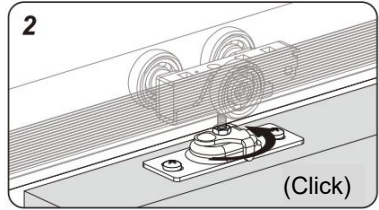
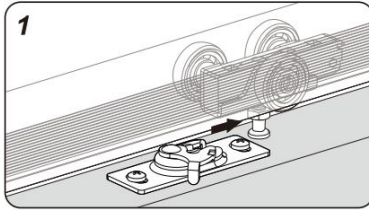

Use spanner to adjust door height

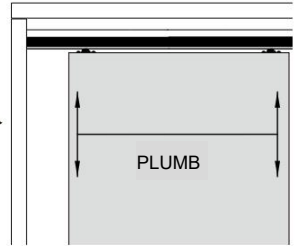
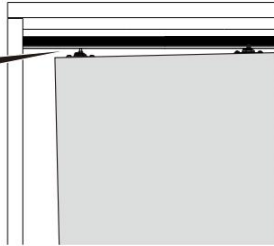

4

C

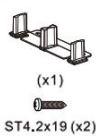

Install Floor Guide

Slide both doors to side jamb. Place guide between doors and position to plumb, then fasten to floor with screws.

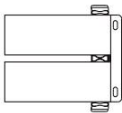

(default for 45 thick door)

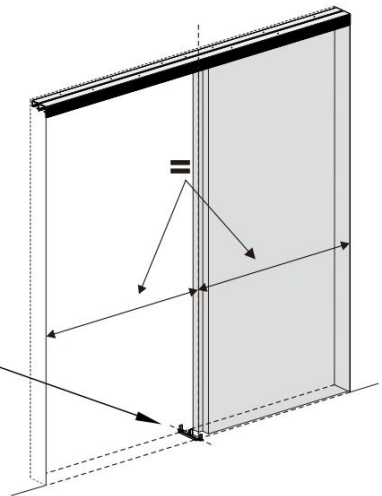

Installation

4

NOTE: Floor guide installation instruction for 35mm thick wood door :

1

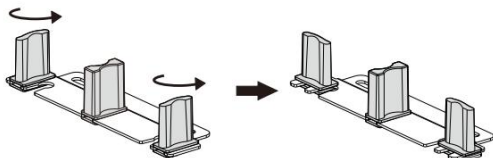

2

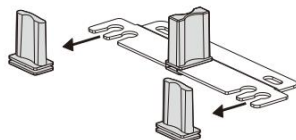

3

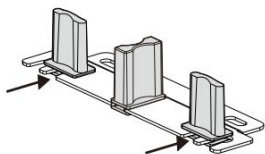

4

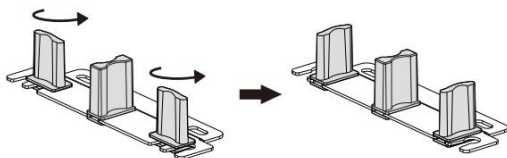

5

Door Adjustment

Use spanner to adjust door height through adjusting nut of hanger. Doors should plumb with jambs.

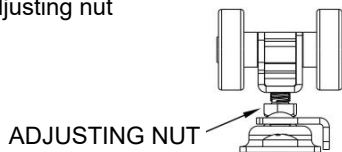

Installation

6

D



(x2)



ST4.2x19 (x6)

Install Door Stop

Attach door stop on the back of front door, 1-1/2"(38mm) from door edge, 1/2"(13mm) from top (Hollow Core doors) or 40"(100mm) from bottom (Solid Core doors). Note: if other than pull is used, adjust location of stop to allow for access to rear door pull.

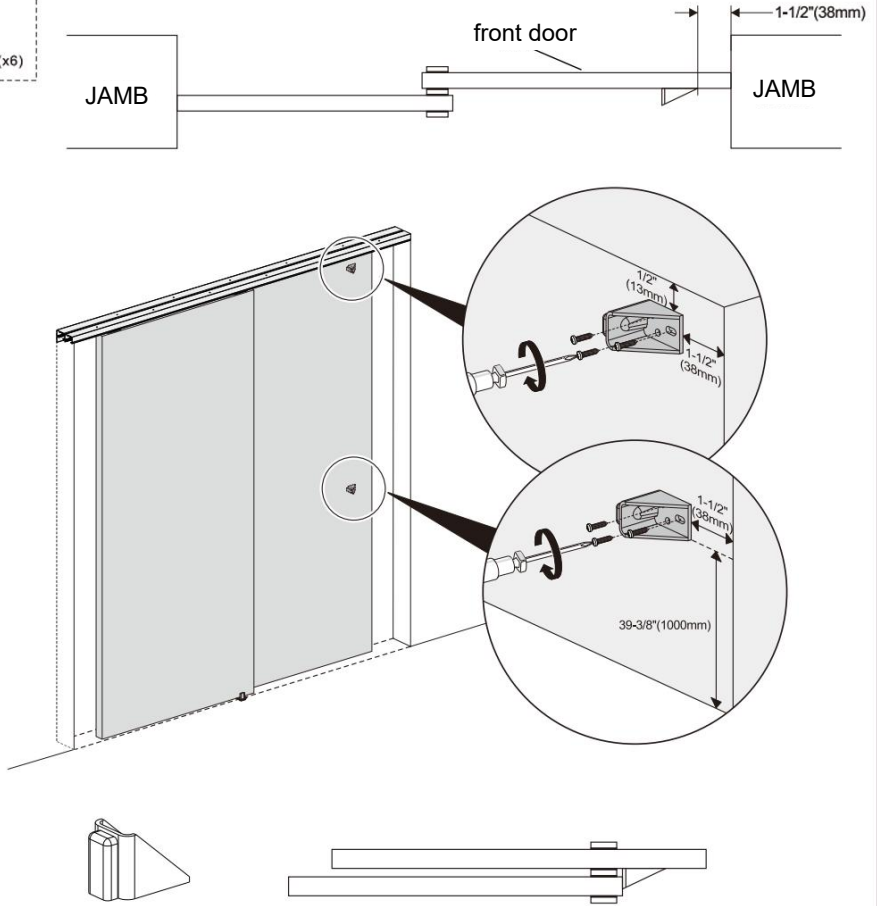

MAINTENANCE

5. Évitez une exposition prolongée au soleil pour éviter le vieillissement.

Fabricant : Shanghai muxinmuyeyouxiangongsi

Adresse : Shuangchenglu 803nong11hao1602A-1609shi, baoshanqu, Shanghai 200000 CN.

Importé en Australie : SIHAO PTY LTD. 1 ROKEVA
STREETEASTWOOD
NSW 2122 Australie

Importé aux États-Unis : Sanven Technology Ltd., Suite 250, 9166
Anaheim
Rancho Cucamonga, CA 91730

UK	REP	YH CONSULTING LIMITED. C/O YH Consulting Limited Office 147, Centurion House, London Road, Staines-upon-Thames, Surrey, TW18 4AX
-----------	------------	--

EC	REP	E-CrossStu GmbH Mainzer Landstr.69, 60329 Frankfurt am Main.
-----------	------------	--



VEVOR

Upgrade · The Home Creator Way

Schiebetürschiene

MODELL: XC40 B - 5 FUß



Installationsvideo

MODELL: XC40B-5FT

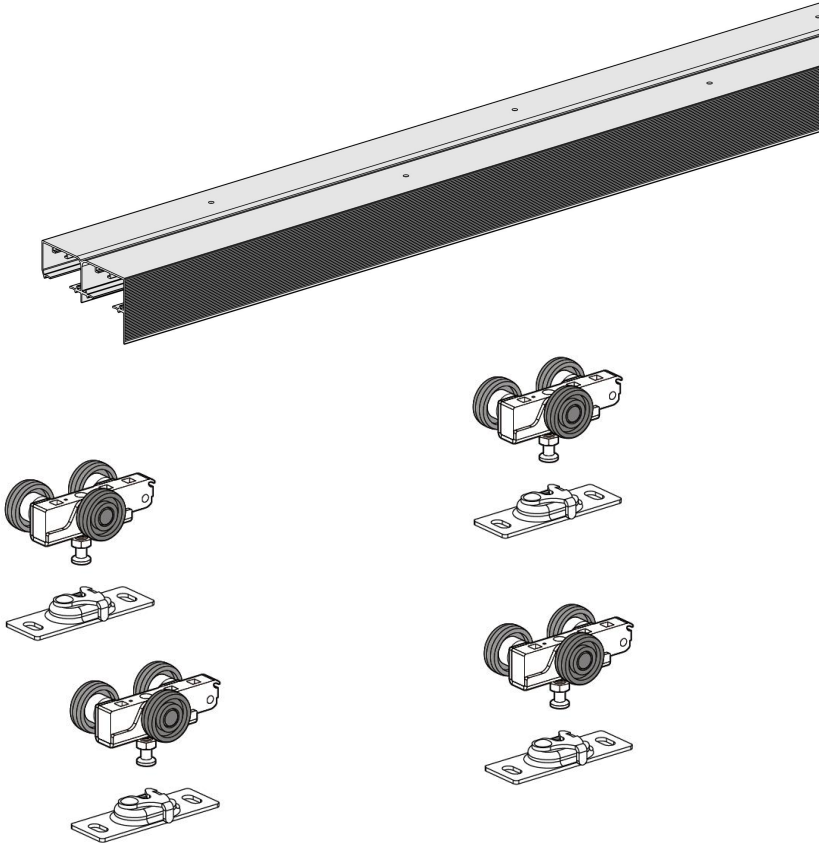

Dies ist die Originalanleitung. Bitte lesen Sie die gesamte Bedienungsanleitung vor der Inbetriebnahme sorgfältig durch. VEVOR behält sich die Auslegung der Bedienungsanleitung vor. Das Aussehen des Produkts kann von dem gelieferten Produkt abweichen. Wir bitten um Verständnis, dass wir Sie nicht erneut über etwaige Technologie- oder Software-Updates informieren werden .

INSTRUCTIONS

Vielen Dank, dass Sie sich für diese Schiebetürschiene entschieden haben .

Bitte lesen Sie die gesamte Gebrauchsanweisung vor der Anwendung. Die Informationen helfen Ihnen, optimale Ergebnisse zu erzielen.

Die in diesem Katalog abgebildeten Produkte können farblich vom tatsächlichen Artikel abweichen .

BEWAHREN SIE DIESE ANWEISUNGEN AUF

WARNUNG:

Gewährleistung von Gesundheit und Sicherheit, Einhaltung der Vorschriften der lokalen Behörden und allgemeine Werkstattpraxis
Bei der Verwendung von Werkzeugen werden die Vorschriften eingehalten.

- * Werkzeuge dürfen nicht verwendet werden, wenn sie beschädigt sind.
- * Für optimale und sichere Leistung müssen die Werkzeuge stets in gutem und sauberem Zustand sein.
- * Tragen Sie geeignete Kleidung, um ein Hängenbleiben zu vermeiden.
Tragen Sie keinen losen Schmuck und binden Sie lange Haare zusammen.
- * Alle verwendeten Werkzeuge und Teile müssen dokumentiert werden.
- * Wenn Sie außerhalb des Fahrzeugs arbeiten, stellen Sie sicher, dass der Arbeitsplatz sicher und stabil ist.
- * **Verwenden Sie** diese Werkzeuge nicht , wenn Sie müde sind oder unter dem Einfluss von Alkohol, Drogen oder berauschenden Medikamenten stehen.

*** WICHTIGER HINWEIS ZUR PERSÖNLICHEN SICHERHEIT!**

Tragen Sie stets persönliche Schutzausrüstung.

*** PERSÖNLICHE SCHUTZAUSRÜSTUNG**

1. Tragen Sie stets eine Schutzbrille, die Ihre Augen von vorne und von der Seite schützt. Die Augenschutzausrüstung muss je nach Art der ausgeführten Arbeit den Normen CSA Z94.3-07 oder ANSI Z87.1 entsprechen.

2. Tragen Sie Handschuhe, die je nach Arbeitsmaterial Schutz bieten oder die Auswirkungen von Werkzeugvibrationen reduzieren.



Entspricht den einschlägigen Anforderungen der EU-Verordnung (CPR) 305/2011 .

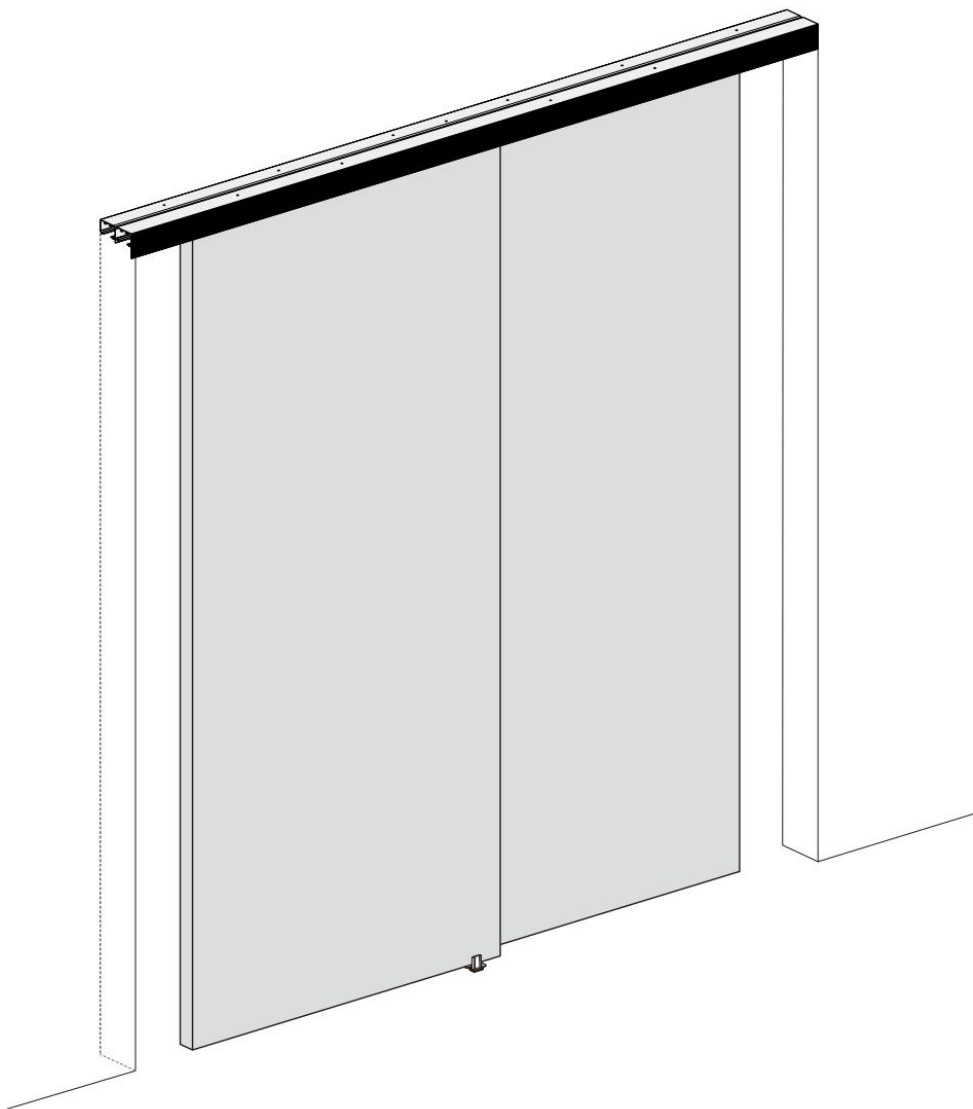

Komponentenliste

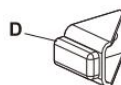
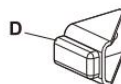
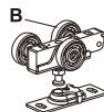
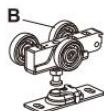
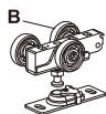
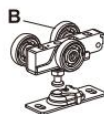
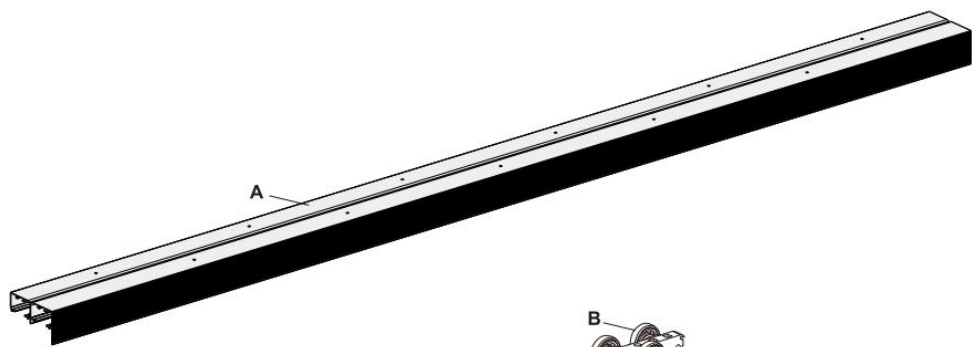

Technische Parameter und Teileliste

Technische Parameter	
Name	Schiebetürschiene
Modell	XC40B-5FT
Gleisklassifizierung	Doppelgleis
Gleisabmessungen	60 Zoll (1524 mm)
Sanftes Schließen	NEIN
Tragfähigkeit	300 Pfund (136 kg)
Aussehen Farbe	Schwarz

(XC40B-5FT) Teileliste			
Name	Spezifikation	Menge (Stück)	Anmerkungen
Schiene	/	1	Doppelt
Benutzerhandbuch	/	1	
Aufhängung (Radbaugruppe)	/	4	Ohne Soft-Close-Funktion
Stopper	/	2	
Bodenführung	/	1	
Schlüssel	/	1	
Wandbefestigungsschrauben	/	10	9 Stück für den tatsächlichen Gebrauch, 1 Stück zusätzlich vom Hersteller
Aufhängungsradsschrauben	/	9	8 Stück für den tatsächlichen Gebrauch, 1 Stück zusätzlich vom Hersteller
Schrauben der Anti-Schwingvorrichtung	/	3	2 Stück für den tatsächlichen Gebrauch, 1 zusätzliches Stück vom Hersteller
Stoppschraube	/	7	6 Stück für den tatsächlichen Gebrauch, 1 Stück zusätzlich vom Hersteller

Vorinstallation

TOOLS REQUIRED

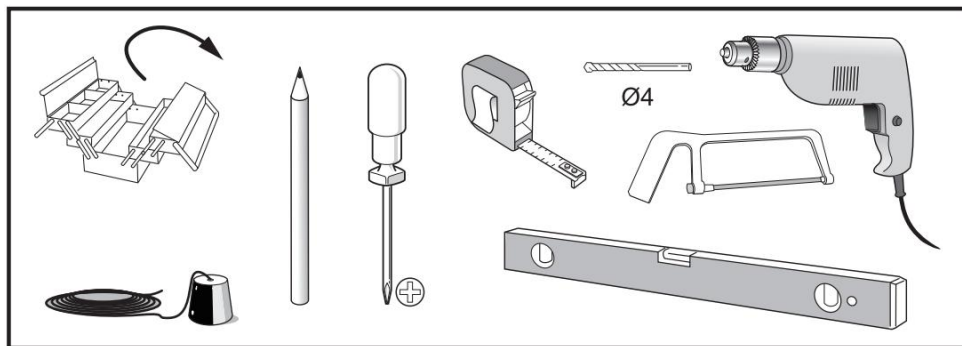

HARDWARE INCLUDED

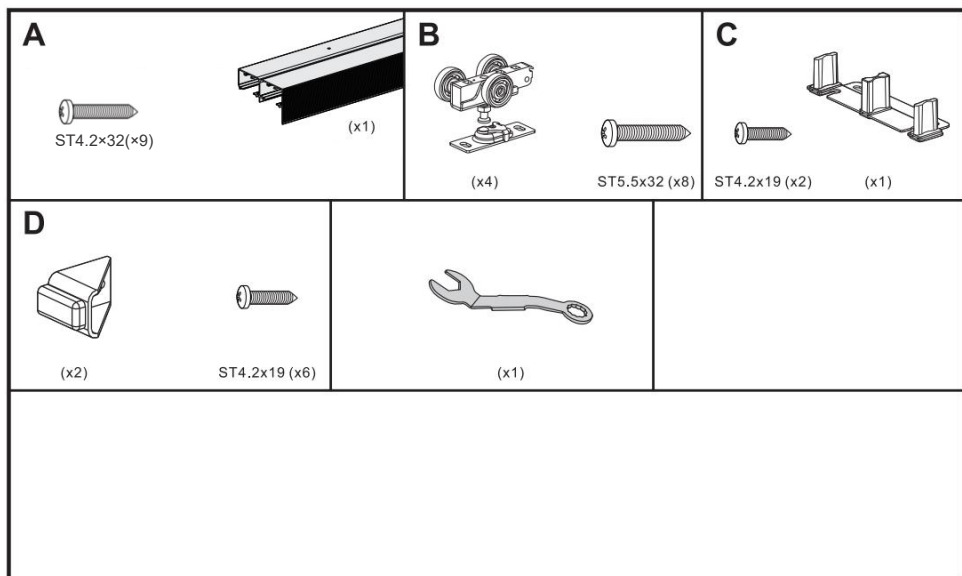

Installation

Fits 35 and 45mm thick wood door
each door max weight 150lbs

2XDOOR

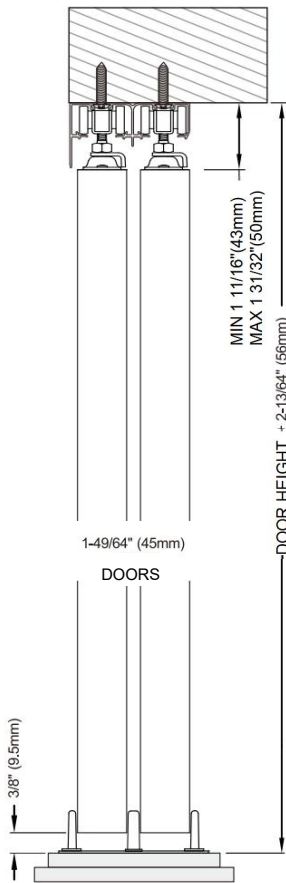
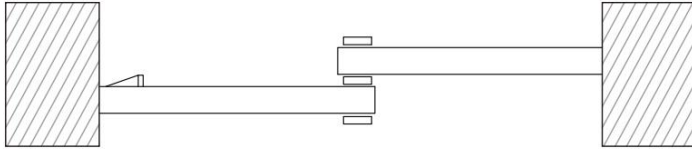

Installation

1

A

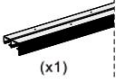

(x1)



ST4.2x32

B



(x4)

Install Track

Cut track to fit opening. Insert hangers into track and alternate wheel positions to distribute weight evenly. Mount track to header with screws.



2

B



(x4)



ST5.5x32 (x8)

Install Door Plates

Attach door plates on top of door 2-3/4" (70mm) from each edge with lock tabs on the same side.

45mm DOOR

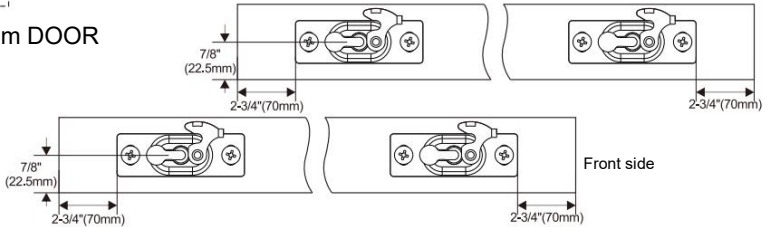

35mm DOOR

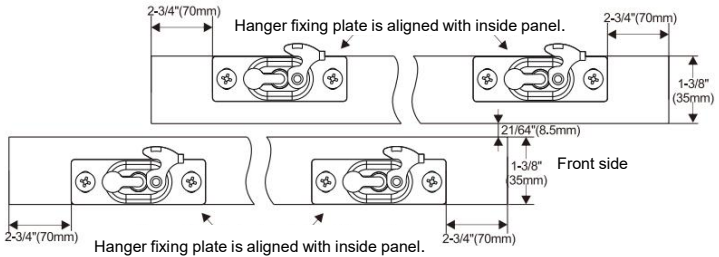

Installation

3

B



Hang Doors on Track

Hang Door on front leg of track first, Mount door by locating door plate under adjusting bolt of hanger and lock into place. Check for smooth travel. Repeat with rear door.

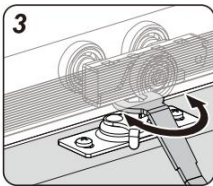
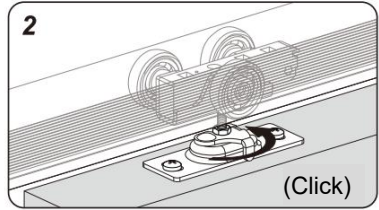
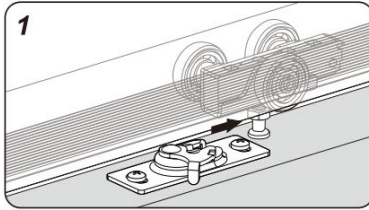

Use spanner to adjust door height

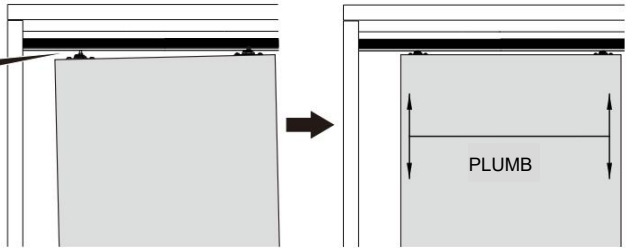

4

C

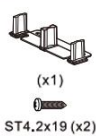

Install Floor Guide

Slide both doors to side jamb. Place guide between doors and position to plumb, then fasten to floor with screws.

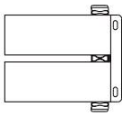

(default for 45 thick door)

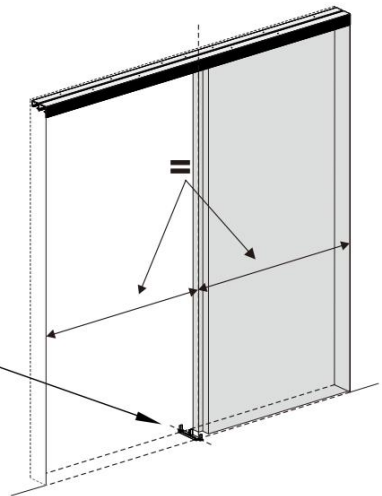

Installation

4

NOTE: Floor guide installation instruction for 35mm thick wood door :

1

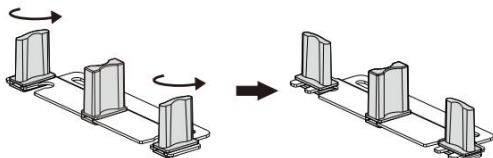

2

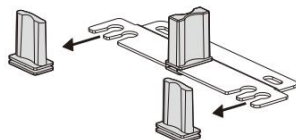

3

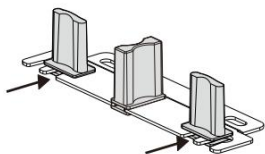

4

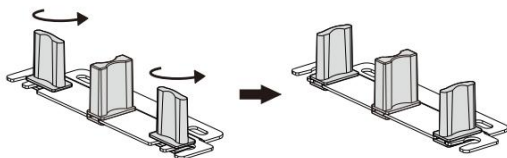

5

Door Adjustment

Use spanner to adjust door height through adjusting nut of hanger. Doors should plumb with jambs.

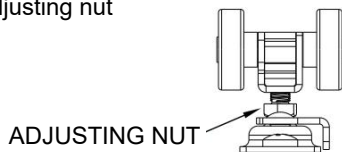

Installation

6

D



(x2)



ST4.2x19 (x6)

Install Door Stop

Attach door stop on the back of front door, 1-1/2"(38mm) from door edge, 1/2"(13mm) from top (Hollow Core doors) or 40"(100mm) from bottom (Solid Core doors). Note: if other than pull is used, adjust location of stop to allow for access to rear door pull.

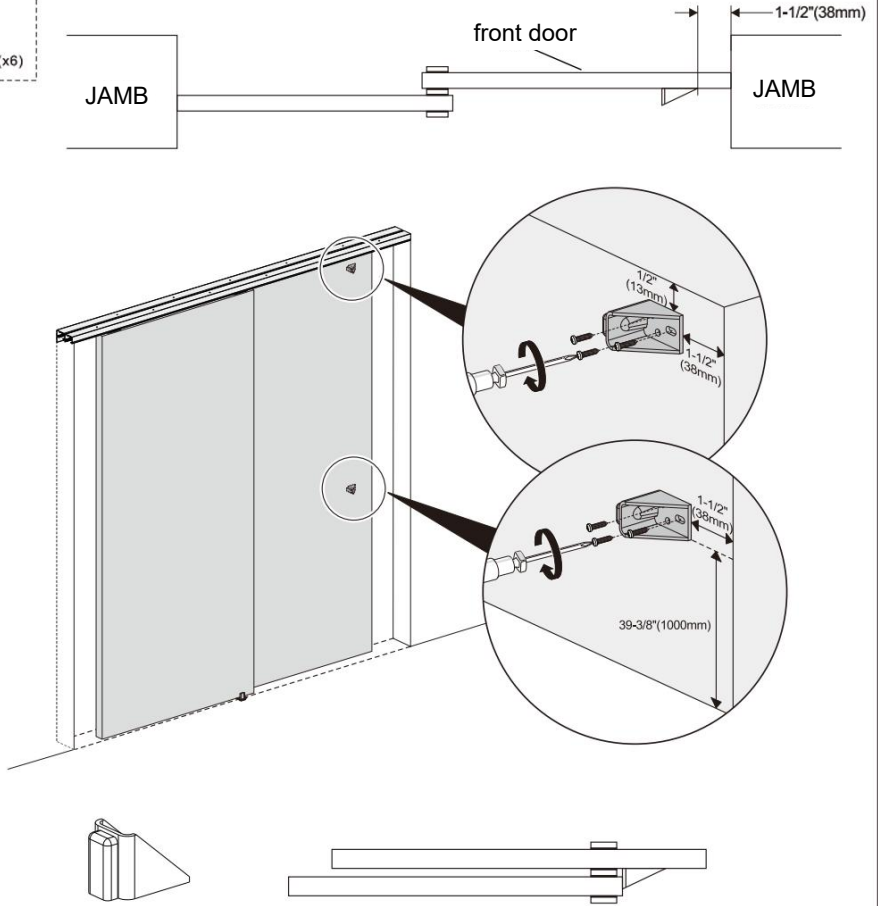

MAINTENANCE

vermeiden.

6. Um der Hautalterung vorzubeugen, sollte man längere Sonnenexposition vermeiden.

Hersteller: Shanghaimuxinmuyeyouxiangongsi

Adresse: Shuangchenglu 803nong11hao1602A-1609shi, baoshanqu, Shanghai 200000 CN.

Importiert nach Australien: SIHAO PTY LTD. 1 ROKEVA STREET, EASTWOOD

NSW 2122 Australien

Importiert in die USA: Sanven Technology Ltd. Suite 250, 9166 Anaheim Ort, Rancho Cucamonga, CA 91730

UK	REP	YH CONSULTING LIMITED. C/O YH Consulting Limited Office 147, Centurion House, London Road, Staines-upon-Thames, Surrey, TW18 4AX
-----------	------------	--

EC	REP	E-CrossStu GmbH Mainzer Landstr.69, 60329 Frankfurt am Main.
-----------	------------	--



VEVOR

Upgrade · The Home Creator Way

Szyna do drzwi przesuwnych

MODEL: XC40 B - 5 STÓP



Film z instalacji

MODEL: XC40B-5FT

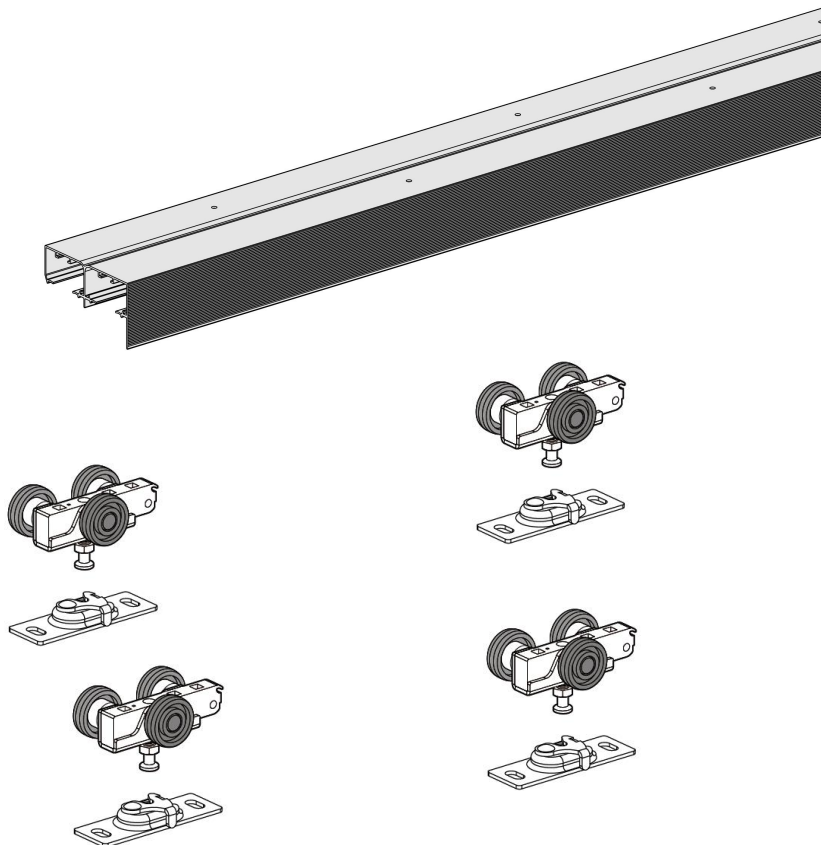

To jest oryginalna instrukcja obsługi. Przed użyciem prosimy o dokładne zapoznanie się z treścią instrukcji. Firma VEVOR zastrzega sobie prawo do jednoznacznej interpretacji niniejszej instrukcji obsługi. Wygląd produktu zależy od stanu, w jakim go otrzymali Państwo. Prosimy o wyrozumiałość, ale nie będziemy Państwa ponownie informować o aktualizacjach technologicznych lub oprogramowania naszego produktu.

INSTRUCTIONS

Dziękujemy bardzo za wybranie tego drążka do drzwi przesuwnych .

- Przed użyciem należy przeczytać całą instrukcję. Zawarte w niej informacje pomogą osiągnąć najlepsze możliwe rezultaty.

Produkty prezentowane w tym katalogu mogą różnić się kolorem od rzeczywistego produktu .

ZACHOWAJ TE INSTRUKCJE

OSTRZEŻENIE:

Zapewnienie higieny i bezpieczeństwa, władz lokalnych i ogólnych praktyk warsztatowych

przestrzegane są przepisy przy używaniu narzędzi.

* NIE używaj narzędzi, jeśli są uszkodzone.

* Utrzymuj narzędzia w dobrym i czystym stanie, aby zapewnić najlepszą i najbezpieczniejszą pracę.

* Noś odpowiednią odzież, aby uniknąć zaczepiania. Nie noś luźnej biżuterii i zwiąż długie włosy.

* Weź pod uwagę wszystkie używane narzędzia i części.

* Jeśli pracujesz poza pojazdem, upewnij się, że miejsce pracy jest bezpieczne i stabilne.

* Nie używaj tych narzędzi , jeśli jesteś zmęczony lub znajdujesz się pod wpływem alkoholu, narkotyków lub leków odurzających.

* **OSTRZEŻENIE DOTYCZĄCE BEZPIECZEŃSTWA OSOBISTEGO!**

Zawsze noś osobisty sprzęt ochronny.

* **OSOBISTY ŚRODEK OCHRONNY**

1. Zawsze noś okulary ochronne chroniące przed uderzeniami, zapewniające ochronę oczu z przodu i z boku. Sprzęt do ochrony oczu powinien być zgodny z normami CSA Z94.3-07 lub ANSI Z87.1, w zależności od rodzaju wykonywanej pracy.

2. Noś rękawice zapewniające ochronę w zależności od rodzaju materiału roboczego lub w celu zmniejszenia wpływu wibracji narzędzia.



wymogami rozporządzenia UE (CPR)305/2011 .

Instrukcja instalacji

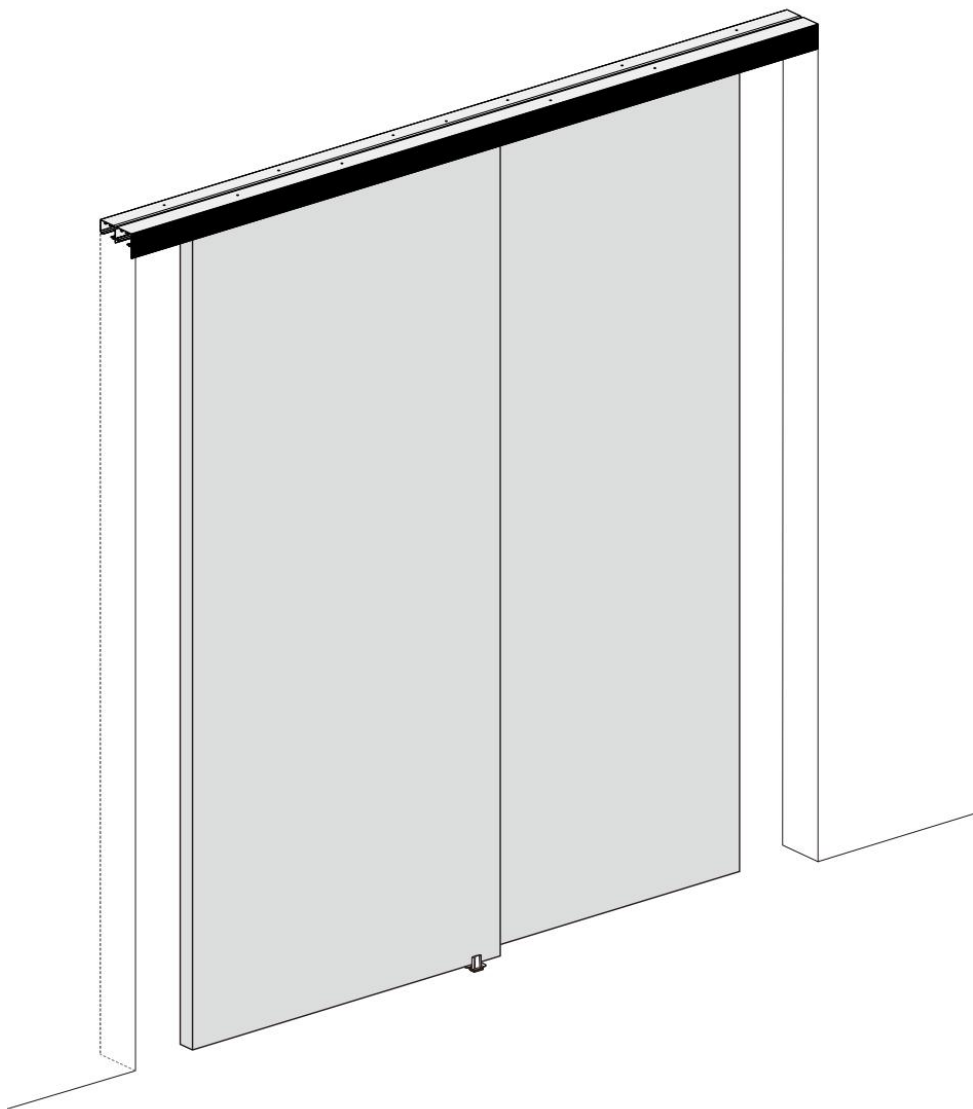

Lista komponentów

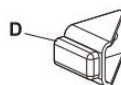
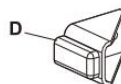
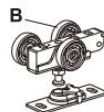
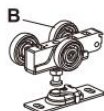
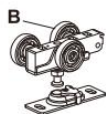
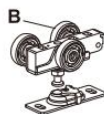
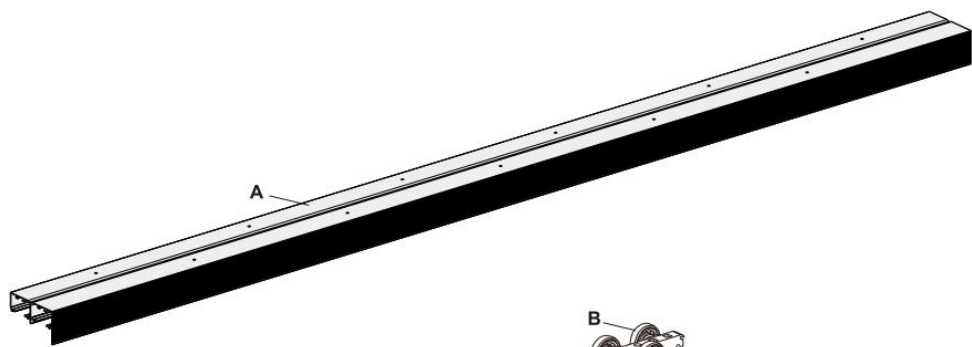

Parametry techniczne i lista części

Parametry techniczne	
Nazwa	Szyna do drzwi przesuwnych
Model	XC40B-5FT
Klasyfikacja toru	Podwójny tor
Wymiary toru	60 cali (1524 mm)
Ciche zamykanie	NIE
Nośność	300 funtów (136 kg)
Wygląd Kolor	Czarny

(XC40B-5FT) Lista części			
Nazwa	Specyfikacja	Ilość (szt.)	Notatki
Ścieżka	/	1	Podwójnie
Instrukcja obsługi	/	1	
Wieszak (zespół kół)	/	4	Bez cichego zamykania
Korek	/	2	
Przewodnik po podłodze	/	1	
Klucz	/	1	
Śruby do montażu na ścianie	/	10	9 do użytku rzeczywistego, 1 dodatkowo od producenta
Śruby do kół wieszakowych	/	9	8 do użytku rzeczywistego, 1 dodatkowy od producenta
Śruby urządzenia zapobiegającego kołysaniu	/	3	2 do użytku rzeczywistego, 1 dodatkowy od producenta
Śruba blokująca	/	7	6 do użytku rzeczywistego, 1 dodatkowy od producenta

Przed instalacją

TOOLS REQUIRED

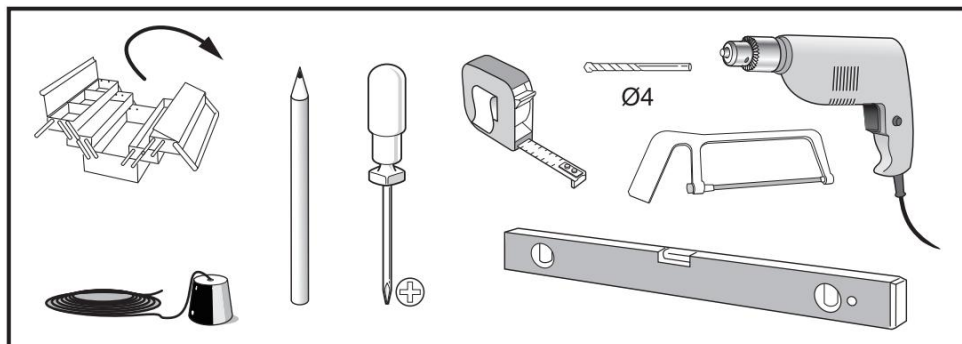

HARDWARE INCLUDED

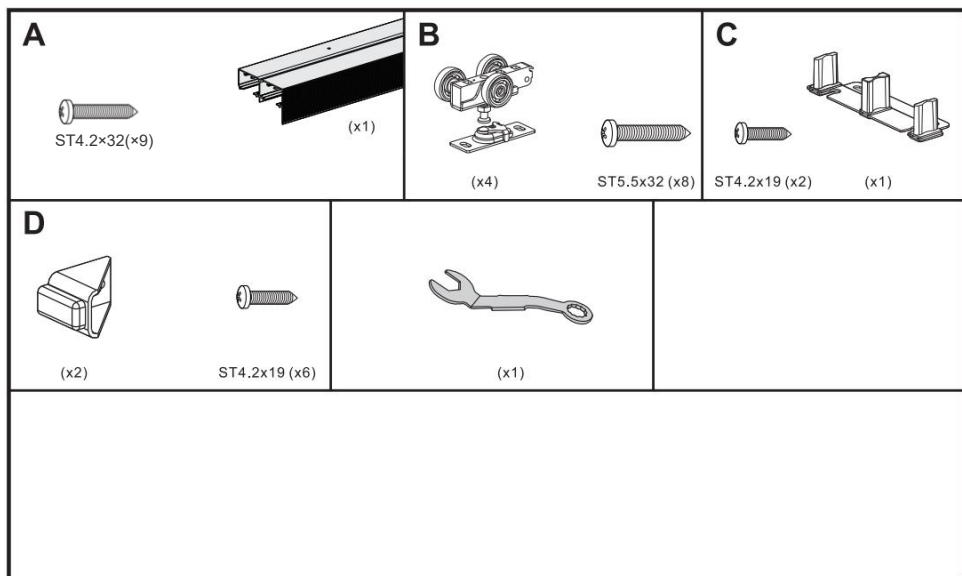

Instalacja

Fits 35 and 45mm thick wood door
each door max weight 150lbs

2XDOOR

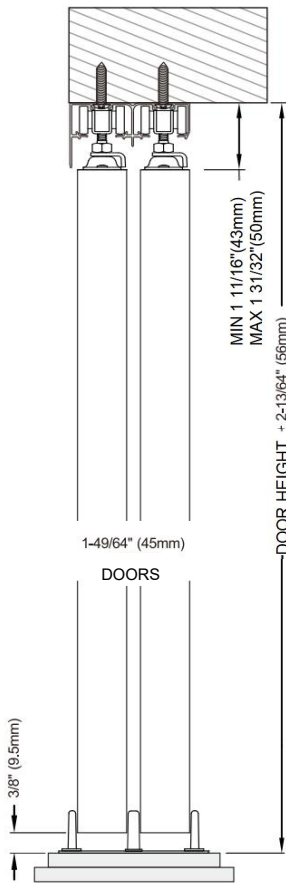
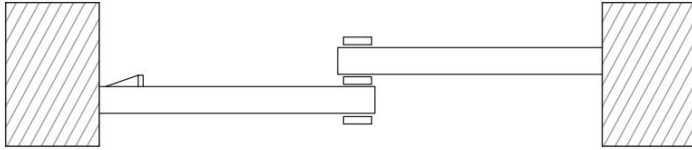

Instalacja

1

A

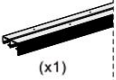

(x1)



ST4.2x32

Install Track

Cut track to fit opening. Insert hangers into track and alternate wheel positions to distribute weight evenly. Mount track to header with screws.

B



(x4)



2

B



(x4)



ST5.5x32 (x8)

Install Door Plates

Attach door plates on top of door 2-3/4" (70mm) from each edge with lock tabs on the same side.

45mm DOOR

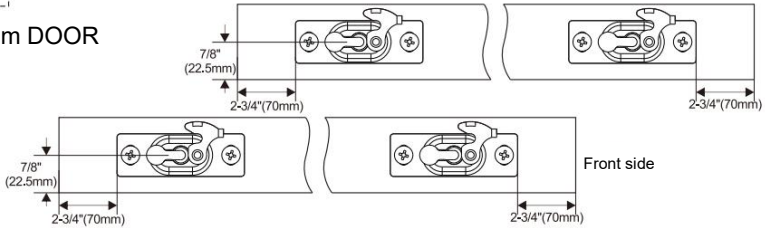

35mm DOOR

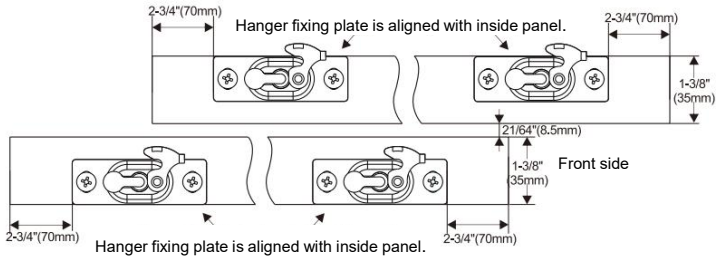

Instalacja

3

B



(x4)



ST5.5x32 (x8)

Hang Doors on Track

Hang Door on front leg of track first, Mount door by locating door plate under adjusting bolt of hanger and lock into place. Check for smooth travel. Repeat with rear door.

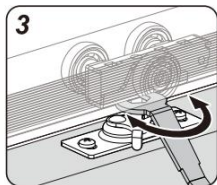
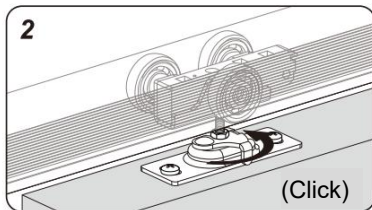
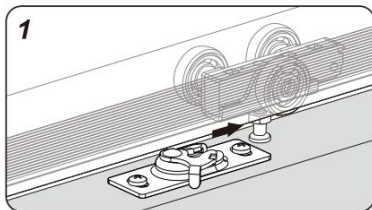

Use spanner to adjust door height

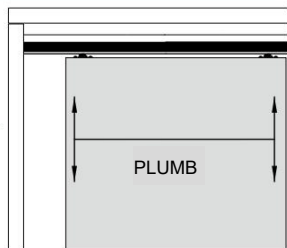
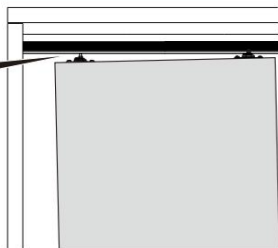

4

C



(x1)



ST4.2x19 (x2)

Install Floor Guide

Slide both doors to side jamb. Place guide between doors and position to plumb, then fasten to floor with screws.

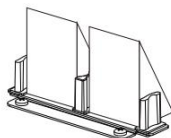
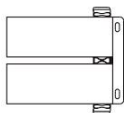

(default for 45 thick door)

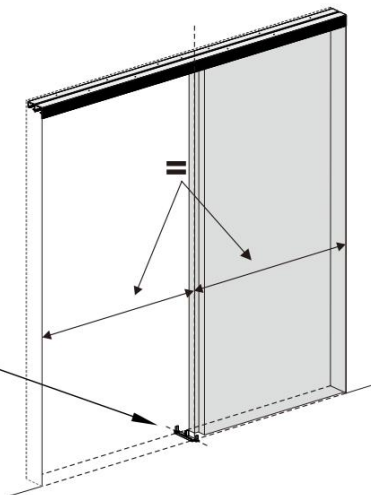

Instalacja

4

NOTE: Floor guide installation instruction for 35mm thick wood door :

1

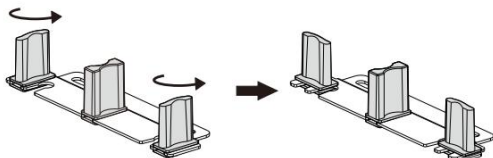

2

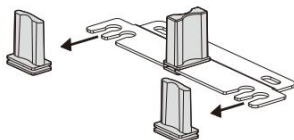

3

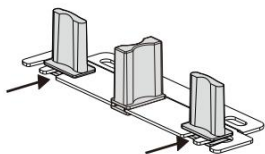

4

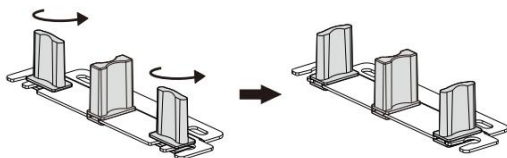

5

Door Adjustment

Use spanner to adjust door height through adjusting nut of hanger. Doors should plumb with jambs.

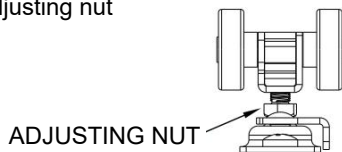

Instalacja

6

D



(x2)



ST4.2x19 (x6)

Install Door Stop

Attach door stop on the back of front door, 1-1/2"(38mm) from door edge, 1/2"(13mm) from top (Hollow Core doors) or 40"(100mm) from bottom (Solid Core doors). Note: if other than pull is used, adjust location of stop to allow for access to rear door pull.

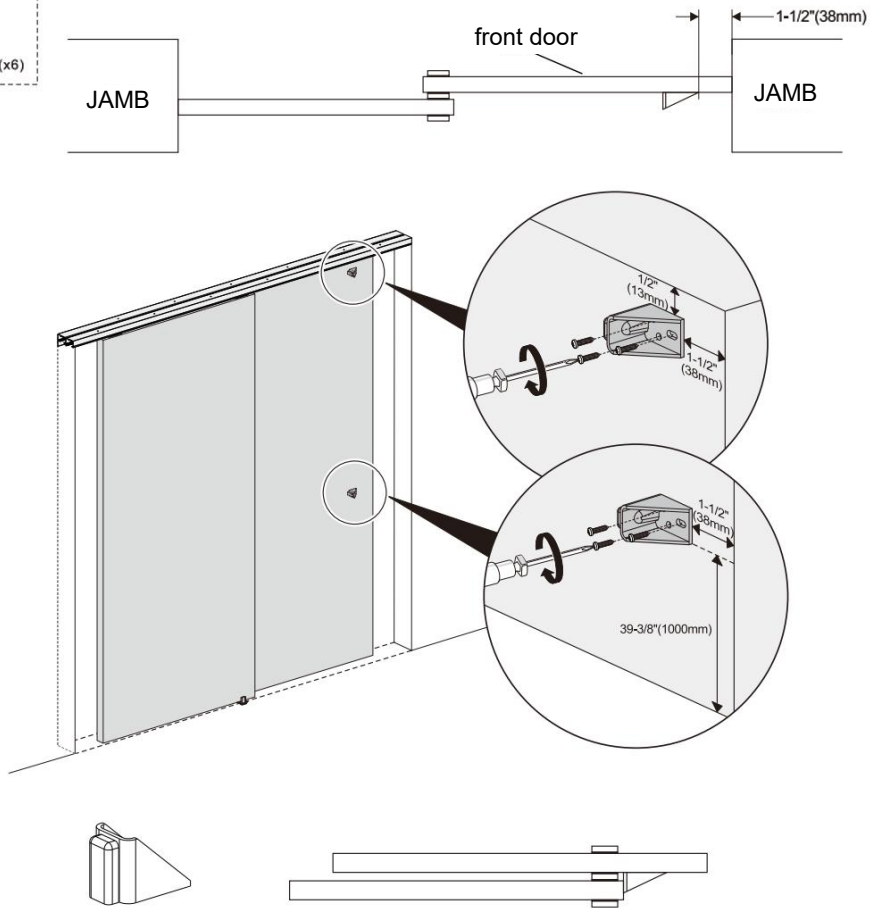

MAINTENANCE

aby zapobiec starzeniu się.

7. Aby zapobiec starzeniu się skóry, należy unikać długotrwałego wystawiania się na działanie promieni słonecznych.

Producent: Shanghaimuxinmuyeyouxiangongsi

Adres: Shuangchenglu 803nong11hao1602A-1609shi, baoshanqu, szanghaj 200000 CN.

Importowane do AUS: SIHAO PTY LTD. 1 ROKEVA
STREETEASTWOOD

NSW 2122 Australia

Importowane do USA: Sanven Technology Ltd. Suite 250, 9166 Anaheim
Miejsce, Rancho Cucamonga, CA 91730

UK	REP
-----------	------------

YH CONSULTING LIMITED. C/O YH Consulting
Limited Office 147, Centurion House, London
Road, Staines-upon-Thames, Surrey, TW18 4AX

EC	REP
-----------	------------

E-CrossStu GmbH
Mainzer Landstr.69,
60329 Frankfurt am Main.



VEVOR

Upgrade · The Home Creator Way

Binario per porta scorrevole

MODELLO: XC40 B - 5 PIEDI



Video dell'installazione

MODELLO: XC40B-5FT

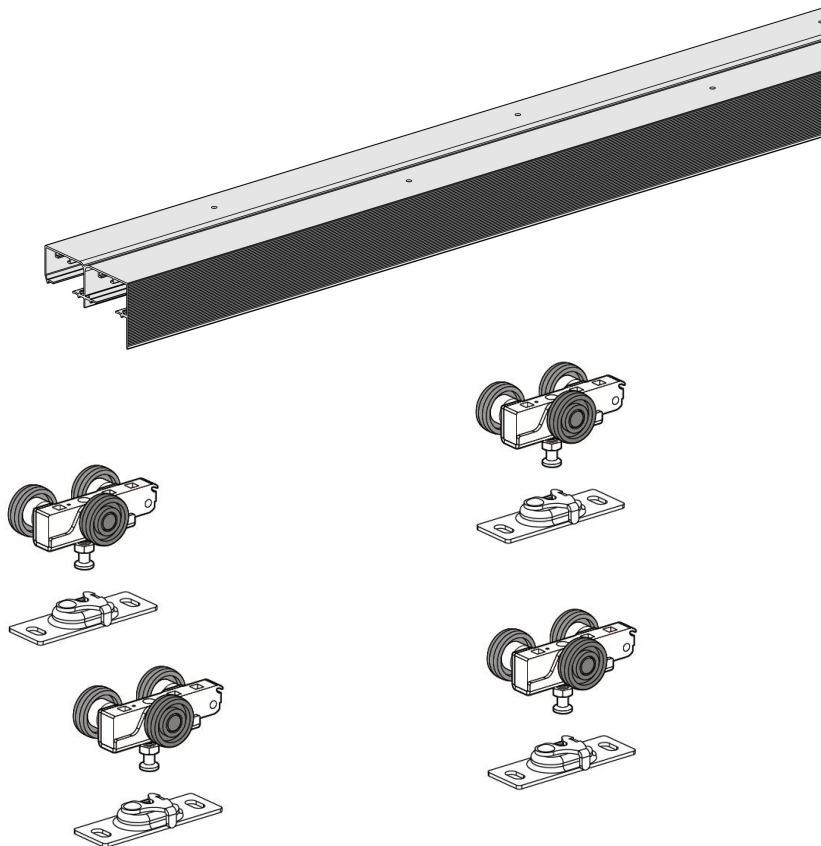

Queste sono le istruzioni originali, si prega di leggere attentamente tutte le istruzioni del manuale prima dell'uso. VEVOR si riserva la piena interpretazione del proprio manuale utente. L'aspetto del prodotto dipenderà dal prodotto ricevuto. Vi preghiamo di non informarvi più in caso di aggiornamenti tecnologici o software sul nostro prodotto.

INSTRUCTIONS

Grazie mille per aver scelto questo binario per porta scorrevole .

- Leggere attentamente tutte le istruzioni prima dell'uso. Le informazioni fornite aiuteranno a ottenere i migliori risultati possibili.

I prodotti presenti in questo catalogo potrebbero avere un colore diverso rispetto all'articolo reale .

CONSERVARE QUESTE ISTRUZIONI

AVVERTIMENTO:

Garantire la salute e la sicurezza, le autorità locali e le pratiche generali dei laboratori

vengano rispettate le norme quando si utilizzano gli utensili.

* NON utilizzare utensili se danneggiati.

* Mantenere gli utensili in buone condizioni e puliti per ottenere prestazioni ottimali e più sicure.

* Indossare indumenti adatti per evitare che si impiglino. Non indossare gioielli larghi e non legare i capelli lunghi.

* Tenere conto di tutti gli utensili e dei pezzi utilizzati.

* Se si lavora fuori dal veicolo, assicurarsi che il posto di lavoro sia sicuro e stabile.

* Non utilizzare questi strumenti se si è stanchi o sotto l'effetto di alcol, droghe o farmaci inebrianti.

* **SICUREZZA PERSONALE AVVERTENZA!**

Indossare sempre dispositivi di protezione individuale.

* **DISPOSITIVI DI PROTEZIONE INDIVIDUALE**

1. Indossare sempre occhiali di sicurezza antiurto che proteggano frontalmente e lateralmente gli occhi. I dispositivi di protezione per gli occhi devono essere conformi agli standard CSA Z94.3-07 o ANSI Z87.1 in base al tipo di lavoro svolto.

2. Indossare guanti che offrano protezione in base ai materiali di lavoro o che riducano gli effetti delle vibrazioni dell'utensile.



Conforme ai requisiti normativi UE pertinenti (CPR)305/2011 .

Manuale di installazione

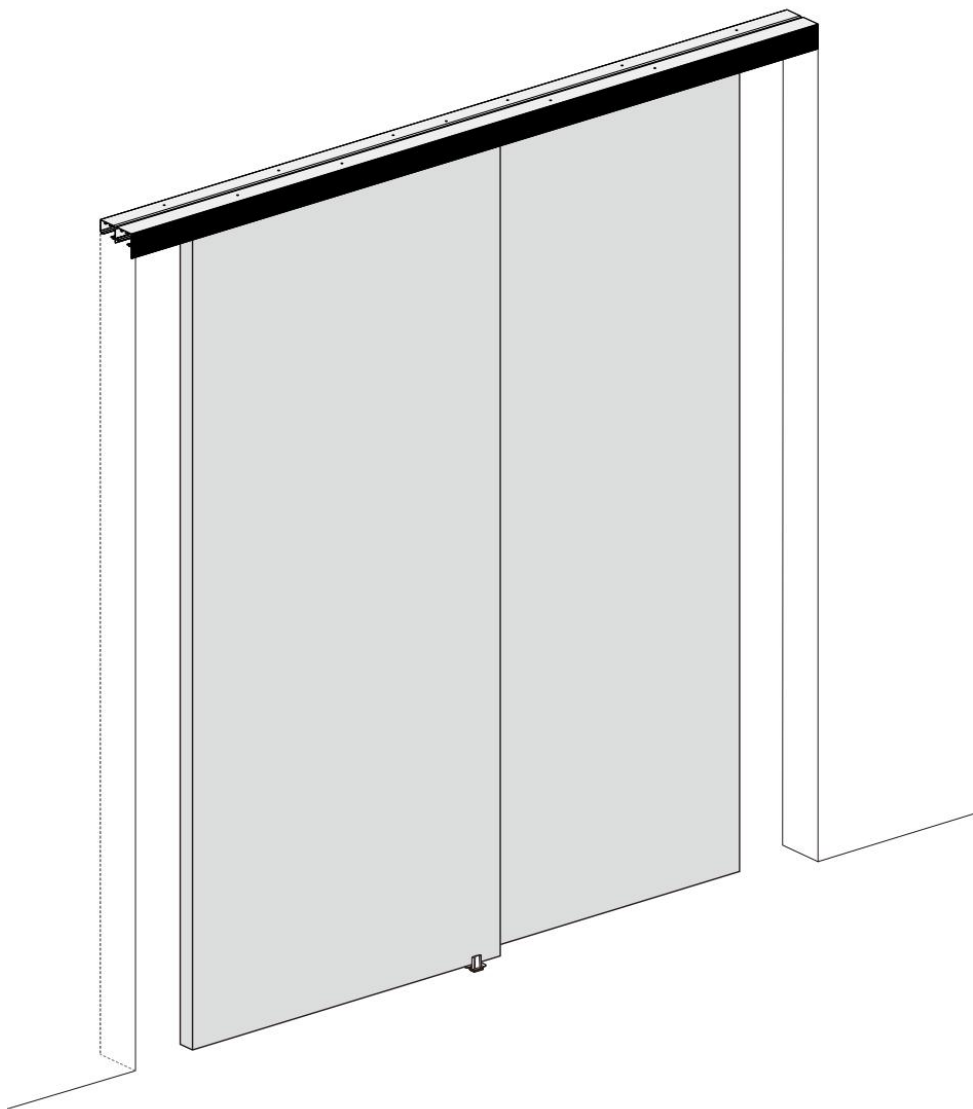

Elenco dei componenti

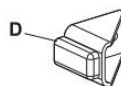
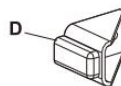
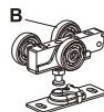
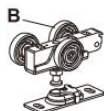
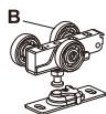
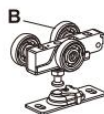
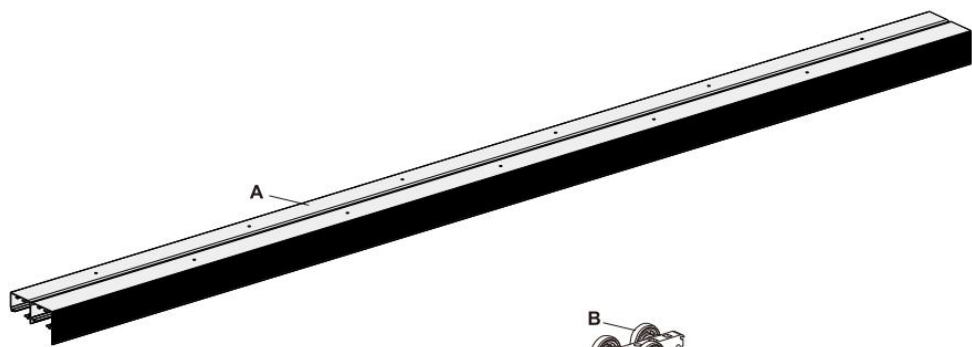

Parametri tecnici ed elenco delle parti

Parametri tecnici	
Nome	Binario per porta scorrevole
Modello	XC40B-5FT
Classificazione delle tracce	Doppio binario
Dimensioni della pista	60 " (1524 mm)
Chiusura ammortizzata	NO
Capacità di carico	300 libbre (136 kg)
Aspetto Colore	Nero

(XC40B-5FT) Elenco dei componenti			
Nome	Specifica	Quantità (pz)	Note
Traccia	/	1	Raddoppiare
Manuale utente	/	1	
Gancio (gruppo ruota)	/	4	Senza chiusura ammortizzata
Tappo	/	2	
Guida al pavimento	/	1	
Chiave	/	1	
Viti per montaggio a parete	/	10	9 per uso effettivo, 1 extra dal produttore
Viti per ruote di supporto	/	9	8 per uso effettivo, 1 extra dal produttore
Viti del dispositivo anti-oscillazione	/	3	2 per l'uso effettivo, 1 extra dal produttore
Vite di arresto	/	7	6 per uso effettivo, 1 extra dal produttore

Preinstallazione

TOOLS REQUIRED

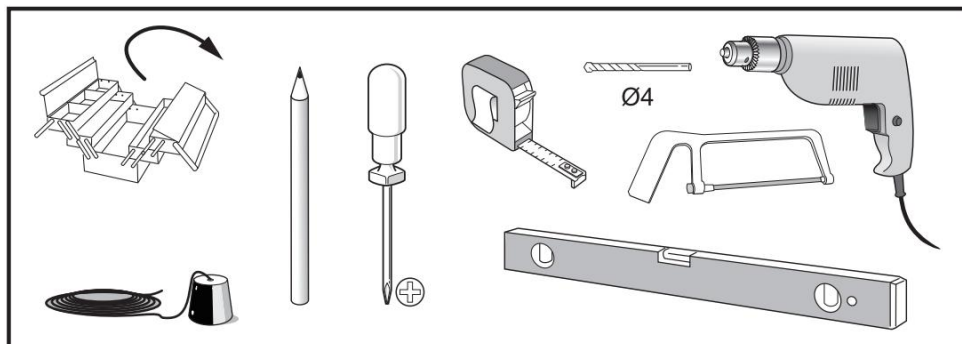

HARDWARE INCLUDED

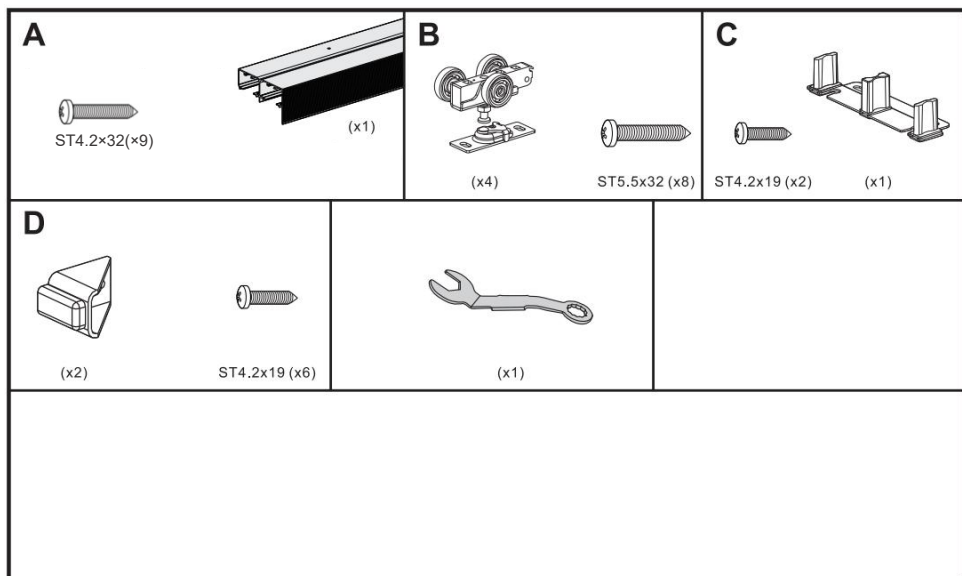

Installazione

Fits 35 and 45mm thick wood door
each door max weight 150lbs

2XDOOR

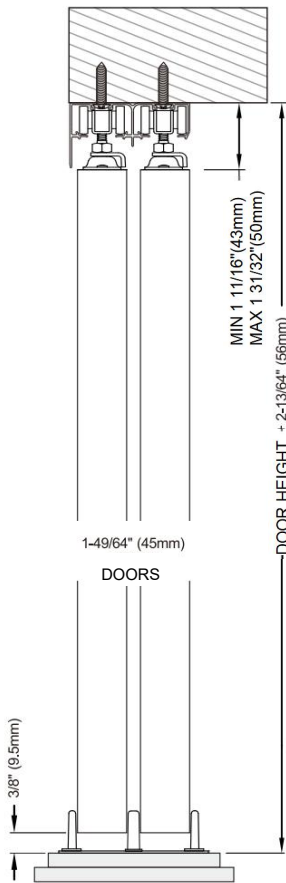
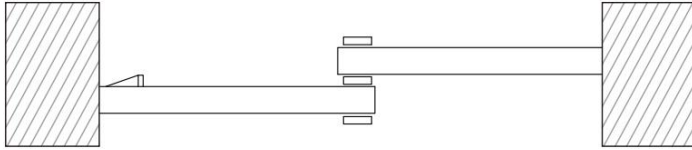

Installazione

1

A

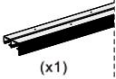

(x1)



ST4.2x32

B



(x4)

Install Track

Cut track to fit opening. Insert hangers into track and alternate wheel positions to distribute weight evenly. Mount track to header with screws.



2

B



(x4)



ST5.5x32 (x8)

Install Door Plates

Attach door plates on top of door 2-3/4" (70mm) from each edge with lock tabs on the same side.

45mm DOOR

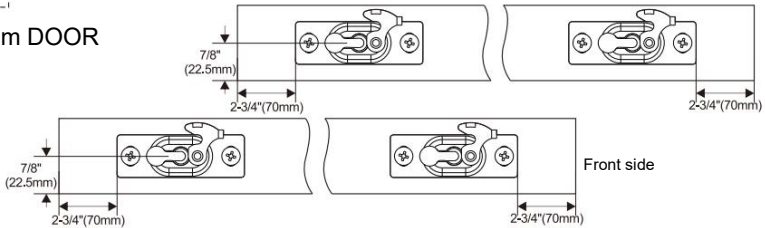

35mm DOOR

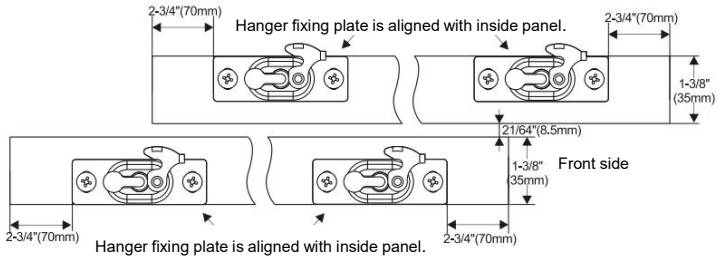

Installazione

3

B



(x4)

ST5.5x32 (x8)

Hang Doors on Track

Hang Door on front leg of track first, Mount door by locating door plate under adjusting bolt of hanger and lock into place. Check for smooth travel. Repeat with rear door.

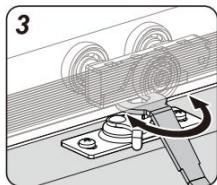
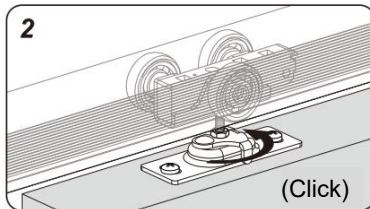
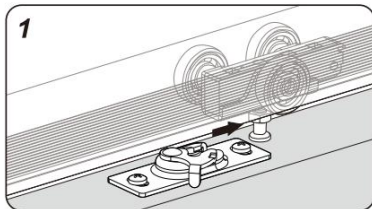

Use spanner to adjust door height

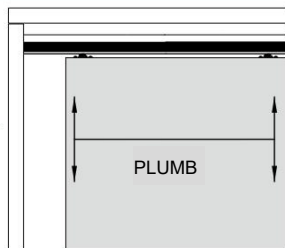
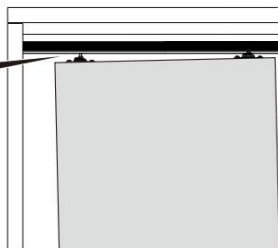

4

C



(x1)

ST4.2x19 (x2)

Install Floor Guide

Slide both doors to side jamb. Place guide between doors and position to plumb, then fasten to floor with screws.

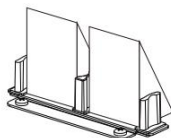
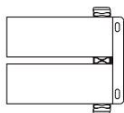

(default for 45 thick door)

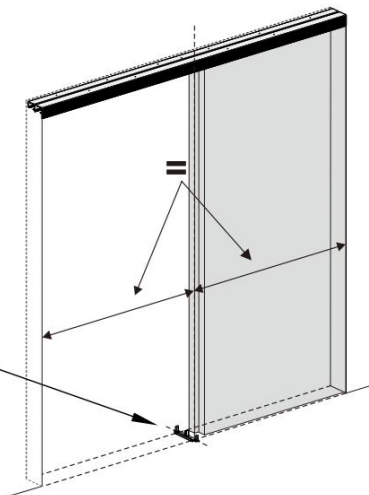

Installazione

4

NOTE: Floor guide installation instruction for 35mm thick wood door :

1

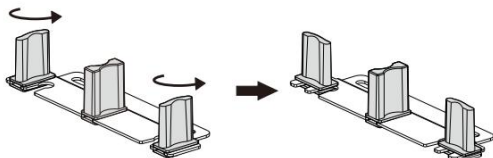

2

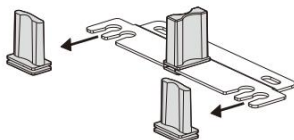

3

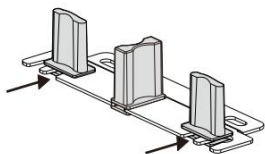

4

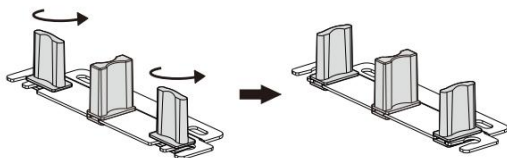

5

Door Adjustment

Use spanner to adjust door height through adjusting nut of hanger. Doors should plumb with jambs.

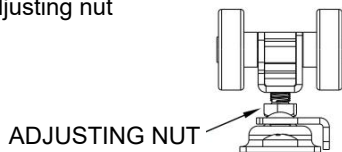

Installazione

6

D



(x2)



ST4.2x19 (x6)

Install Door Stop

Attach door stop on the back of front door, 1-1/2"(38mm) from door edge, 1/2"(13mm) from top (Hollow Core doors) or 40"(100mm) from bottom (Solid Core doors). Note: if other than pull is used, adjust location of stop to allow for access to rear door pull.

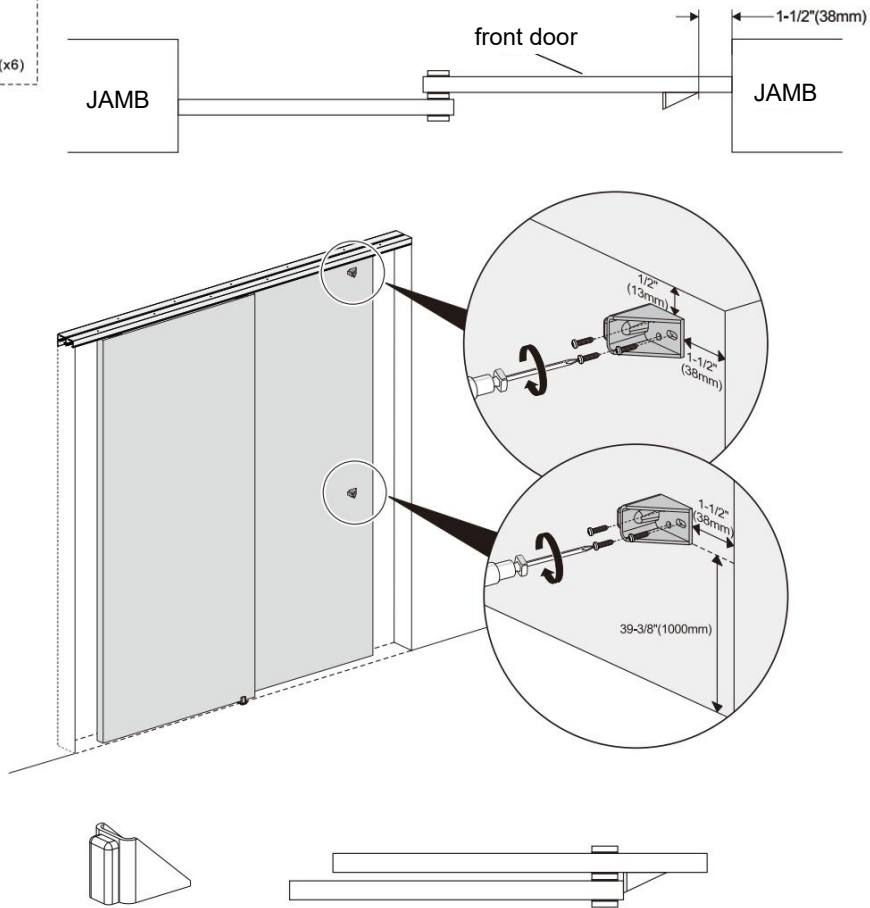

MAINTENANCE

8. Evitare l'esposizione prolungata al sole per prevenire l'invecchiamento.

Produttore: Shanghai muxinmuyeyouxiangongsi

Indirizzo: Shuangchenglu 803nong11hao1602A-1609shi, baoshanqu, Shanghai 200000 CN.

Importato in AUS: SIHAO PTY LTD. 1 ROKEVA STREET EASTWOOD
Nuovo Galles del Sud 2122 Australia

Importato negli USA: Sanven Technology Ltd. Suite 250, 9166 Anaheim
Luogo, Rancho Cucamonga, CA 91730

UK	REP	YH CONSULTING LIMITED. C/O YH Consulting Limited Office 147, Centurion House, London Road, Staines-upon-Thames, Surrey, TW18 4AX
-----------	------------	--

EC	REP	E-CrossStu GmbH Mainzer Landstr.69, 60329 Frankfurt am Main.
-----------	------------	--

