

# VEVOR

**Upgrade · The Home Creator Way**

## **Sliding Door Track**

**MODEL: XC40B-6FT**



Video of installation



MODEL: XC40B-6FT

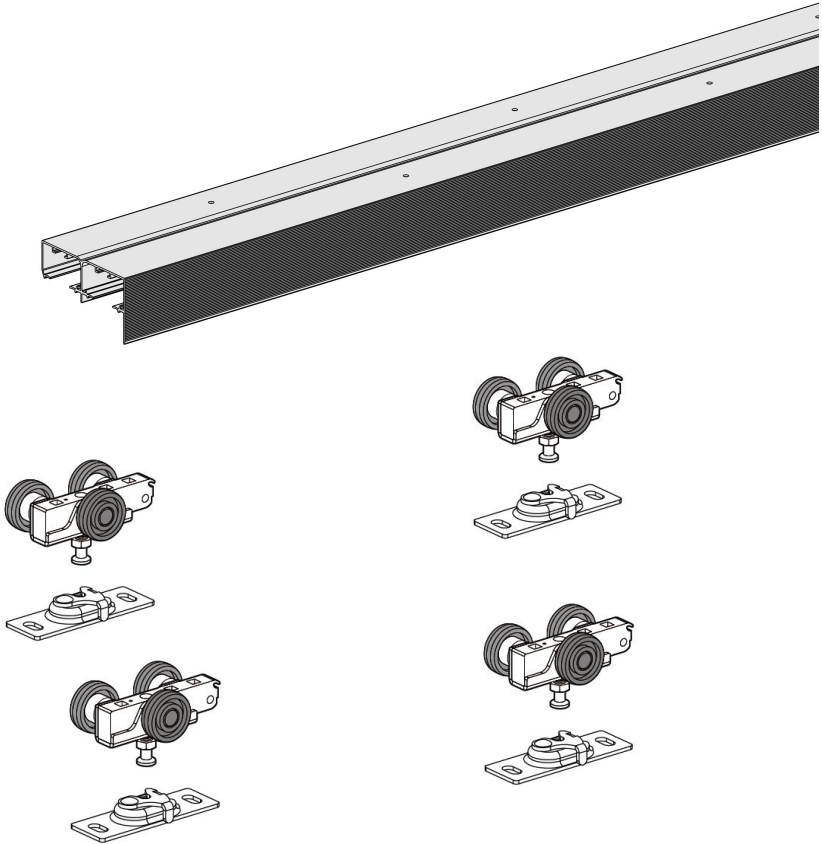

This is the original instruction, please read all manual instructions carefully before operating. VEVOR reserves a clear interpretation of our user manual. The appearance of the product shall be subject to the product you received. Please forgive us that we won't inform you again if there are any technology or software updates on our product.

# INSTRUCTIONS

Thank you very much for choosing this Sliding Door Track.

- Please read all of the instructions before using it. The information will help you achieve the best possible results.

The products carried in this catalog may be different in color than the actual item.

## SAVE THESE INSTRUCTIONS

### WARNING:

Ensure Health and Safety, local authority and general workshop practice regulations are adhered to when using tools.

\* DO NOT use tools if damaged.

\* Maintain tools in good and clean condition for best and safest performance.

\* Wear suitable clothing to avoid snagging. Do not wear loose jewellery and tie back long hair.

\* Account for all tools and parts being used.

\* If working off the vehicle, ensure that the workplace is secure and stable.

\* Do Not use these tools if you are tired or under the influence of alcohol, drugs or intoxicating medication.

\* PERSONAL SAFETY WARNING!

Always Wear personal protective equipment.

\*PERSONAL PROTECTIVE EQUIPMENT

1. Always wear impact safety goggles that provide front and side protection for the eyes. Eye protection equipment should comply with CSA Z94.3-07 or ANSI Z87.1 standards based on the type of work performed.

2. Wear gloves that provide protection based on the work materials or to reduce the effects of tool vibration.



**Conforms to relevant EU regulatory (CPR)305/2011 requirements.**

# Installation Manual

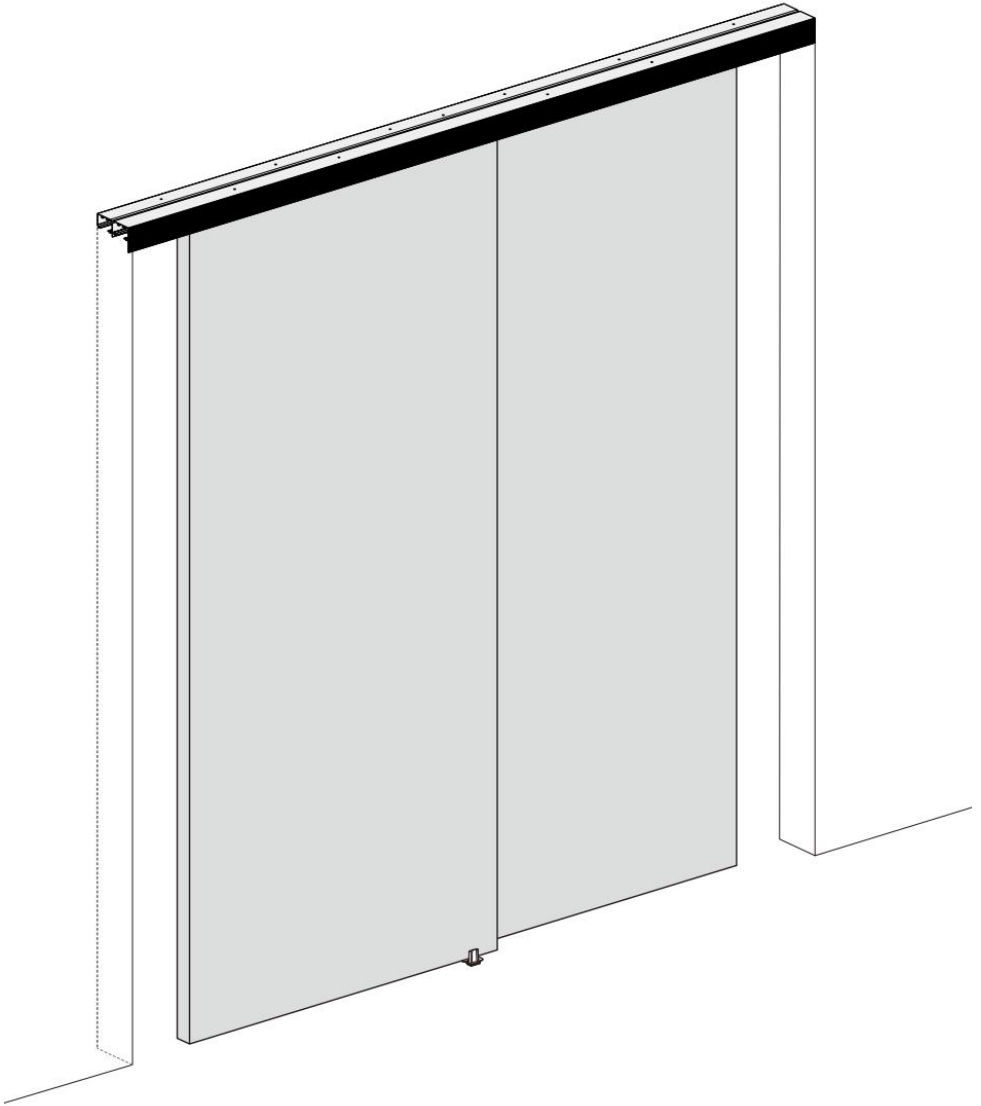

# Components list

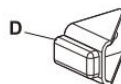
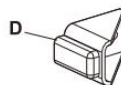
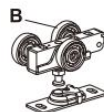
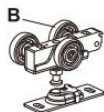
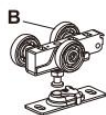
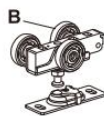
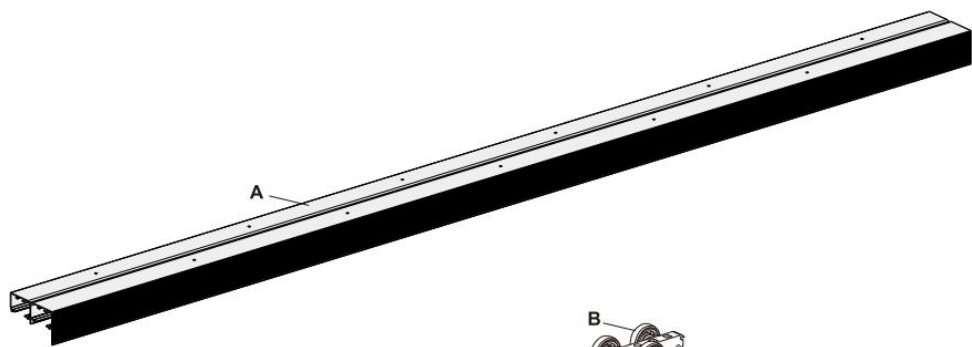

# Technical Parameters and Parts List

| Technical Parameters |                    |
|----------------------|--------------------|
| Name                 | Sliding Door Track |
| Model                | XC40B-6FT          |
| Track Classification | Double Track       |
| Track Dimensions     | 72"(1829mm)        |
| Soft Close           | No                 |
| Load Capacity        | 300LBS(136kg)      |
| Appearance Color     | Black              |







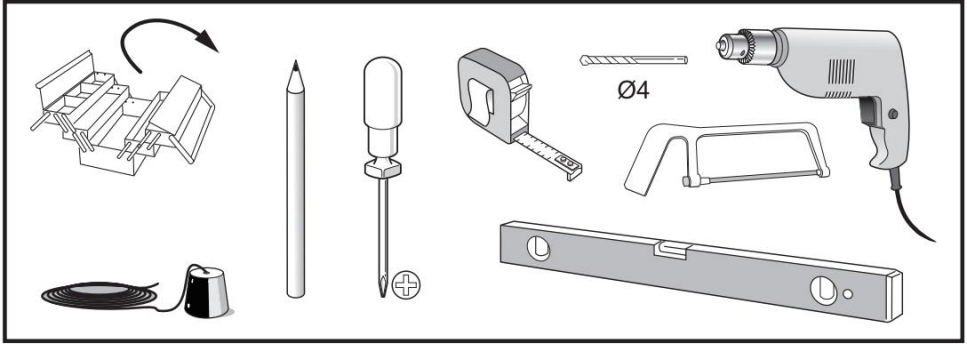

| (XC40B-6FT) Parts List  |               |           |  |
|-------------------------|---------------|-----------|--|
| Name                    | Specification | Qty (pcs) | Notes  |
| Track                   | /             | 1         | Double                                       |
| User Manual             | /             | 1         |  |
| Hanger(Wheel Assembly)  | /             | 4         | Without Soft Close                           |
| Stopper                 | /             | 2         |  |
| Floor Guide             | /             | 1         |  |
| Wrench                  | /             | 1         |  |
| Wall-mounting Screws    | /             | 12        | 11 for actual use, 1 extra from manufacturer |
| Hanger Wheel Screws     | /             | 9         | 8 for actual use, 1 extra from manufacturer  |
| Anti-Sway Device Screws | /             | 3         | 2 for actual use, 1 extra from manufacturer  |
| Stopper Screw           | /             | 7         | 6 for actual use, 1 extra from manufacturer  |

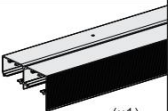
# Pre-installation

## TOOLS REQUIRED

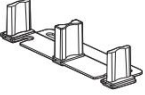

## HARDWARE INCLUDED

|   |   |  |
|---|---|--|
| <b>A</b><br><br>ST4.2x32(x11)<br><br>(x1)   | <b>B</b><br><br>(x4)<br><br>ST5.5x32 (x8) | <b>C</b><br><br>ST4.2x19 (x2)<br><br>(x1) |
| <b>D</b><br><br>(x2)<br><br>ST4.2x19 (x6) | <br>(x1)  |  |
|   |   |  |

# Installation

Fits 35 and 45mm thick wood door  
each door max weight 150lbs

2XDOOR

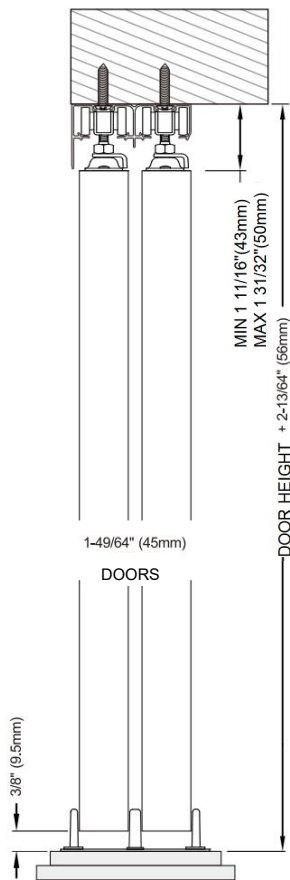
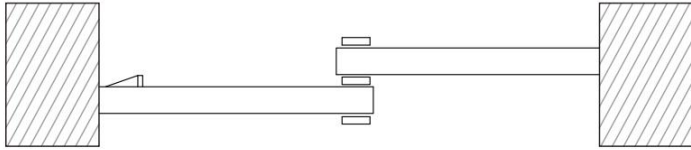

# Installation

**1**

**A**

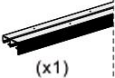

(x1)



ST4.2x32

**B**



(x4)

## Install Track

Cut track to fit opening. Insert hangers into track and alternate wheel positions to distribute weight evenly. Mount track to header with screws.



**2**

**B**



(x4)



ST5.5x32 (x8)

## Install Door Plates

Attach door plates on top of door 2-3/4" (70mm) from each edge with lock tabs on the same side.

### 45mm DOOR

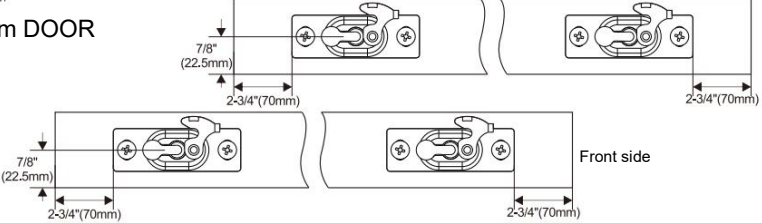

### 35mm DOOR

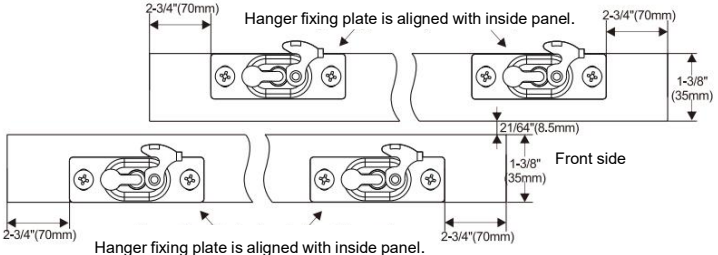

# Installation

**3**

## Hang Doors on Track

Hang Door on front leg of track first, Mount door by locating door plate under adjusting bolt of hanger and lock into place. Check for smooth travel. Repeat with rear door.

**B**



(x4)



ST5.5x32 (x8)

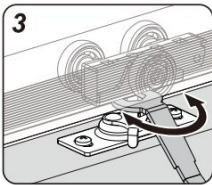
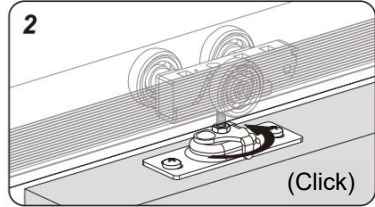
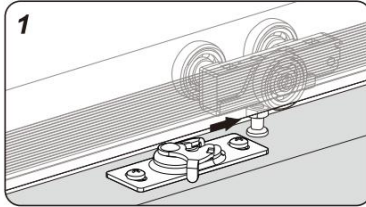

Use spanner to adjust door height

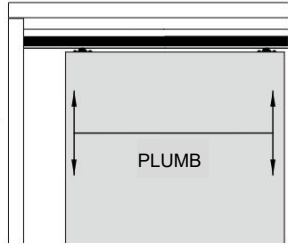
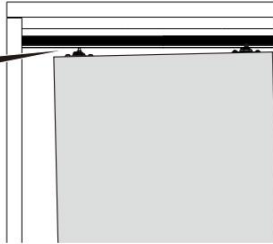

**4**

## Install Floor Guide

Slide both doors to side jamb. Place guide between doors and position to plumb, then fasten to floor with screws.

**C**



(x1)



ST4.2x19 (x2)

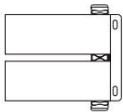

(default for 45 thick door)

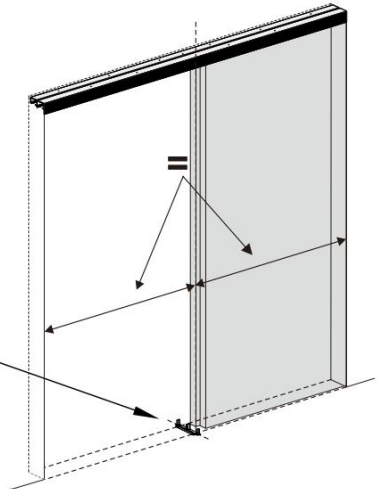
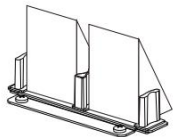

## Installation

4

**NOTE:** Floor guide installation instruction for 35mm thick wood door :

1

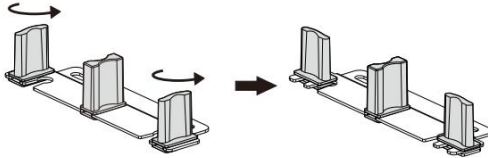

2

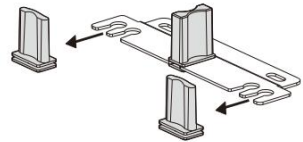

3

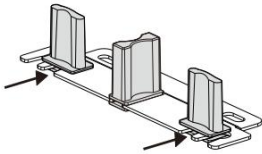

4

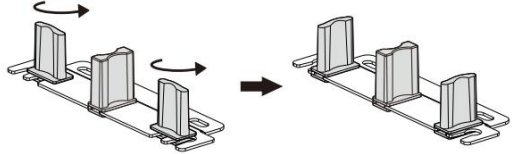

5

### Door Adjustment

Use spanner to adjust door height through adjusting nut of hanger. Doors should plumb with jambs.

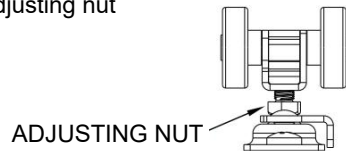

# Installation

6

D



(x2)



ST4.2x19 (x6)

## Install Door Stop

Attach door stop on the back of front door, 1-1/2"(38mm) from door edge, 1/2"(13mm) from top (Hollow Core doors) or 40"(100mm) from bottom (Solid Core doors). Note: if other than pull is used, adjust location of stop to allow for access to rear door pull.

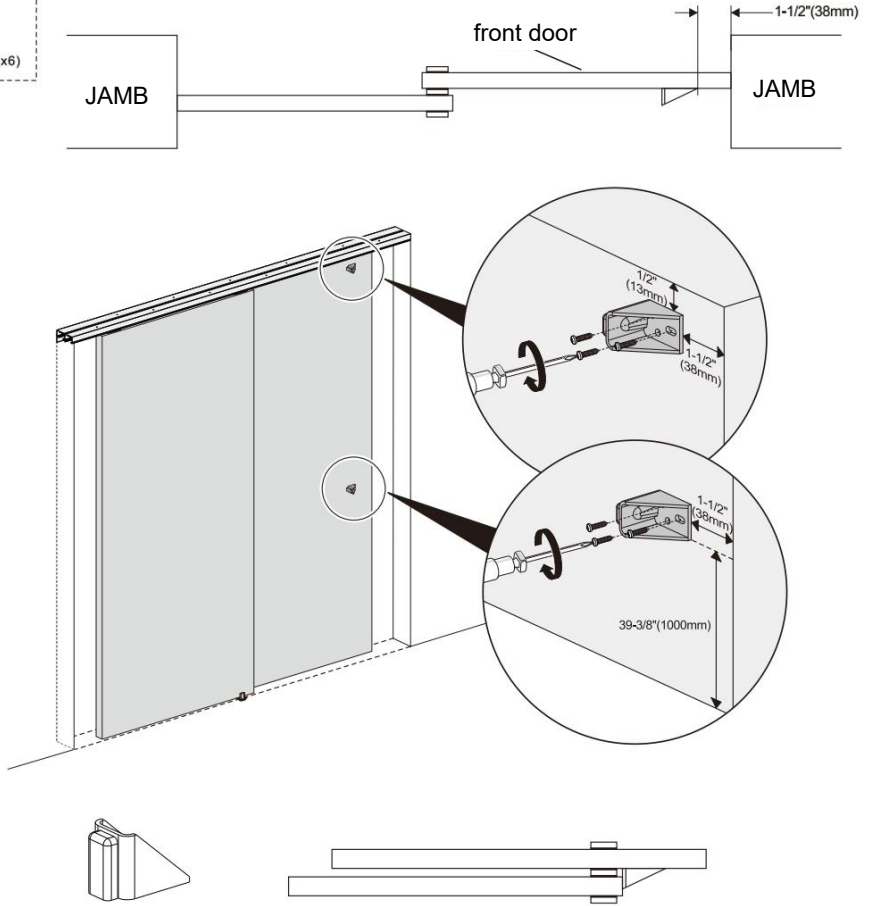

## MAINTENANCE

1. Avoid prolonged exposure to the sun to avoid aging.

**Manufacturer:** Shanghaimuxinmuyeyouxiangongsi

**Address:** Shuangchenglu 803nong11hao1602A-1609shi, baoshanqu, shanghai 200000 CN.

**Imported to AUS:** SIHAO PTY LTD. 1 ROKEVA STREETEASTWOOD NSW 2122 Australia

**Imported to USA:** Sanven Technology Ltd. Suite 250, 9166 Anaheim Place, Rancho Cucamonga, CA 91730

|           |            |  |
|-----------|------------|--|
| <b>UK</b> | <b>REP</b> | YH CONSULTING LIMITED. C/O YH Consulting Limited Office 147, Centurion House, London Road, Staines-upon-Thames, Surrey, TW18 4AX |
| <b>EC</b> | <b>REP</b> | E-CrossStu GmbH<br>Mainzer Landstr.69,<br>60329 Frankfurt am Main.   |





# VEVOR

**Upgrade · The Home Creator Way**

## **Schiebetürschiene**

**MODELL: XC40 B - 6 FUß**



Installationsvideo



MODELL: XC40B-6FT

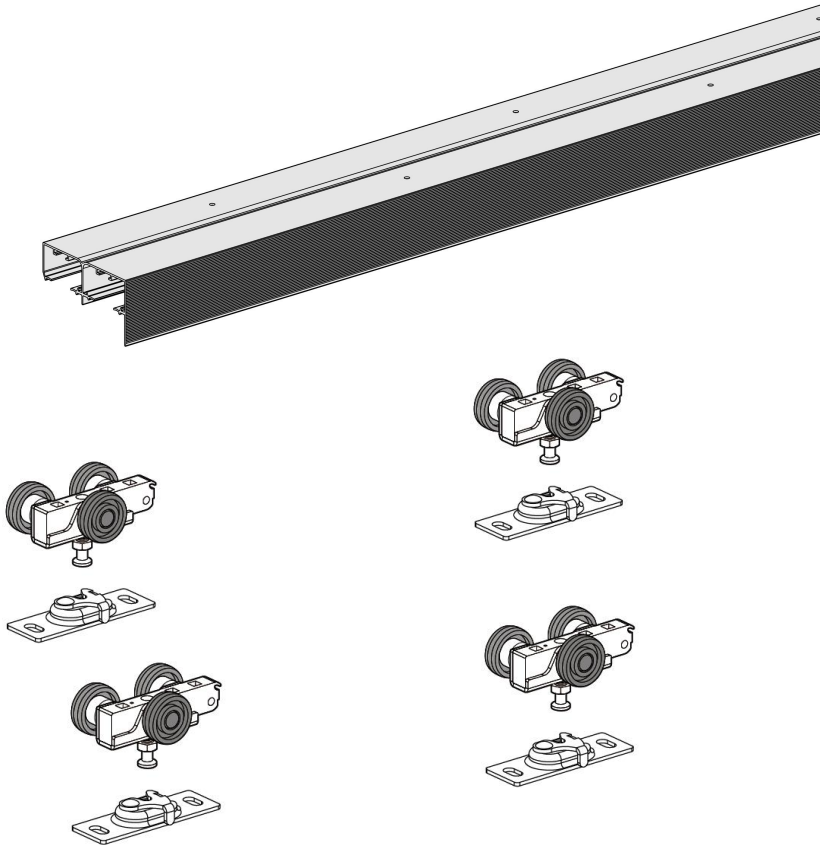

Dies ist die Originalanleitung. Bitte lesen Sie die gesamte Bedienungsanleitung vor der Inbetriebnahme sorgfältig durch. VEVOR behält sich die Auslegung der Bedienungsanleitung vor. Das Aussehen des Produkts kann von dem gelieferten Produkt abweichen. Wir bitten um Verständnis, dass wir Sie nicht erneut über etwaige Technologie- oder Software-Updates informieren werden .

## INSTRUCTIONS

Vielen Dank, dass Sie sich für diese Schiebetürschiene entschieden haben .

Bitte lesen Sie die gesamte Gebrauchsanweisung vor der Anwendung. Die Informationen helfen Ihnen, optimale Ergebnisse zu erzielen.

Die in diesem Katalog abgebildeten Produkte können farblich vom tatsächlichen Artikel abweichen .

### **BEWAHREN SIE DIESE ANWEISUNGEN AUF**

#### **WARNUNG:**

Gewährleistung von Gesundheit und Sicherheit, Einhaltung der Vorschriften der lokalen Behörden und allgemeine Werkstattpraxis  
Bei der Verwendung von Werkzeugen werden die Vorschriften eingehalten.

- \* Werkzeuge dürfen nicht verwendet werden, wenn sie beschädigt sind.
- \* Für optimale und sichere Leistung müssen die Werkzeuge stets in gutem und sauberem Zustand sein.
- \* Tragen Sie geeignete Kleidung, um ein Hängenbleiben zu vermeiden.  
Tragen Sie keinen losen Schmuck und binden Sie lange Haare zusammen.
- \* Alle verwendeten Werkzeuge und Teile müssen dokumentiert werden.
- \* Wenn Sie außerhalb des Fahrzeugs arbeiten, stellen Sie sicher, dass der Arbeitsplatz sicher und stabil ist.
- \* **Verwenden Sie** diese Werkzeuge nicht , wenn Sie müde sind oder unter dem Einfluss von Alkohol, Drogen oder berauschenden Medikamenten stehen.

#### **\* WICHTIGER HINWEIS ZUR PERSÖNLICHEN SICHERHEIT!**

Tragen Sie stets persönliche Schutzausrüstung.

#### **\* PERSÖNLICHE SCHUTZAUSRÜSTUNG**

1. Tragen Sie stets eine Schutzbrille, die Ihre Augen von vorne und von der Seite schützt. Die Augenschutzausrüstung muss je nach Art der ausgeführten Arbeit den Normen CSA Z94.3-07 oder ANSI Z87.1 entsprechen.

2. Tragen Sie Handschuhe, die je nach Arbeitsmaterial Schutz bieten oder die Auswirkungen von Werkzeugvibrationen reduzieren.



**Entspricht den einschlägigen Anforderungen der EU-Verordnung (CPR) 305/2011 .**

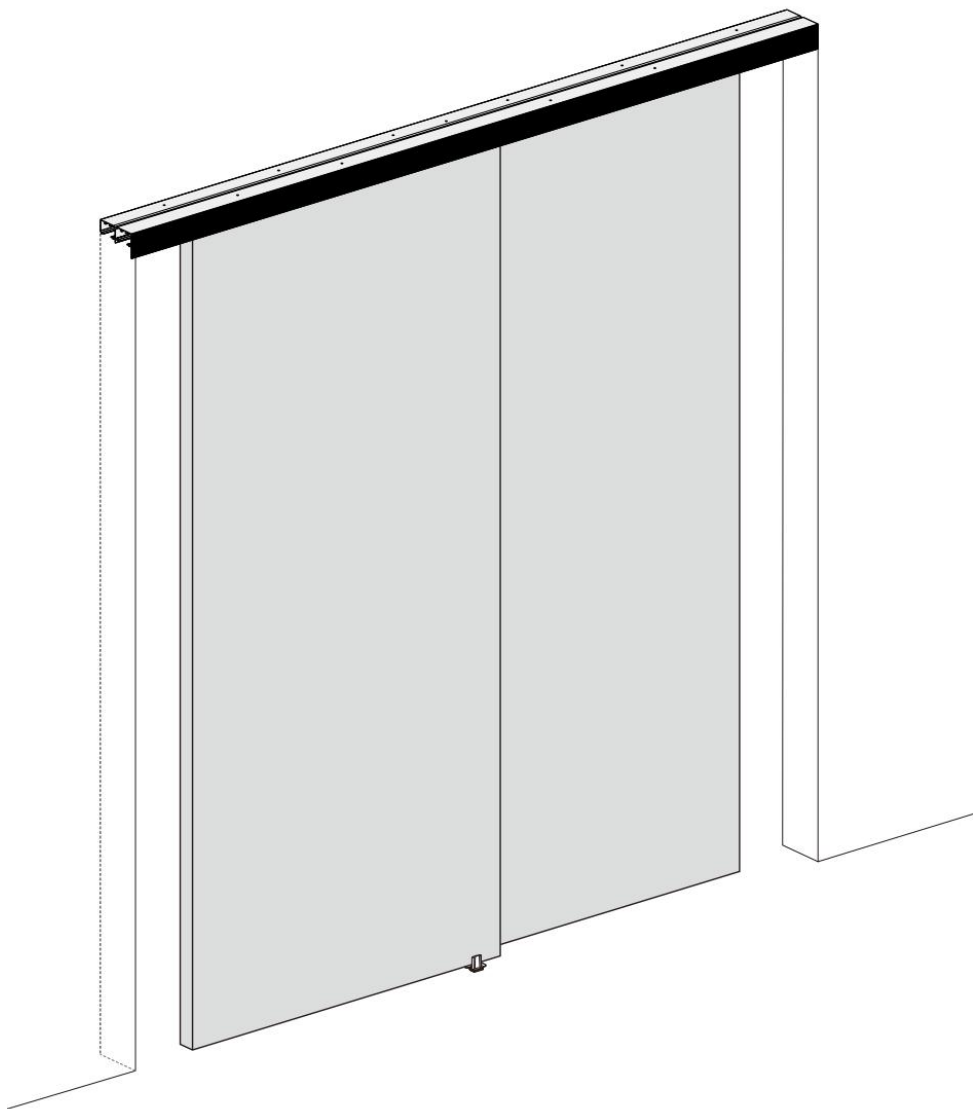

# Komponentenliste

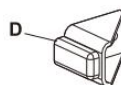
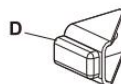
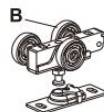
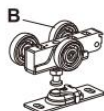
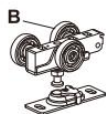
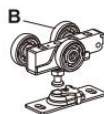
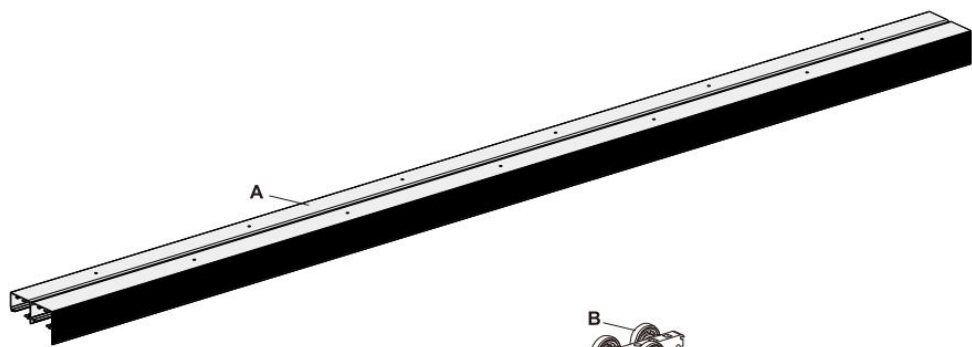

# Technische Parameter und Teileliste

| Technische Parameter |                      |
|----------------------|----------------------|
| Name                 | Schiebetürschiene    |
| Modell               | XC40B-6FT            |
| Gleisklassifizierung | Doppelgleis          |
| Gleisabmessungen     | 72 Zoll (1829 mm)    |
| Sanftes Schließen    | NEIN                 |
| Tragfähigkeit        | 300 Pfund ( 136 kg ) |
| Aussehen Farbe       | Schwarz              |

| ( XC40B-6FT ) Teileliste                 |               |               |  |
|--|---------------|---------------|--|
| Name                                     | Spezifikation | Menge (Stück) | Anmerkungen  |
| Schiene                                  | /             | 1             | Doppelt  |
| Benutzerhandbuch                         | /             | 1             |  |
| Aufhängung<br>( Radbaugruppe )           | /             | 4             | Ohne Soft-Close-Funktion   |
| Stopper                                  | /             | 2             |  |
| Bodenführung                             | /             | 1             |  |
| Schlüssel                                | /             | 1             |  |
| Wandbefestigungsschrauben                | /             | 12            | 11 Stück für den tatsächlichen Gebrauch, 1 zusätzliches Stück vom Hersteller |
| Aufhängungsradsschrauben                 | /             | 9             | 8 Stück für den tatsächlichen Gebrauch, 1 Stück zusätzlich vom Hersteller    |
| Schrauben der<br>Anti-Schwingvorrichtung | /             | 3             | 2 Stück für den tatsächlichen Gebrauch, 1 zusätzliches Stück vom Hersteller  |
| Stoppschraube                            | /             | 7             | 6 Stück für den tatsächlichen Gebrauch, 1 Stück zusätzlich vom Hersteller    |

## Vorinstallation

### TOOLS REQUIRED

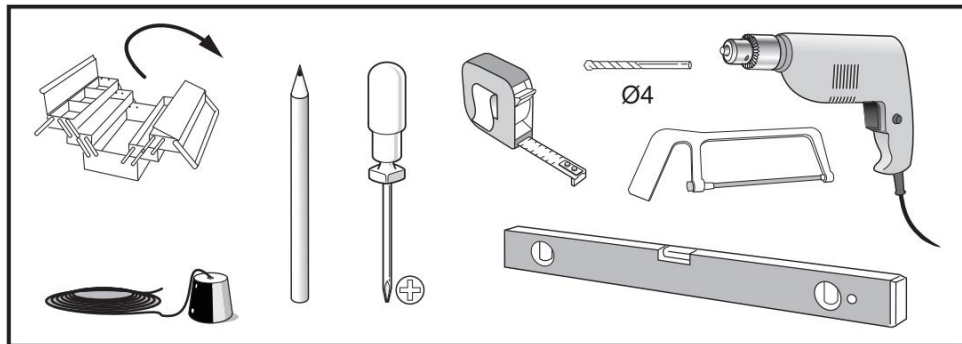

### HARDWARE INCLUDED

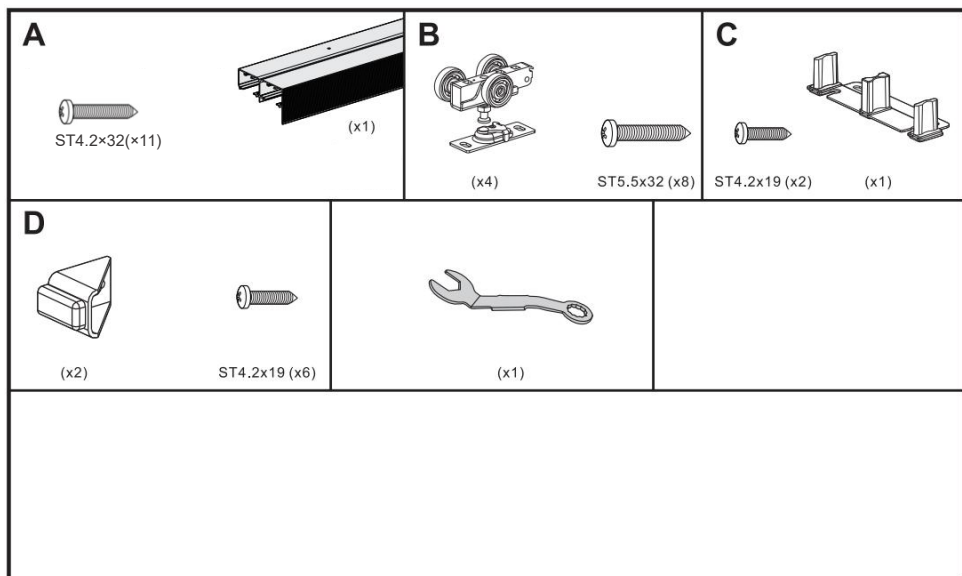

# Installation

Fits 35 and 45mm thick wood door  
each door max weight 150lbs

2XDOOR

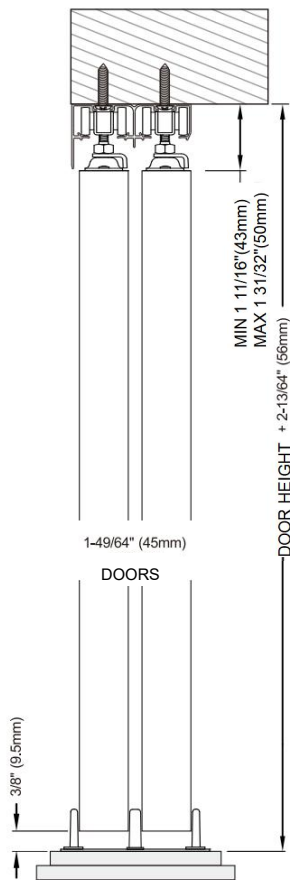
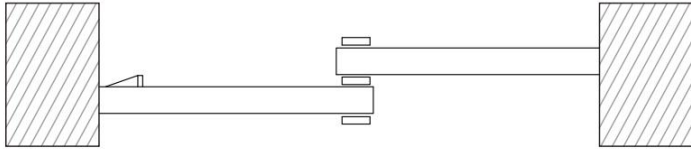

# Installation

**1**

**A**

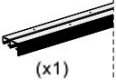

(x1)



ST4.2x32

**B**



(x4)

## Install Track

Cut track to fit opening. Insert hangers into track and alternate wheel positions to distribute weight evenly. Mount track to header with screws.



**2**

**B**



(x4)



ST5.5x32 (x8)

## Install Door Plates

Attach door plates on top of door 2-3/4" (70mm) from each edge with lock tabs on the same side.

### 45mm DOOR

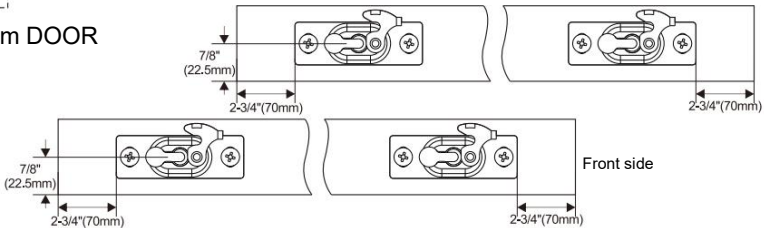

### 35mm DOOR

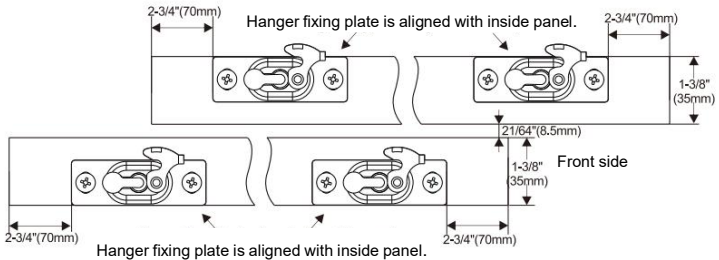

# Installation

**3**

## Hang Doors on Track

Hang Door on front leg of track first, Mount door by locating door plate under adjusting bolt of hanger and lock into place. Check for smooth travel. Repeat with rear door.

**B**



(x4)



ST5.5x32 (x8)

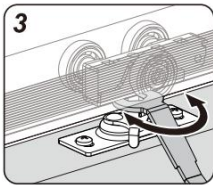
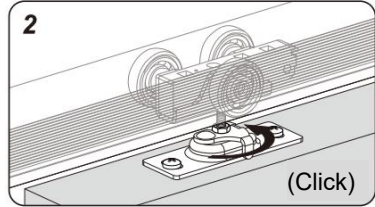
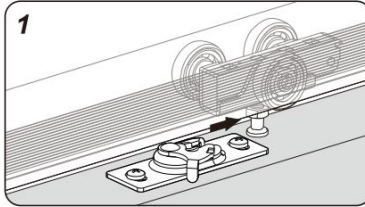

Use spanner to adjust door height

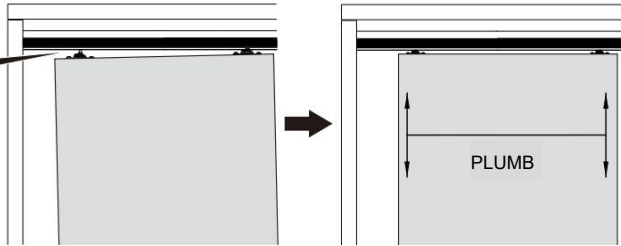

**4**

## Install Floor Guide

Slide both doors to side jamb. Place guide between doors and position to plumb, then fasten to floor with screws.

**C**



(x1)



ST4.2x19 (x2)

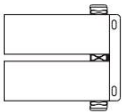

(default for 45 thick door)

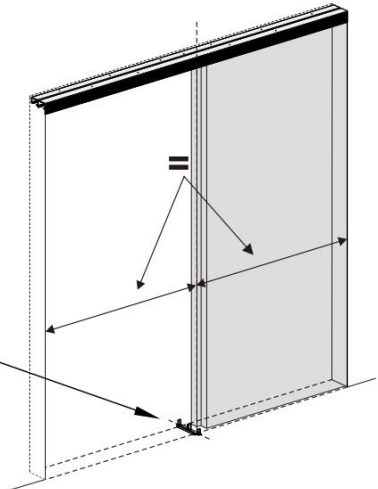
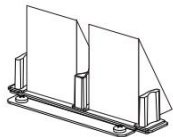

## Installation

4

**NOTE:** Floor guide installation instruction for 35mm thick wood door :

1

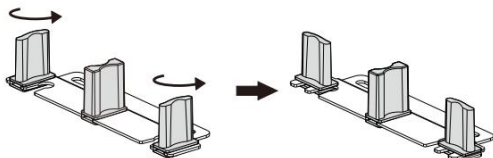

2

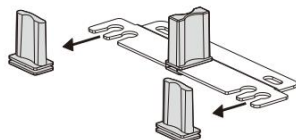

3

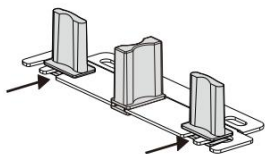

4

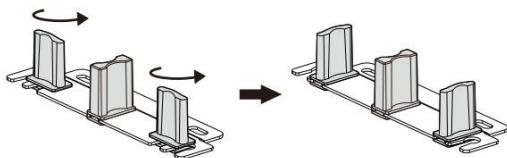

5

### Door Adjustment

Use spanner to adjust door height through adjusting nut of hanger. Doors should plumb with jambs.

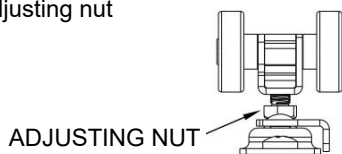

# Installation

6

D



(x2)



ST4.2x19 (x6)

## Install Door Stop

Attach door stop on the back of front door, 1-1/2"(38mm) from door edge, 1/2"(13mm) from top (Hollow Core doors) or 40"(100mm) from bottom (Solid Core doors). Note: if other than pull is used, adjust location of stop to allow for access to rear door pull.

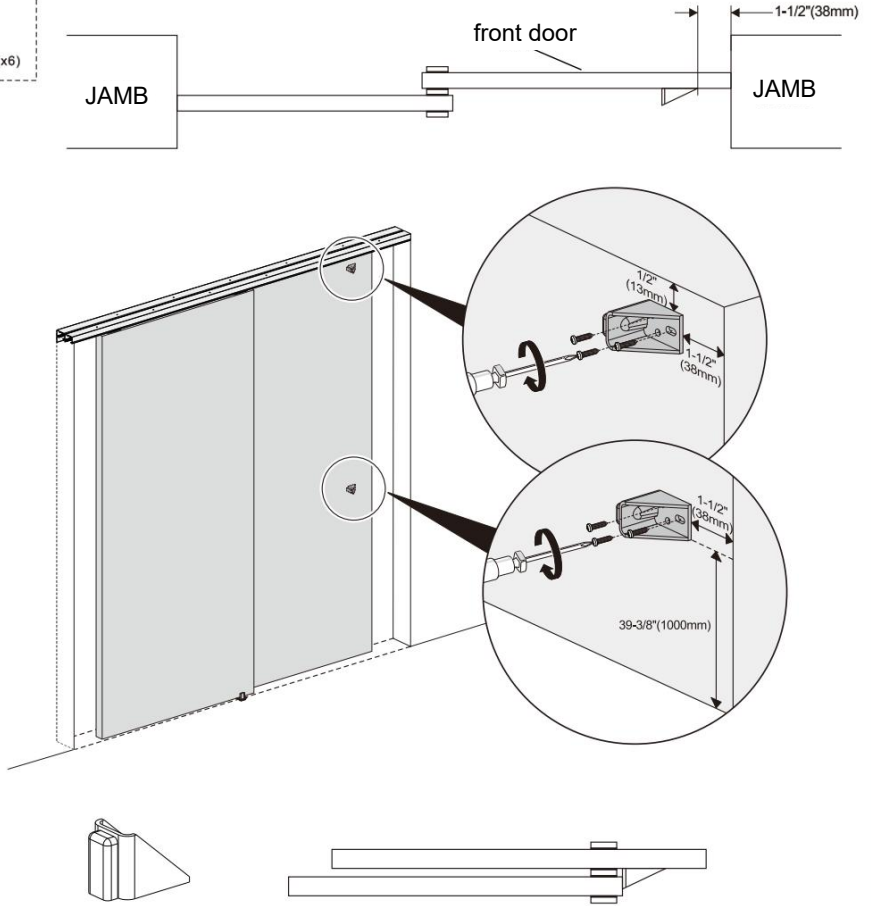

## MAINTENANCE

vermeiden.

2. Um der Hautalterung vorzubeugen, sollte man längere Sonnenexposition vermeiden.

**Hersteller:** Shanghaimuxinmuyeyouxiangongsi

**Adresse:** Shuangchenglu 803nong11hao1602A-1609shi, baoshanqu, Shanghai 200000 CN.

**Importiert nach Australien:** SIHAO PTY LTD. 1 ROKEVA STREET, EASTWOOD  
NSW 2122 Australien

**Importiert in die USA:** Sanven Technology Ltd. Suite 250, 9166 Anaheim Ort, Rancho Cucamonga, CA 91730

|           |            |  |
|-----------|------------|--|
| <b>UK</b> | <b>REP</b> | YH CONSULTING LIMITED. C/O YH Consulting Limited Office 147, Centurion House, London Road, Staines-upon-Thames, Surrey, TW18 4AX |
|-----------|------------|--|

|           |            |  |
|-----------|------------|--|
| <b>EC</b> | <b>REP</b> | E-CrossStu GmbH<br>Mainzer Landstr.69,<br>60329 Frankfurt am Main. |
|-----------|------------|--|





# VEVOR

**Upgrade · The Home Creator Way**

## **Rail de porte coulissante**

**MODÈLE: XC40 B - 1,83 M**



Vidéo d'installation



MODÈLE: XC40B-6FT

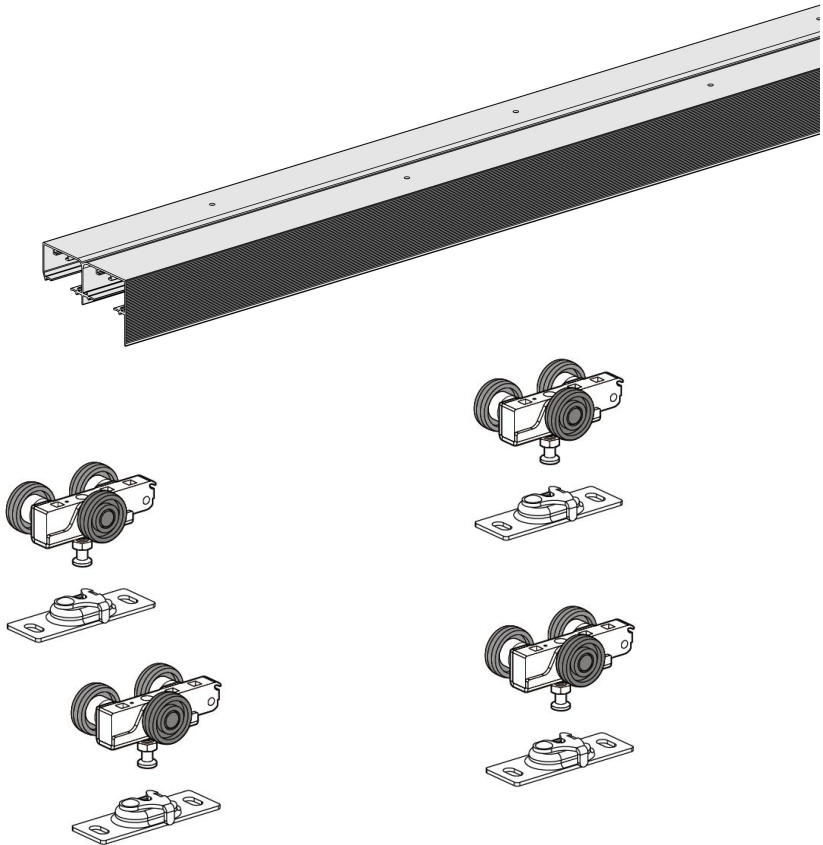

Voici le mode d'emploi original. Veuillez lire attentivement toutes les instructions du manuel avant utilisation. VEVOR se réserve le droit d'interpréter ce manuel à sa guise. L'apparence du produit que vous recevrez peut différer. Nous vous prions de nous excuser si nous ne vous informons pas des mises à jour techniques ou logicielles concernant notre produit.

# INSTRUCTIONS

Merci beaucoup d'avoir choisi ce rail de porte coulissante .

Veuillez lire attentivement toutes les instructions avant utilisation. Ces informations vous aideront à obtenir les meilleurs résultats possibles.

Les produits présentés dans ce catalogue peuvent avoir une couleur différente de celle du produit réel .

## CONSERVEZ CES INSTRUCTIONS

### AVERTISSEMENT:

Respectez les règles de santé et de sécurité, les réglementations des autorités locales et les pratiques générales d'atelier.

Les réglementations sont respectées lors de l'utilisation des outils.

\* N'utilisez PAS d'outils endommagés.

\* Maintenir les outils en bon état et propres pour une performance optimale et en toute sécurité.

\* Portez des vêtements adaptés pour éviter d'accrocher le tissu. Ne portez pas de bijoux amples et attachez vos cheveux longs.

\* Indiquez tous les outils et pièces utilisés.

\* Si vous travaillez à l'extérieur du véhicule, assurez-vous que le lieu de travail est sûr et stable.

\* N'utilisez pas ces outils si vous êtes fatigué ou sous l'influence de l'alcool, de drogues ou de médicaments intoxicants.

\* **AVERTISSEMENT CONCERNANT LA SÉCURITÉ PERSONNELLE !**

Portez toujours un équipement de protection individuelle.

\* **ÉQUIPEMENT DE PROTECTION INDIVIDUELLE**

1. Portez toujours des lunettes de sécurité à impact offrant une protection frontale et latérale des yeux. L'équipement de protection oculaire doit être conforme aux normes CSA Z94.3-07 ou ANSI Z87.1 selon le type de travail effectué.

2. Portez des gants de protection adaptés aux matériaux utilisés ou permettant de réduire les effets des vibrations des outils.



**Conforme aux exigences réglementaires européennes pertinentes  
(CPR)305/2011 .**

## Manuel d' installation

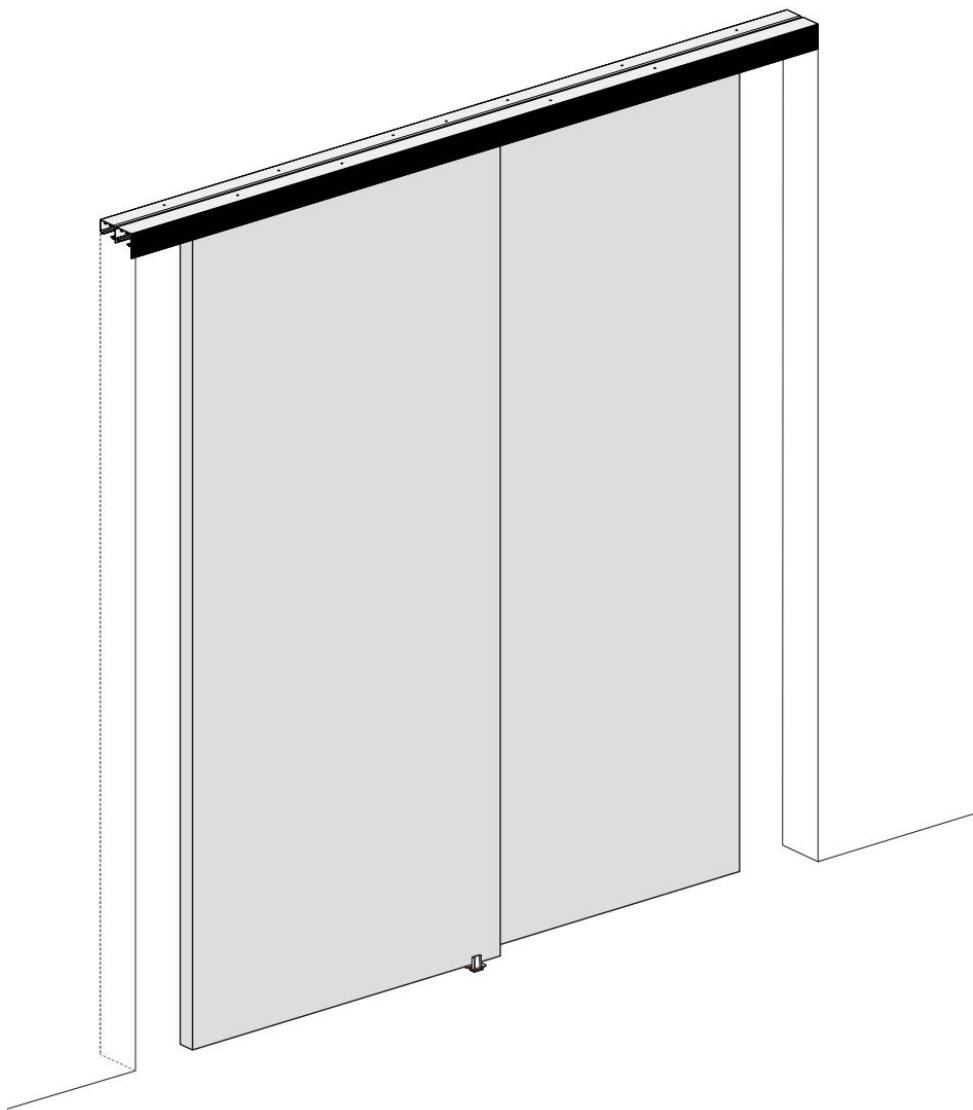

# Liste des composants

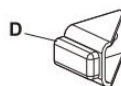
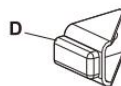
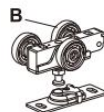
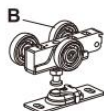
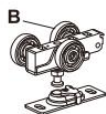
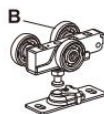
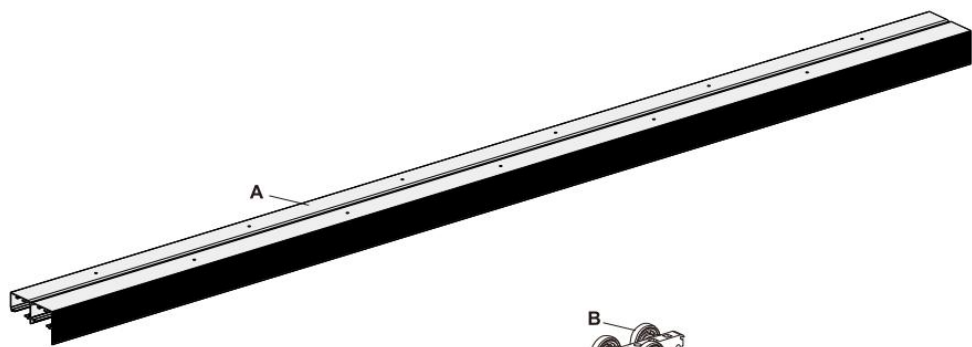

## Paramètres techniques et liste des pièces

| Paramètres techniques     |                           |
|---------------------------|---------------------------|
| Nom                       | Rail de porte coulissante |
| Modèle                    | XC40B-6FT                 |
| Classification des pistes | Double voie               |
| Dimensions de la voie     | 72 " (1829 mm)            |
| Fermeture douce           | Non                       |
| Capacité de charge        | 300 LBS ( 136 kg )        |
| Apparence Couleur         | Noir                      |

| Liste des pièces ( XC40B-6FT )        |               |                 |   |
|---------------------------------------|---------------|-----------------|---|
| Nom                                   | Spécification | Qté<br>(pièces) | Notes   |
| Piste                                 | /             | 1               | Double  |
| Manuel de l' utilisateur              | /             | 1               |   |
| Support ( Ensemble de<br>roue )       | /             | 4               | Sans fermeture douce  |
| Bouchon                               | /             | 2               |   |
| Guide des étages                      | /             | 1               |   |
| Clé                                   | /             | 1               |   |
| Vis de fixation murale                | /             | 12              | 11 pour une utilisation réelle, 1<br>supplémentaire fournie par le<br>fabricant |
| Vis de roue de suspension             | /             | 9               | 8 pour une utilisation réelle, 1<br>supplémentaire fournie par le<br>fabricant  |
| Vis du dispositif<br>anti-balancement | /             | 3               | 2 pour une utilisation réelle, 1<br>supplémentaire fournie par le<br>fabricant  |
| Vis d'arrêt                           | /             | 7               | 6 pour une utilisation réelle, 1<br>supplémentaire fournie par le<br>fabricant  |

## Pré-installation

### TOOLS REQUIRED

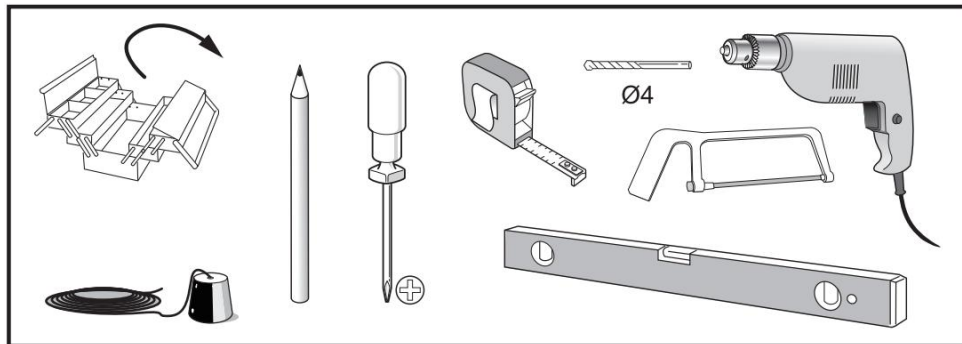

### HARDWARE INCLUDED

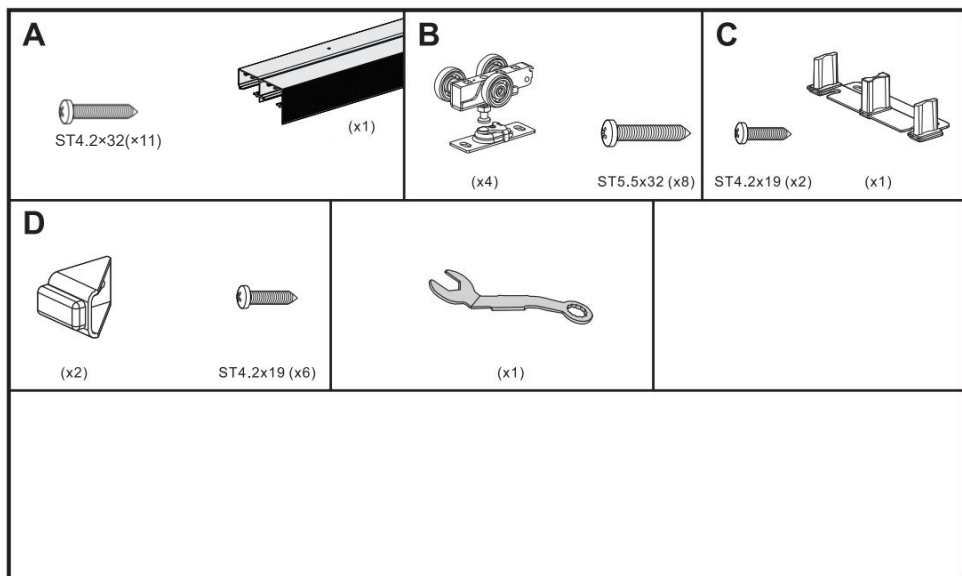

# Installation

Fits 35 and 45mm thick wood door  
each door max weight 150lbs

2XDOOR

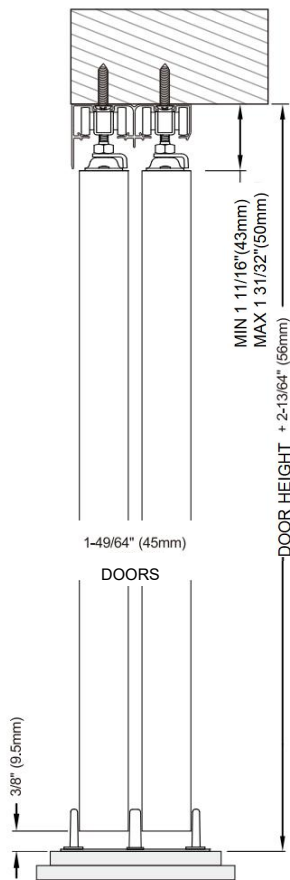
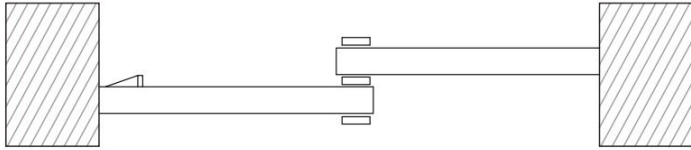

# Installation

**1**

**A**

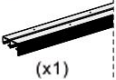

(x1)



ST4.2x32

**B**



(x4)

## Install Track

Cut track to fit opening. Insert hangers into track and alternate wheel positions to distribute weight evenly. Mount track to header with screws.



**2**

**B**



(x4)



ST5.5x32 (x8)

## Install Door Plates

Attach door plates on top of door 2-3/4" (70mm) from each edge with lock tabs on the same side.

### 45mm DOOR

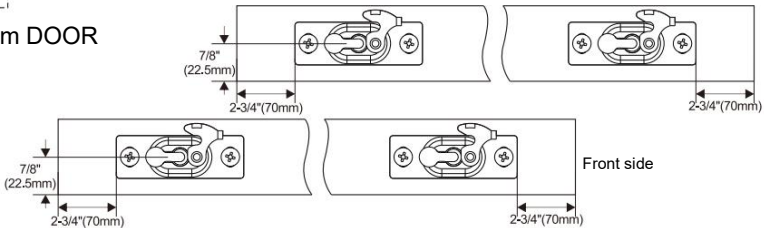

### 35mm DOOR

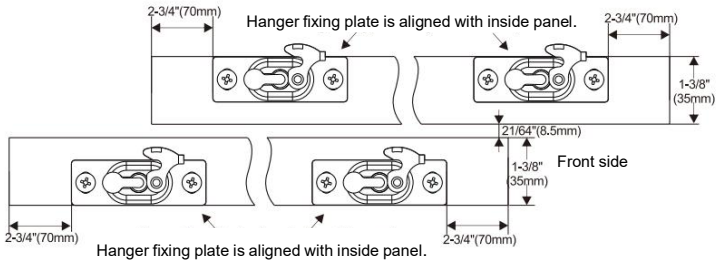

# Installation

**3**

## Hang Doors on Track

Hang Door on front leg of track first, Mount door by locating door plate under adjusting bolt of hanger and lock into place. Check for smooth travel. Repeat with rear door.

**B**



(x4)



ST5.5x32 (x8)

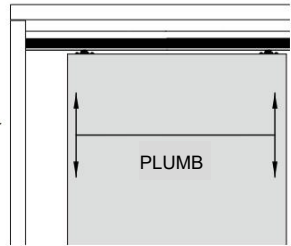
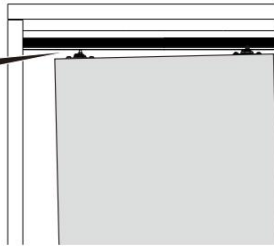
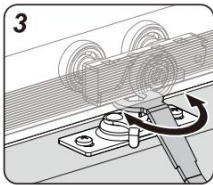
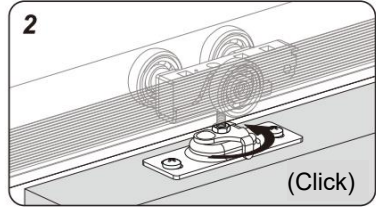
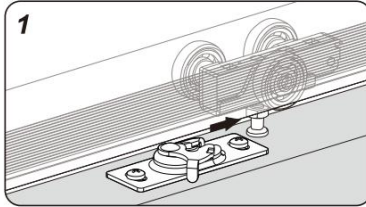

**4**

## Install Floor Guide

Slide both doors to side jamb. Place guide between doors and position to plumb, then fasten to floor with screws.

**C**



(x1)



ST4.2x19 (x2)

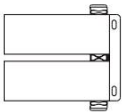

(default for 45 thick door)

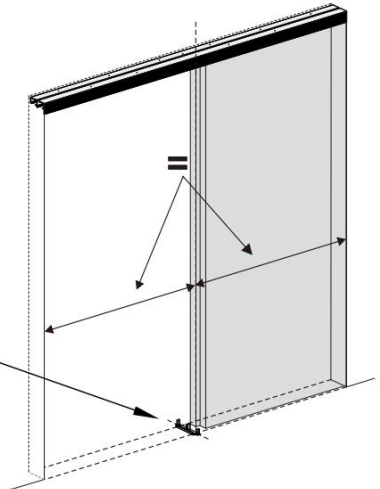
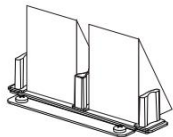

## Installation

4

**NOTE:** Floor guide installation instruction for 35mm thick wood door :

1

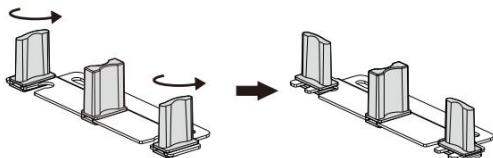

2

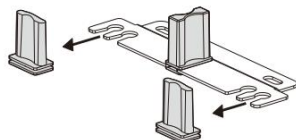

3

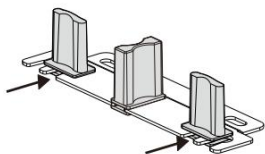

4

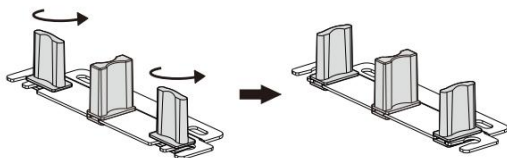

5

### Door Adjustment

Use spanner to adjust door height through adjusting nut of hanger. Doors should plumb with jambs.

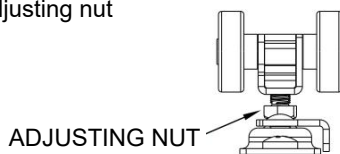

# Installation

6

D



(x2)



ST4.2x19 (x6)

## Install Door Stop

Attach door stop on the back of front door, 1-1/2"(38mm) from door edge, 1/2"(13mm) from top (Hollow Core doors) or 40"(100mm) from bottom (Solid Core doors). Note: if other than pull is used, adjust location of stop to allow for access to rear door pull.

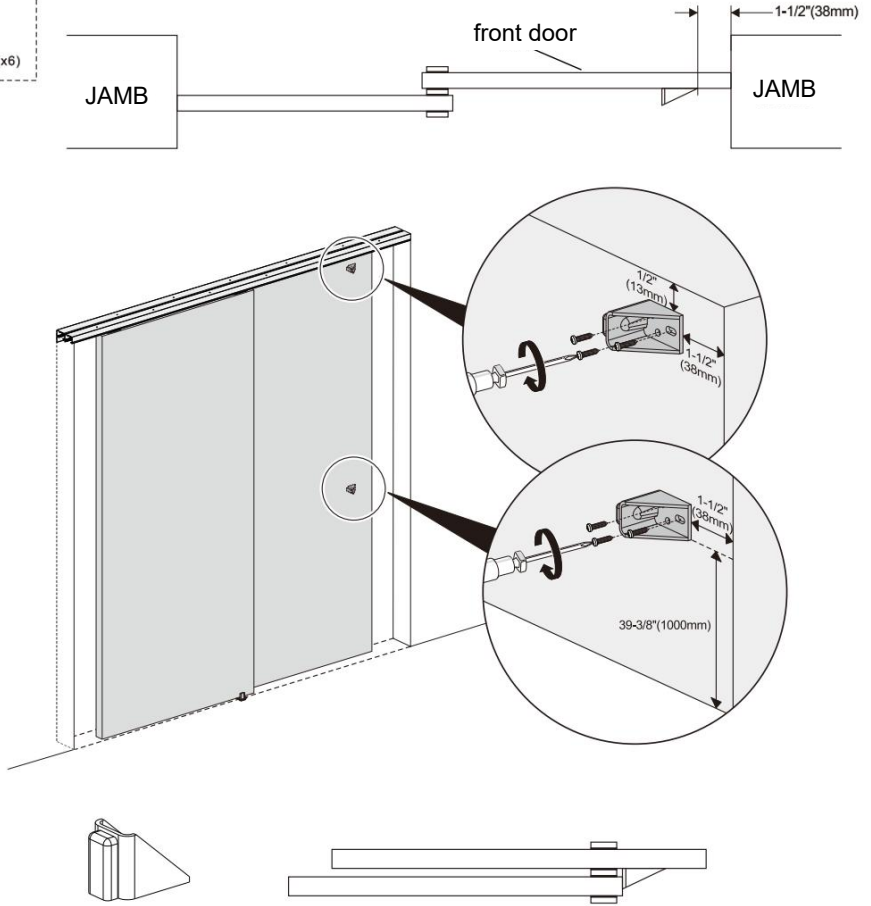

## MAINTENANCE

**3.** Évitez une exposition prolongée au soleil pour éviter le vieillissement.

**Fabricant :** Shanghai muxinmuyeyouxiangongsi

**Adresse :** Shuangchenglu 803nong11hao1602A-1609shi, baoshanqu, Shanghai 200000 CN.

**Importé en Australie :** SIHAO PTY LTD. 1 ROKEVA  
STREETEASTWOOD

NSW 2122 Australie

**Importé aux États-Unis :** Sanven Technology Ltd., Suite 250, 9166  
Anaheim

Rancho Cucamonga, CA 91730

|           |            |
|-----------|------------|
| <b>UK</b> | <b>REP</b> |
|-----------|------------|

YH CONSULTING LIMITED. C/O YH Consulting  
Limited Office 147, Centurion House, London  
Road, Staines-upon-Thames, Surrey, TW18 4AX

|           |            |
|-----------|------------|
| <b>EC</b> | <b>REP</b> |
|-----------|------------|

E-CrossStu GmbH  
Mainzer Landstr.69,  
60329 Frankfurt am Main.





# VEVOR

**Upgrade · The Home Creator Way**

## **Schuifdeurrail**

**MODEL: XC40 B - 6 FT**



Video van de installatie



MODEL: XC40B-6FT

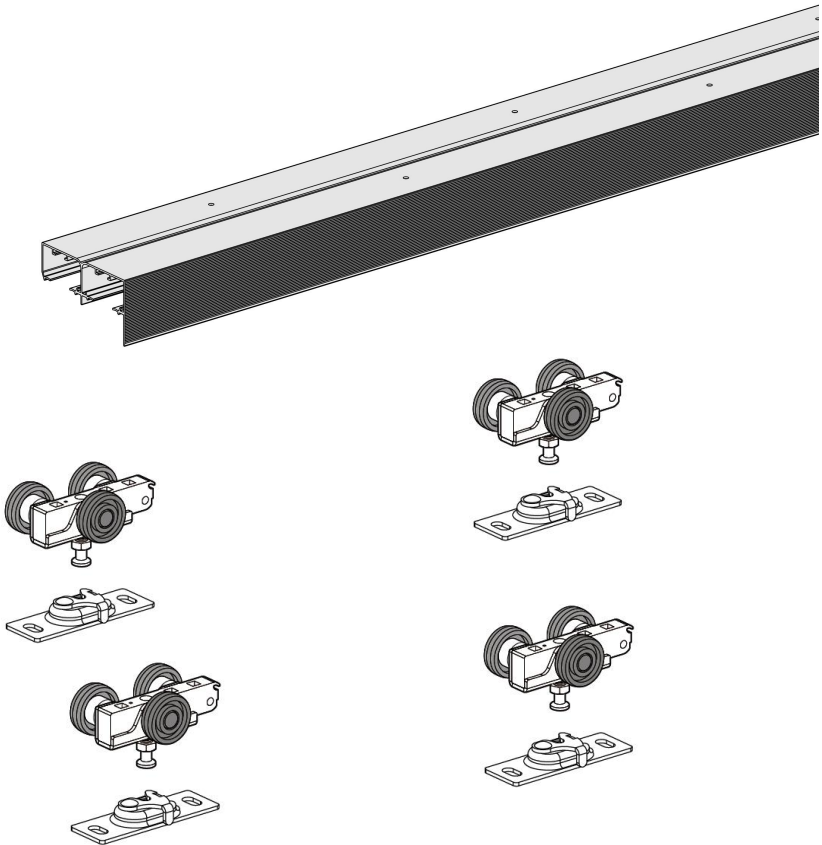

Dit is de originele handleiding. Lees alle instructies zorgvuldig door voordat u het product gebruikt. VEVOR behoudt zich het recht voor om de gebruiksaanwijzing duidelijk te interpreteren. Het uiterlijk van het product is afhankelijk van het product dat u hebt ontvangen. Neemt u het ons niet kwalijk dat we u niet meer op de hoogte stellen van eventuele technologische of software-updates voor ons product.

## INSTRUCTIONS

Hartelijk dank dat u voor deze schuifdeurrail hebt **gekozen** .

- Lees alle instructies aandachtig door voordat u het product gebruikt. Deze informatie helpt u de best mogelijke resultaten te behalen.

De in deze catalogus vermelde producten kunnen qua kleur afwijken van het daadwerkelijke artikel .

### BEWAAR DEZE INSTRUCTIES

#### WAARSCHUWING:

Zorg voor gezondheid en veiligheid, lokale autoriteiten en algemene werkplaatspraktijken

bij het gebruik van gereedschap worden de voorschriften in acht genomen.

\* **GEBRUIK GEEN** gereedschap als het beschadigd is.

\* Zorg ervoor dat het gereedschap in goede en schone staat verkeert voor de beste en veiligste prestaties.

\* Draag geschikte kleding om vasthaken te voorkomen. Draag geen losse sieraden en bind lang haar vast.

\* Houd bij welke gereedschappen en onderdelen u gebruikt.

\* Als u buiten het voertuig werkt, zorg er dan voor dat de werkplek veilig en stabiel is.

\* **Gebruik** deze hulpmiddelen niet als u moe bent of onder invloed bent van alcohol, drugs of bedwelmende medicijnen.

\* **PERSOONLIJKE VEILIGHEIDSWAARSCHUWING!**

Draag altijd persoonlijke beschermingsmiddelen.

\* **PERSOONLIJKE BESCHERMINGSMIDDELEN**

1. Draag altijd een veiligheidsbril die de ogen aan de voor- en zijkant beschermt. Oogbescherming moet voldoen aan de CSA Z94.3-07- of ANSI Z87.1-normen, afhankelijk van het soort werk dat wordt uitgevoerd.

2. Draag handschoenen die bescherming bieden op basis van het materiaal waarmee wordt gewerkt of om de effecten van gereedschapstrillingen te verminderen.



**Voldoet aan de relevante EU-regelgeving (CPR) 305/2011 .**

# Installatiehandleiding

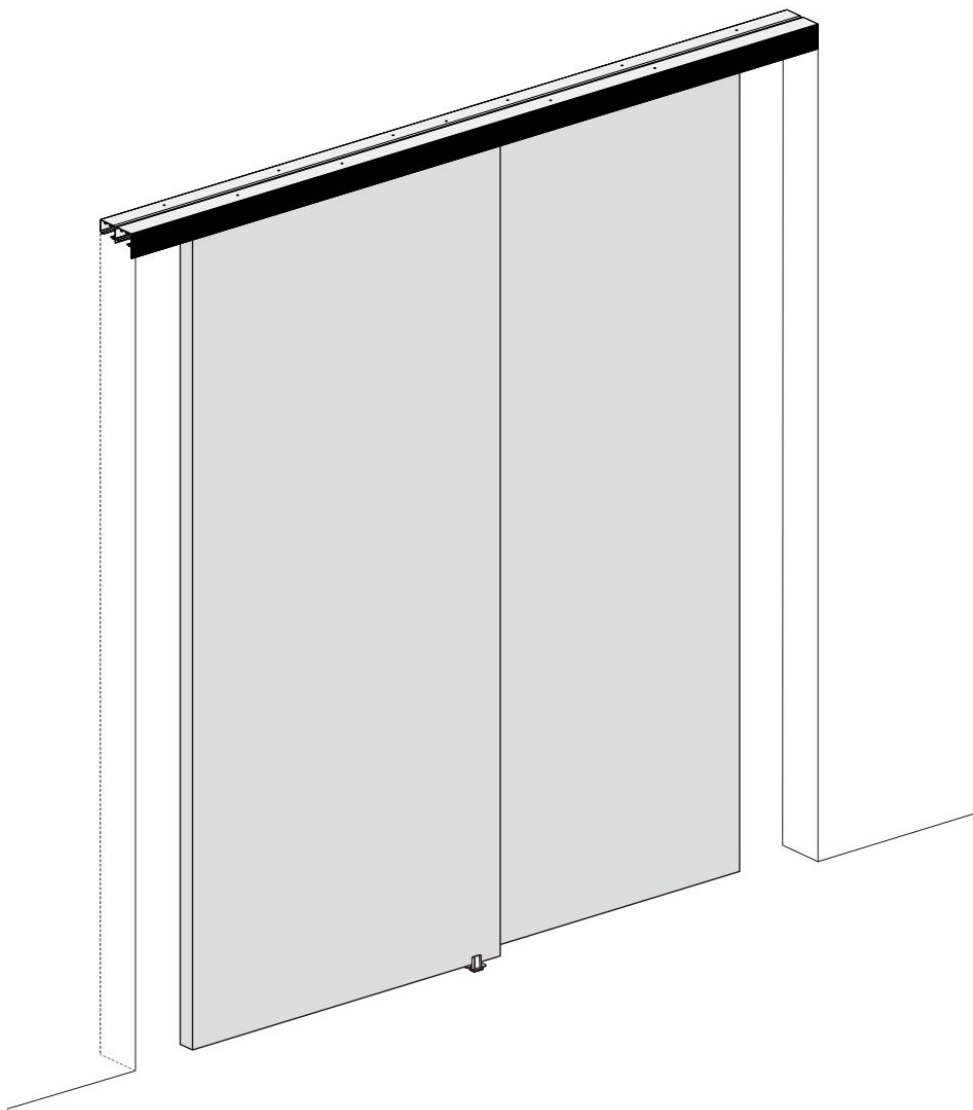

# Componentenlijst

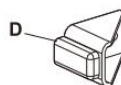
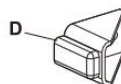
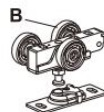
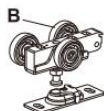
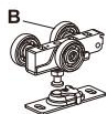
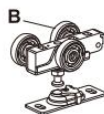
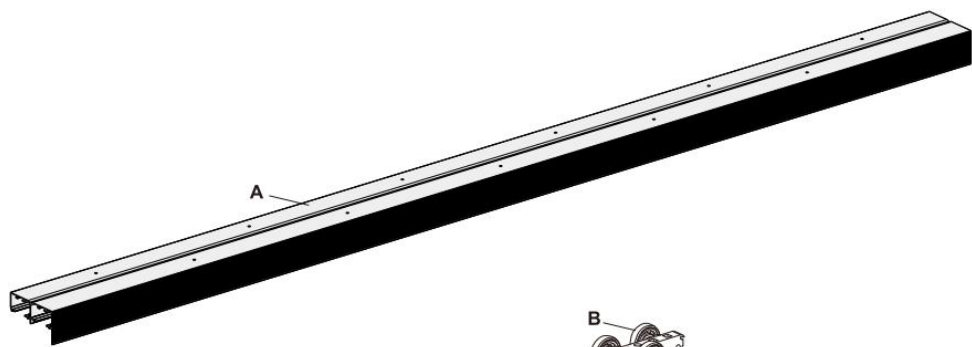

## Technische parameters en onderdelenlijst

| Technische parameters |                    |
|-----------------------|--------------------|
| Naam                  | Schuifdeurrail     |
| Model                 | XC40B-6FT          |
| Spoorclassificatie    | Dubbel spoor       |
| Spoorafmetingen       | 72 inch (1829 mm)  |
| Zacht sluiten         | Nee                |
| Laadvermogen          | 300 lbs ( 136 kg ) |
| Uiterlijk Kleur       | Zwart              |

| ( XC40B-6FT ) Onderdelenlijst     |              |                |   |
|-----------------------------------|--------------|----------------|---|
| Naam                              | Specificatie | Aantal (stuks) | Notities  |
| Spoor                             | /            | 1              | Dubbele   |
| Gebruikershandleiding             | /            | 1              |   |
| Hanger ( wielmontage )            | /            | 4              | Zonder softclose  |
| Stop                              | /            | 2              |   |
| Vloergids                         | /            | 1              |   |
| Moersleutel                       | /            | 1              |   |
| Schroeven voor wandmontage        | /            | 12             | 11 voor daadwerkelijk gebruik, 1 extra van de fabrikant |
| Schroeven voor het ophangwiel     | /            | 9              | 8 voor daadwerkelijk gebruik, 1 extra van de fabrikant  |
| Schroeven voor anti-sway-apparaat | /            | 3              | 2 voor daadwerkelijk gebruik, 1 extra van de fabrikant  |
| Stopschroef                       | /            | 7              | 6 voor daadwerkelijk gebruik, 1 extra van de fabrikant  |

# Pre-installatie

## TOOLS REQUIRED

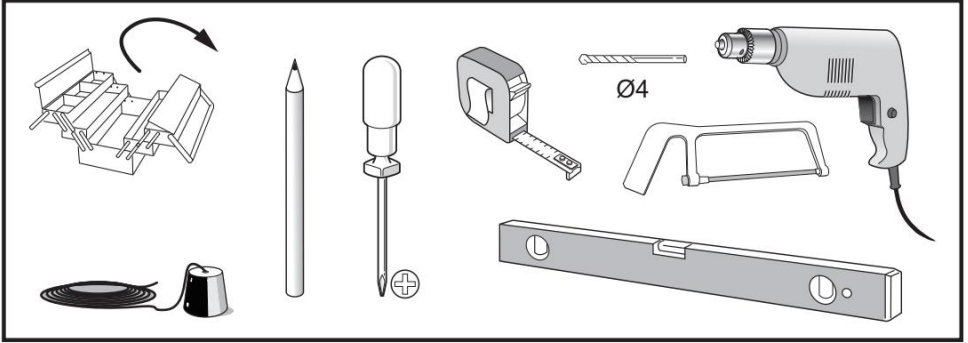

## HARDWARE INCLUDED

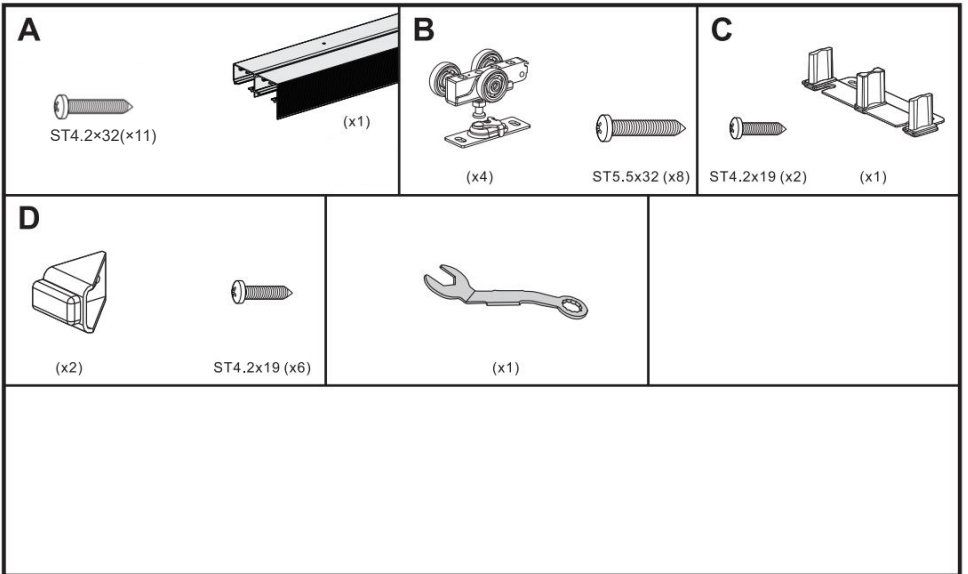

# Installatie

Fits 35 and 45mm thick wood door  
each door max weight 150lbs

2XDOOR

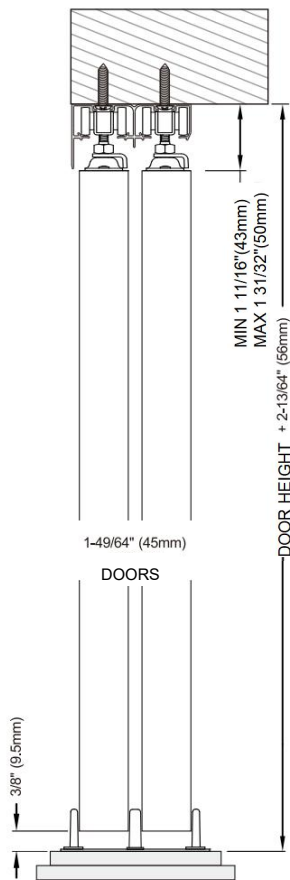
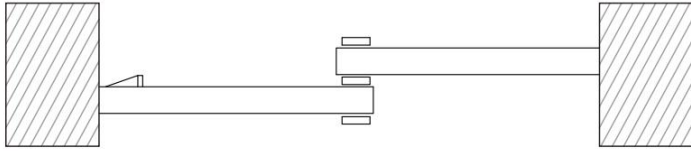

# Installatie

**1**

**A**

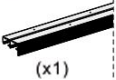

(x1)



ST4.2x32

**B**



(x4)

## Install Track

Cut track to fit opening. Insert hangers into track and alternate wheel positions to distribute weight evenly. Mount track to header with screws.



**2**

**B**



(x4)



ST5.5x32 (x8)

## Install Door Plates

Attach door plates on top of door 2-3/4" (70mm) from each edge with lock tabs on the same side.

### 45mm DOOR

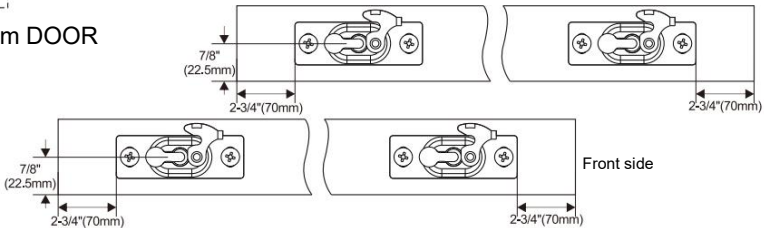

### 35mm DOOR

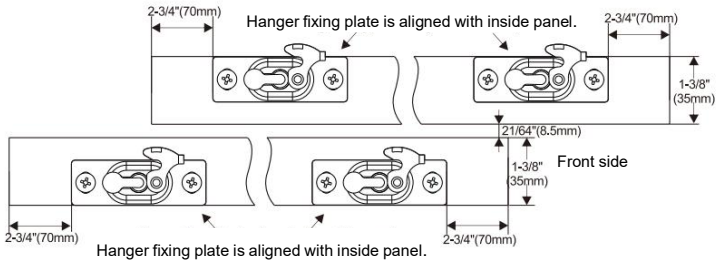

# Installatie

**3**

## Hang Doors on Track

Hang Door on front leg of track first, Mount door by locating door plate under adjusting bolt of hanger and lock into place. Check for smooth travel. Repeat with rear door.

**B**



(x4)



ST5.5x32 (x8)

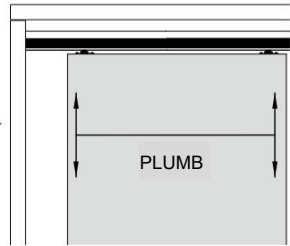
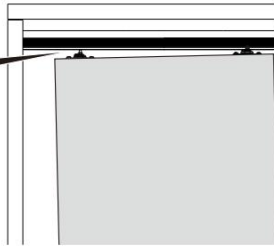
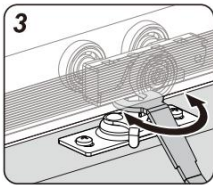
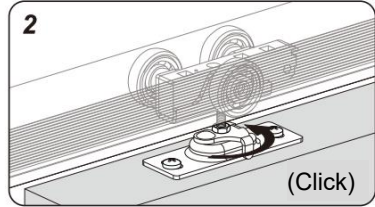
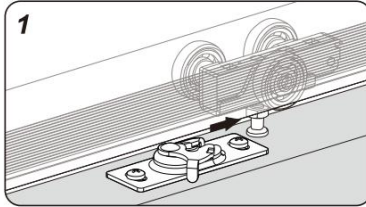

**4**

## Install Floor Guide

Slide both doors to side jamb. Place guide between doors and position to plumb, then fasten to floor with screws.

**C**



(x1)



ST4.2x19 (x2)

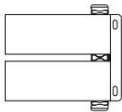

(default for 45 thick door)

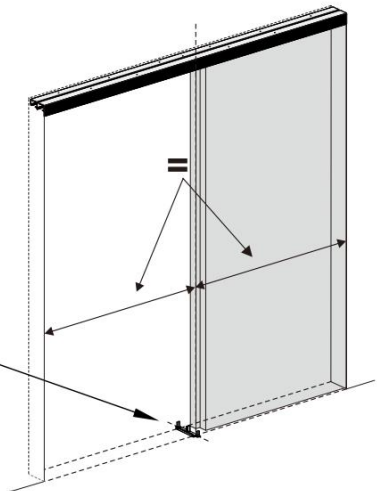
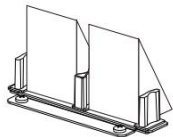

## Installatie

4

**NOTE:** Floor guide installation instruction for 35mm thick wood door :

1

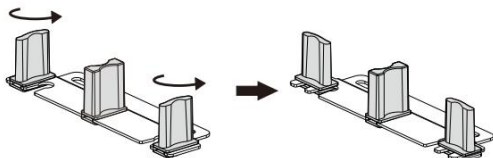

2

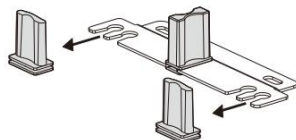

3

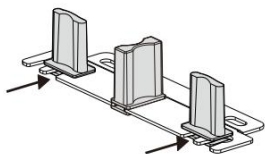

4

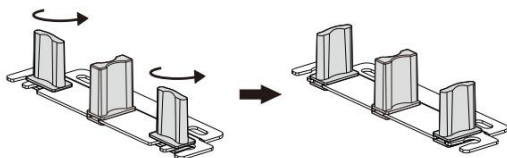

5

### Door Adjustment

Use spanner to adjust door height through adjusting nut of hanger. Doors should plumb with jambs.

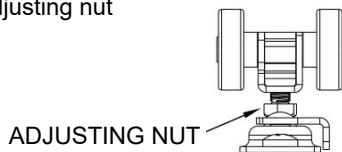

# Installatie

6

D



(x2)



ST4.2x19 (x6)

## Install Door Stop

Attach door stop on the back of front door, 1-1/2"(38mm) from door edge, 1/2"(13mm) from top (Hollow Core doors) or 40"(100mm) from bottom (Solid Core doors). Note: if other than pull is used, adjust location of stop to allow for access to rear door pull.

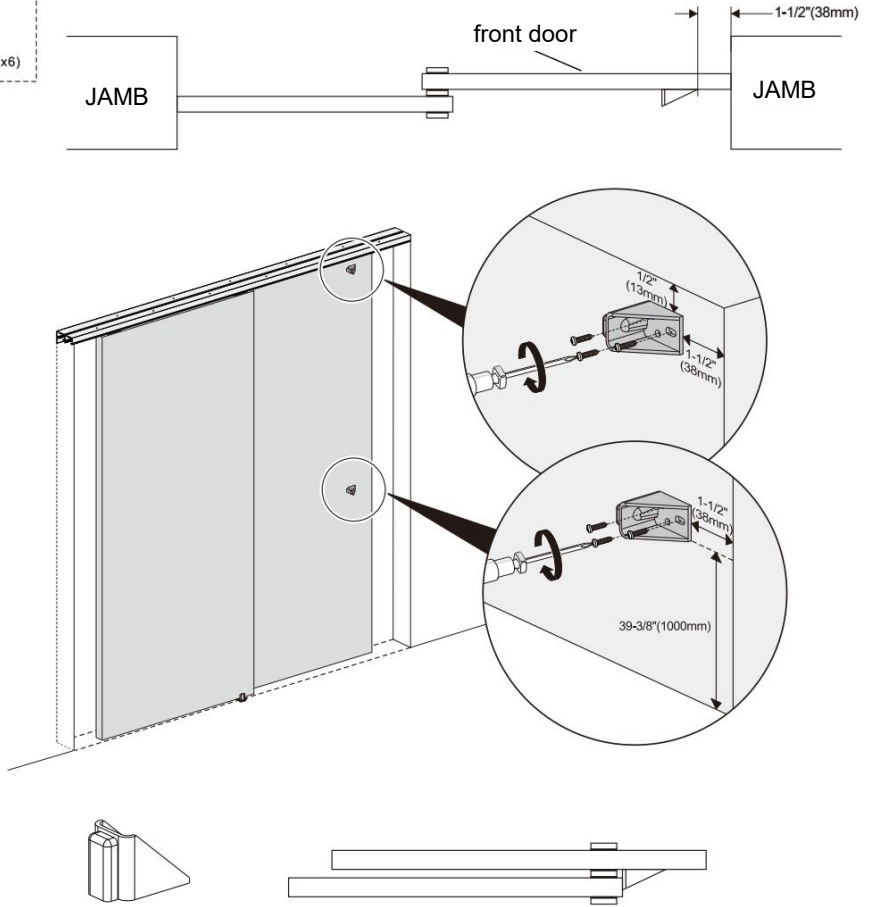

## MAINTENANCE

**4.** Vermijd langdurige blootstelling aan de zon om veroudering te voorkomen.

**Fabrikant:** Shanghaimuxinmuyeyouxiangongsi

**Adres:** Shuangchenglu 803nong11hao1602A-1609shi, baoshanqu, shanghai 200000 CN.

**Geïmporteerd naar AUS:** SIHAO PTY LTD. 1 ROKEVA  
STREETEASTWOOD

NSW 2122 Australië

**Geïmporteerd naar de VS:** Sanven Technology Ltd. Suite 250, 9166  
Anaheim

Plaats, Rancho Cucamonga, CA 91730

|           |            |  |
|-----------|------------|--|
| <b>UK</b> | <b>REP</b> | YH CONSULTING LIMITED. C/O YH Consulting<br>Limited Office 147, Centurion House, London<br>Road, Staines-upon-Thames, Surrey, TW18 4AX |
|-----------|------------|--|

|           |            |  |
|-----------|------------|--|
| <b>EC</b> | <b>REP</b> | E-CrossStu GmbH<br>Mainzer Landstr.69,<br>60329 Frankfurt am Main. |
|-----------|------------|--|



