

# **VEVOR**

**Affordable. Reliable. Home Improvement.**

## **GROW TENT KIT**

**MODEL: HX150150200**

# VEVOR

Affordable. Reliable. Home Improvement.

## GROW TENT KIT

**MODEL: HX150150200**

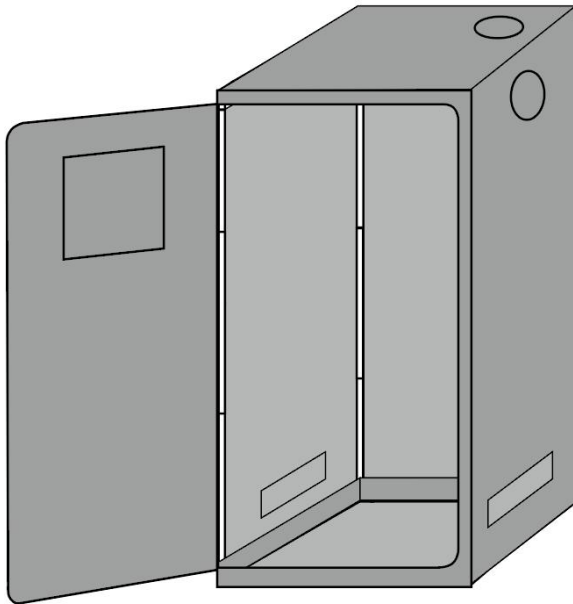



This is the original instruction, please read all manual instructions carefully before operating. VEVOR reserves a clear interpretation of our user manual. The appearance of the product shall be subject to the product you received. Please forgive us that we won't inform you again if there are any technology or software updates on our product.





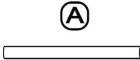

## PRODUCT INSTRUCTIONS

### WARNING:

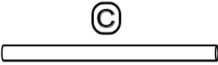
- Please read through all instructions. If grow tent is improperly installed and/or maintained, there is potential for damage or possible injury or death.
- Use extreme care when handling sharp object in or around tent.
- Keep electrical wires safely away from equipment and areas in and or around the tent that may collect water.
- Do not hang equipment on or from grow tent that is above the supported weight range.
- Do not permit children to play on, in, or around grow tent.
- Do not use your grow tent if any part of your tent material is cracked, ripped, or broken.
- Do not place grow tent near a deck, stairs, chair, or other unsafe structure.
- Assemble correctly to avoid tent tipping over and causing injury.
- Do not expose grow tent to direct sunlight, near an open flame, or a heat source.
- Provide proper air circulation in your grow tent to prevent air from going stale.

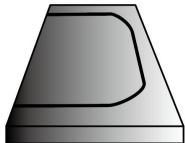
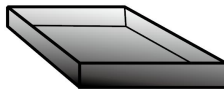
## PARTS LIST

Product Code	HX150150200
Size Parts	150X150X2000cm
 <p style="text-align: center;">(A)</p>	L 1440 mmX8 PCS
 <p style="text-align: center;">(B)</p>	L 980 mmX4 PCS

	L 1000 mmX4 PCS
	L 1450 mmX3 PCS
 <p data-bbox="190 542 246 574">Tent</p>	1 PCS
 <p data-bbox="151 710 285 742">Floor Tray</p>	1 PCS
 <p data-bbox="117 917 319 949">Corner Adapter</p>	8PCS
 <p data-bbox="140 1045 296 1077">Filter Straps</p>	2 PCS
 <p data-bbox="145 1220 308 1292">Support Bar (deep)</p>	2 PCS
 <p data-bbox="140 1388 302 1460">Support Bar (shallow)</p>	4 PCS

## ASSEMBLY STEP

### Installation of the Bracket

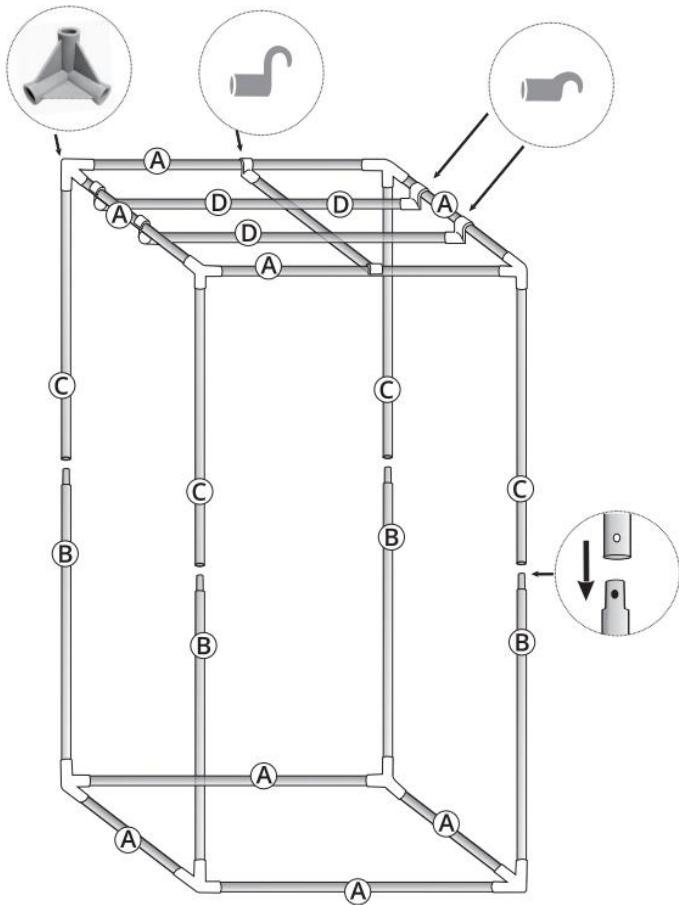

### Installation of the Tent

**STEP1**

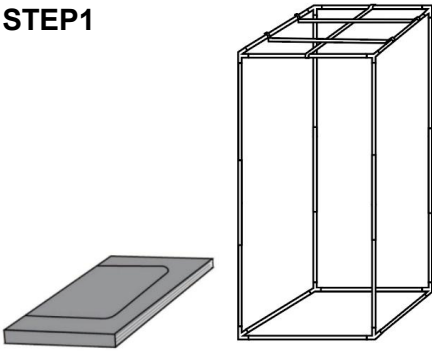

**STEP2**

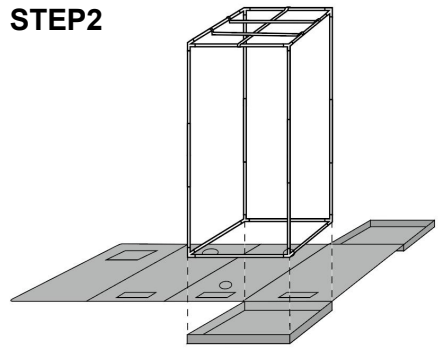

**STEP3**

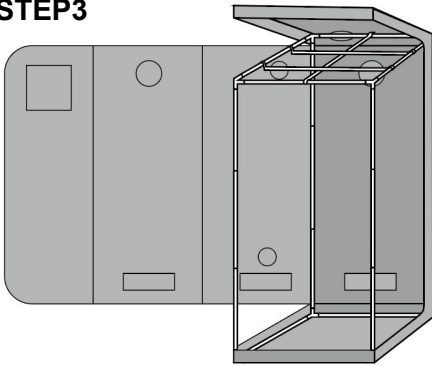

**STEP4**

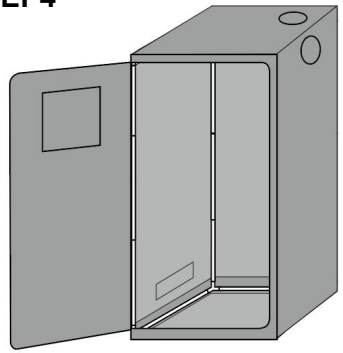

**STEP5**

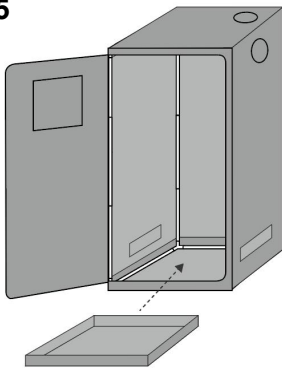

**STEP6**

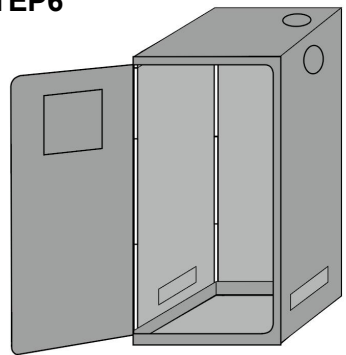



Incorrect operation



Correct operation

If light leakage occurs in a dark environment, smooth out the light barrier at the inner zipper of the tent to improve the light blocking effect.



**Manufacturer:** Shanghaimuxinmuyeyouxiangongsi

**Address:** Shuangchenglu 803nong11hao1602A-1609shi, baoshanqu, shanghai 200000 CN.

**Imported to AUS:** SIHAO PTY LTD. 1 ROKEVA STREETEASTWOOD NSW 2122 Australia

**Imported to USA:** Sanven Technology Ltd. Suite 250, 9166 Anaheim Place, Rancho Cucamonga, CA 91730

<b>UK</b>	<b>REP</b>
-----------	------------

YH CONSULTING LIMITED. C/O YH Consulting Limited Office 147, Centurion House, London Road, Staines-upon-Thames, Surrey, TW18 4AX

<b>EC</b>	<b>REP</b>
-----------	------------

E-CrossStu GmbH  
Mainzer Landstr.69,  
60329 Frankfurt am Main.



# **VEVOR**

**Affordable. Reliable. Home Improvement.**

## **KIT DE TIENDA DE CULTIVO**

**MODELO: HX150150200**

# VEVOR

Affordable. Reliable. Home Improvement.

## GROW TENT KIT

**MODELO: HX150150200**

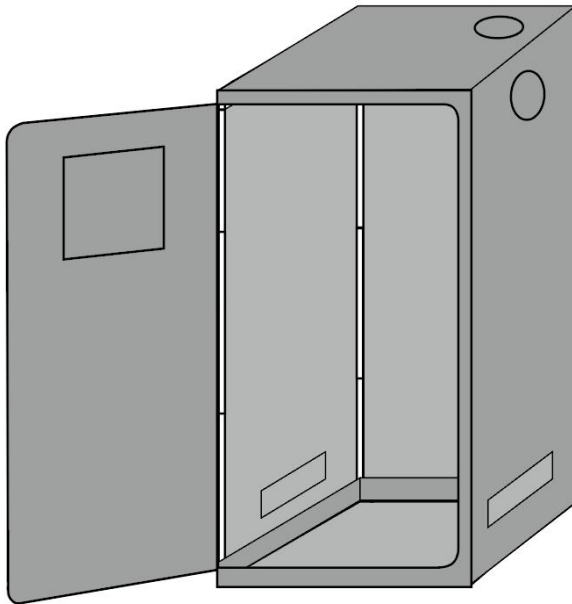

Estas son las instrucciones originales; lea atentamente todas las instrucciones del manual antes de utilizarlo. VEVOR se reserva el derecho de interpretar su manual de usuario. La apariencia del producto dependerá del producto que haya recibido. Le rogamos que nos disculpe si no le informamos de nuevo si hay actualizaciones tecnológicas o de software en nuestro producto.





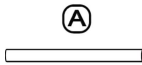

## PRODUCT INSTRUCTIONS

### ADVERTENCIA:

- Lea todas las instrucciones. Si la tienda de cultivo está... incorrectamente instalado y/o mantenido, existe potencial de daño o posible lesión o muerte.
- Tenga mucho cuidado al manipular objetos afilados en o Alrededor de la tienda.
- Mantenga los cables eléctricos lejos del equipo de forma segura. y áreas en y o alrededor de la tienda que pueda recoger agua.
- No cuelgue equipos sobre o desde una carpa de cultivo que esté por encima de la rango de peso soportado.
- No permita que los niños jueguen sobre, dentro o alrededor de tienda de cultivo.
- No utilice su tienda de cultivo si alguna parte de su tienda el material está agrietado, rasgado o roto.
- No coloque la tienda de cultivo cerca de una terraza, escaleras, sillas o otros inseguros estructura.
- Montar correctamente para evitar que la tienda se vuelque y causando lesiones.
- No exponga la tienda de cultivo a la luz solar directa, cerca de un llama abierta o una fuente de calor.
- Proporcione una circulación de aire adecuada en su tienda de cultivo para evitar que el aire se vuelva viciado.

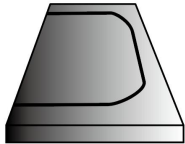
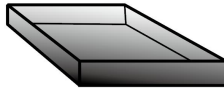
## PARTS LIST

Código de producto	HX150150200
Tamaño	150X150X2000 cm
Regiones	
	Largo 1440 mm X8 PC

 <p style="text-align: center;">(B)</p>	<p style="text-align: center;">Yo 980 mm X 4 PC</p>
 <p style="text-align: center;">(C)</p>	<p style="text-align: center;">Largo 1000 mm X 4 PC</p>
 <p style="text-align: center;">(D)</p>	<p style="text-align: center;">Largo 1450 mm X 3 piezas</p>
 <p style="text-align: center;">Carpa</p>	<p style="text-align: center;">1 pieza</p>
 <p style="text-align: center;">Bandeja de suelo</p>	<p style="text-align: center;">1 pieza</p>
 <p style="text-align: center;">Adaptador de esquina</p>	<p style="text-align: center;">8 piezas</p>
 <p style="text-align: center;">Trampas de filtro S</p>	<p style="text-align: center;">2 piezas</p>
 <p style="text-align: center;">Barra de soporte</p>	<p style="text-align: center;">2 piezas</p>

(profundo)	
 Barra de soporte (superficial)	4 piezas

## ASSEMBLY STEP

### Instalación del soporte

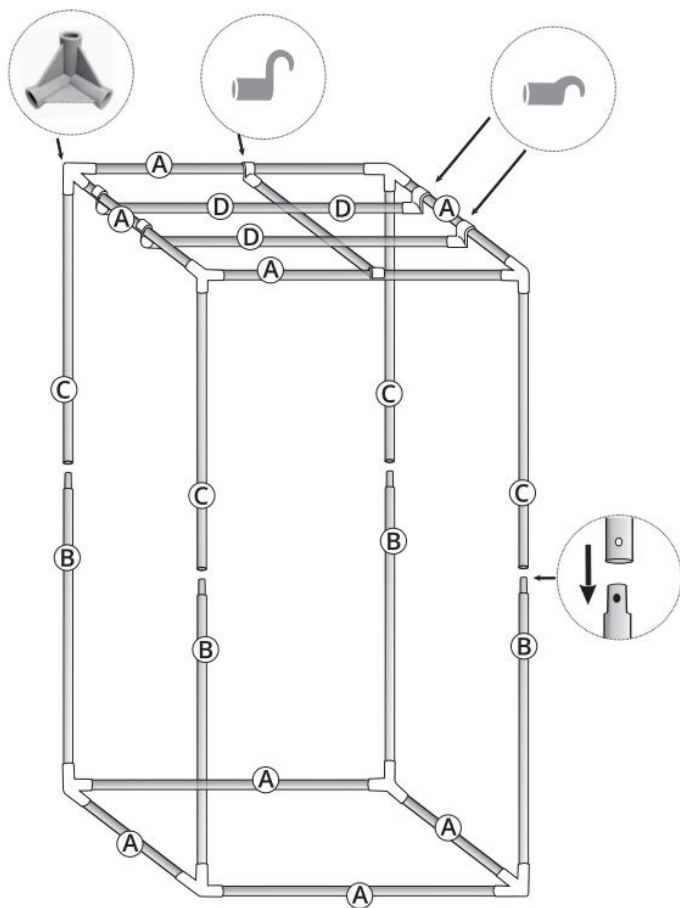

## Instalación de la carpa

**STEP1**

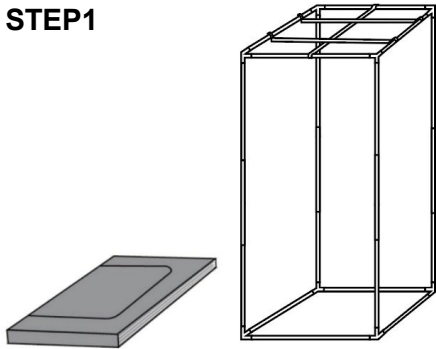

**STEP2**

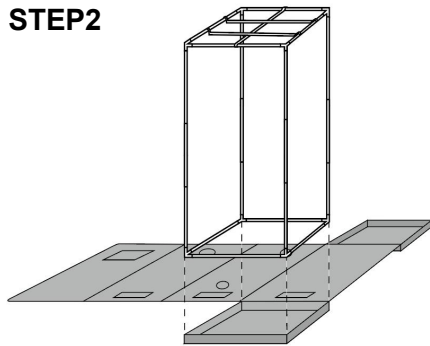

**STEP3**

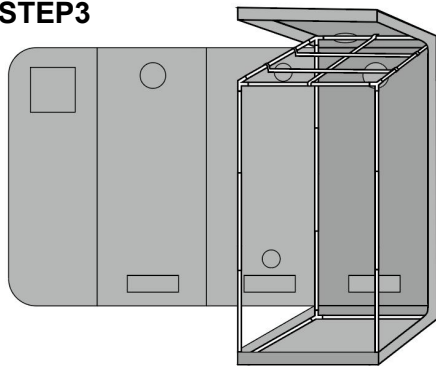

**STEP4**

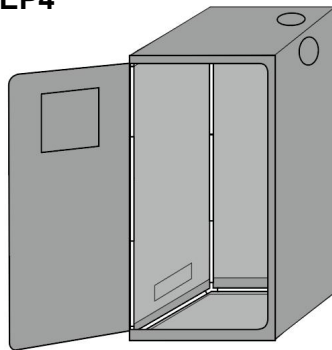

**STEP5**

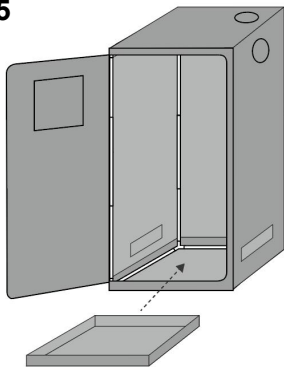

**STEP6**

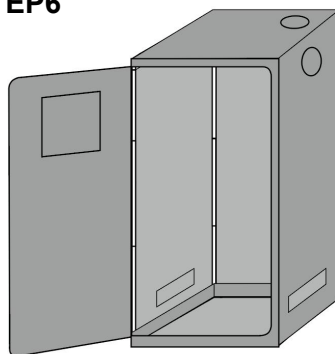



Incorrect operation



Correct operation

If light leakage occurs in a dark environment, smooth out the light barrier at the inner zipper of the tent to improve the light blocking effect.



**Fabricante:** Shanghai muxinmuyeyouxiangongsi

**Dirección:** Shuangchenglu 803nong11hao1602A-1609shi, baoshanqu, Shanghai 200000 CN.

**Importado a AUS:** SIHAO PTY LTD. 1 ROKEVA STREET, EASTWOOD NSW 2122 Australia

**Importado a EE. UU.:** Sanven Technology Ltd. Suite 250, 9166 Anaheim Lugar, Rancho Cucamonga, CA 91730

<b>UK</b>	<b>REP</b>
-----------	------------

YH CONSULTING LIMITED. C/O YH Consulting Limited Office 147, Centurion House, London Road, Staines-upon-Thames, Surrey, TW18 4AX

<b>EC</b>	<b>REP</b>
-----------	------------

E-CrossStu GmbH Mainzer Landstr.69, 60329 Frankfurt am Main.



# **VEVOR**

**Affordable. Reliable. Home Improvement.**

## **ODLINGSTÄLTKIT**

**MODELL: HX150150200**

# VEVOR

Affordable. Reliable. Home Improvement.

## GROW TENT KIT

**MODELL: HX150150200**

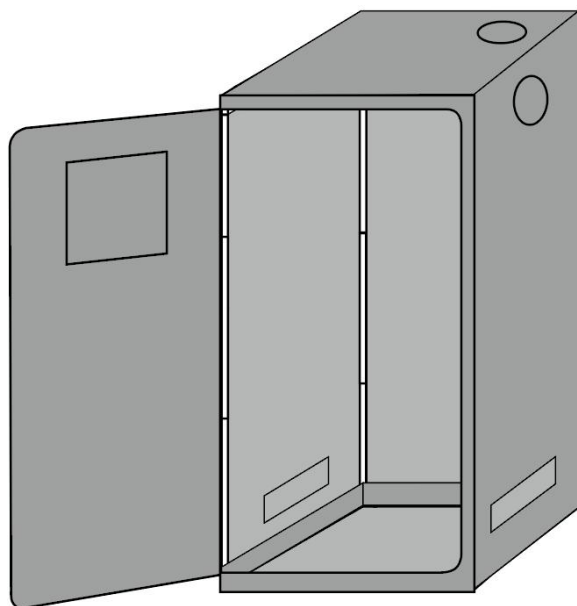



Detta är originalinstruktionerna, vänligen läs alla instruktioner noggrant innan du använder produkten. VEVOR förbehåller sig en tydlig tolkning av vår användarmanual. Produktens utseende ska vara beroende av den produkt du mottagit. Vi ber om ursäkt för att vi inte kommer att informera dig igen om det finns några teknik- eller programuppdateringar för vår produkt.







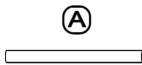

## PRODUCT INSTRUCTIONS

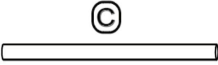
### VARNING:

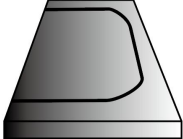
- Läs igenom alla instruktioner. Om odlingstältet är otillbörligt installerat och/eller underhållet, finns det risk för skada eller eventuell personskada eller dödsfall.
- Var extremt försiktig vid hantering av vassa föremål i eller runt tältet.
- Håll elkablar säkert borta från utrustning och områden i och eller runt tältet som kan samla vatten.
- Häng inte utrustning på eller från odlingstält som är ovanför stödt viktintervall.
- Låt inte barn leka på, i eller runt odlingstält.
- Använd inte ditt odlingstält om någon del av ditt tält materialet är sprucket, sönderripen eller trasig.
- Placera inte odlingstältet nära en altan, trappa, stol eller andra osäkra strukturera.
- Montera tältet korrekt för att undvika att det välter. orsakar skada.
- Utsätt inte odlingstältet för direkt solljus, nära en öppen låga eller en värmekälla.
- Sörj för ordentlig luftcirkulation i ditt odlingstält för att förhindra att luften blir tråkig.

## PARTS LIST

Produktkod	HX150150200
Delar	Storlek 150X150X2000 cm
	L 1440 mm x 8 PCS
	L 980 4 mm X 10 mm PCS

 <p style="text-align: center;">C</p>	<p style="text-align: center;">Längd 1000 mm X 4 PCS</p>
 <p style="text-align: center;">D</p>	<p style="text-align: center;">L 1450 mm X 3 ST</p>
 <p style="text-align: center;">Tält</p>	<p style="text-align: center;">1 st</p>
 <p>Golvbricka</p>	<p style="text-align: center;">1 st</p>
 <p>Hörnadapter</p>	<p style="text-align: center;">8 st</p>
 <p>Filter S - fällor</p>	<p style="text-align: center;">2 st</p>
 <p>Stödbar (djup)</p>	<p style="text-align: center;">2 st</p>
 <p>Stödstång ( grund )</p>	<p style="text-align: center;">4 st</p>

## ASSEMBLY STEP

### Installation av fästet

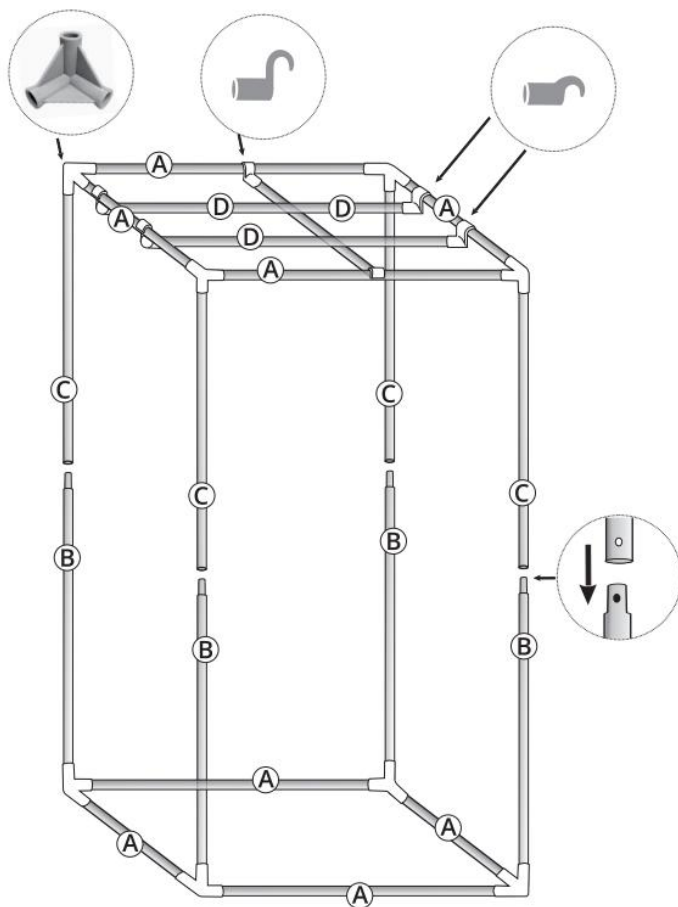

### Installation av tältet

**STEP1**

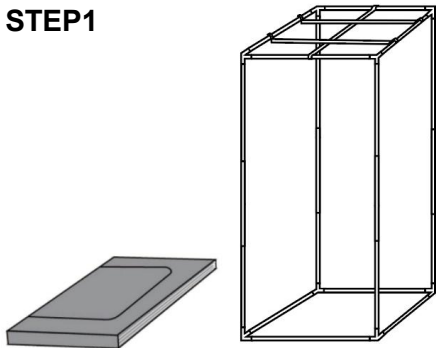

**STEP2**

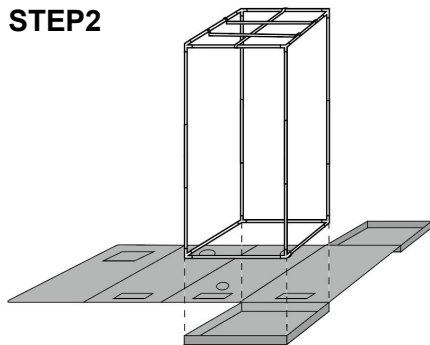

**STEP3**

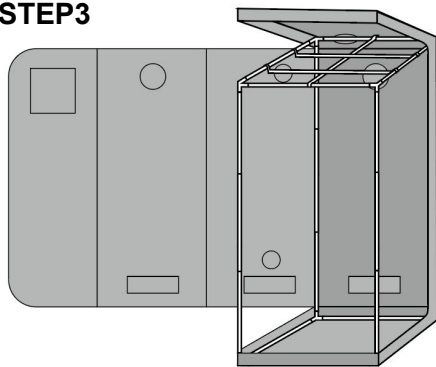

**STEP4**

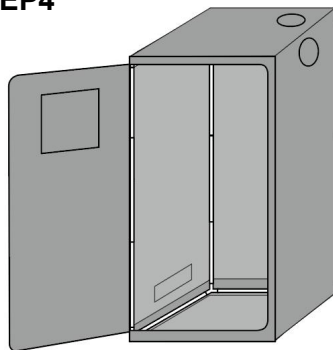

**STEP5**

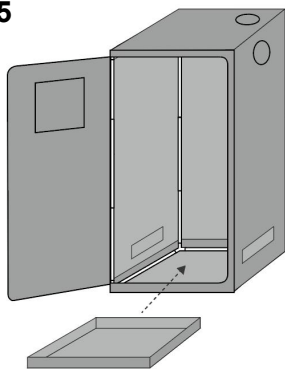

**STEP6**

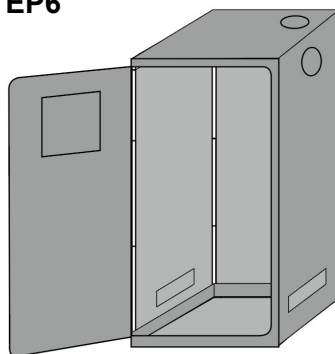



Incorrect operation



Correct operation

If light leakage occurs in a dark environment, smooth out the light barrier at the inner zipper of the tent to improve the light blocking effect.



**Tillverkare:** Shanghaimuxinmuyeyouxiangongsi

**Address:** Shuangchenglu 803nong11hao1602A-1609shi, baoshanqu, Shanghai 200 000 kanadensiska republiken.

**Importerad till Australien:** SIHAO PTY LTD. 1 ROKEVA STREETEASTWOOD NSW 2122 Australien

**Importerad till USA:** Sanven Technology Ltd. Suite 250, 9166 Anaheim Plats, Rancho Cucamonga, Kalifornien 91730

<b>UK</b>	<b>REP</b>
-----------	------------

YH CONSULTING LIMITED. C/O YH Consulting Limited Office 147, Centurion House, London Road, Staines-upon-Thames, Surrey, TW18 4AX

<b>EC</b>	<b>REP</b>
-----------	------------

E-CrossStu GmbH Mainzer Landstr.69, 60329 Frankfurt am Main.



# **VEVOR**

**Affordable. Reliable. Home Improvement.**

## **KWEEKTENT KIT**

**MODEL: HX150150200**

# VEVOR

Affordable. Reliable. Home Improvement.

## GROW TENT KIT

**MODEL: HX150150200**

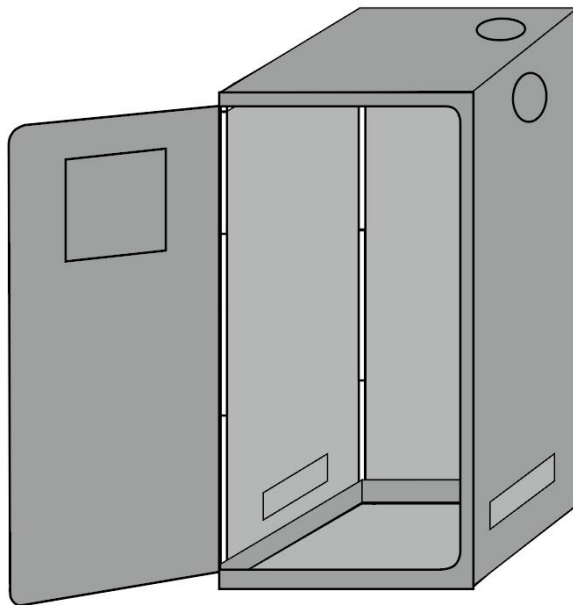

Dit is de originele handleiding. Lees alle instructies zorgvuldig door voordat u het product gebruikt. VEVOR behoudt zich het recht voor om de gebruiksaanwijzing duidelijk te interpreteren. Het uiterlijk van het product is afhankelijk van het product dat u hebt ontvangen. Neemt u het ons niet kwalijk dat we u niet meer op de hoogte stellen van eventuele technologische of software-updates voor ons product.





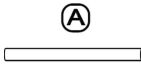

## PRODUCT INSTRUCTIONS

### WAARSCHUWING:

- Lees alle instructies aandachtig door. Als de kweektent is onjuist geïnstalleerd en/of onderhouden, is er kans op schade of mogelijk letsel of overlijden.
- Wees uiterst voorzichtig bij het hanteren van scherpe voorwerpen in of rond de tent.
- Houd elektrische draden veilig uit de buurt van apparatuur en gebieden in en of rond de tent die misschien water verzamelen.
- Hang geen apparatuur aan of op een kweektent die boven de ondersteund gewichtsbereik.
- Laat kinderen niet op, in of rond de speelplaats spelen. kweektent.
- Gebruik uw kweektent niet als een deel van uw tent beschadigd is. materiaal is gebarsten, gescheurd of gebroken.
- Plaats de kweektent niet in de buurt van een terras, trap, stoel of andere onveilige structuur.
- Monteer de tent op de juiste manier om te voorkomen dat deze omvalt en letsel veroorzaken.
- Stel de kweektent niet bloot aan direct zonlicht, in de buurt van een open vuur of een warmtebron.
- Zorg voor een goede luchtcirculatie in uw kweektent om voorkomen dat de lucht muff wordt.

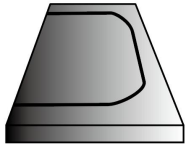
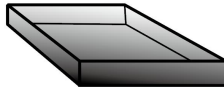
## PARTS LIST

Productcode	HX150150200
Maat	150X150X2000 cm
Onderdelen	
	L 1440 mm X8 PCS

 <p style="text-align: center;">Ⓑ</p>	<p style="text-align: center;">L 980 mm X 4 PCS</p>
 <p style="text-align: center;">Ⓒ</p>	<p style="text-align: center;">Lengte 1000 mm X 4 PCS</p>
 <p style="text-align: center;">Ⓓ</p>	<p style="text-align: center;">L 1450 mm X 3 stuks</p>
 <p style="text-align: center;">T ent</p>	<p style="text-align: center;">1 STUKS</p>
 <p style="text-align: center;">Vloerbak</p>	<p style="text-align: center;">1 STUKS</p>
 <p style="text-align: center;">Hoekadapter</p>	<p style="text-align: center;">8 stuks</p>
 <p style="text-align: center;">Filtervallen</p>	<p style="text-align: center;">2 stuks</p>
 <p style="text-align: center;">Ondersteuningsba lk (diep)</p>	<p style="text-align: center;">2 stuks</p>



Steunbalk  
( ondiep )

4 stuks

## ASSEMBLY STEP

**Installatie van de beugel**

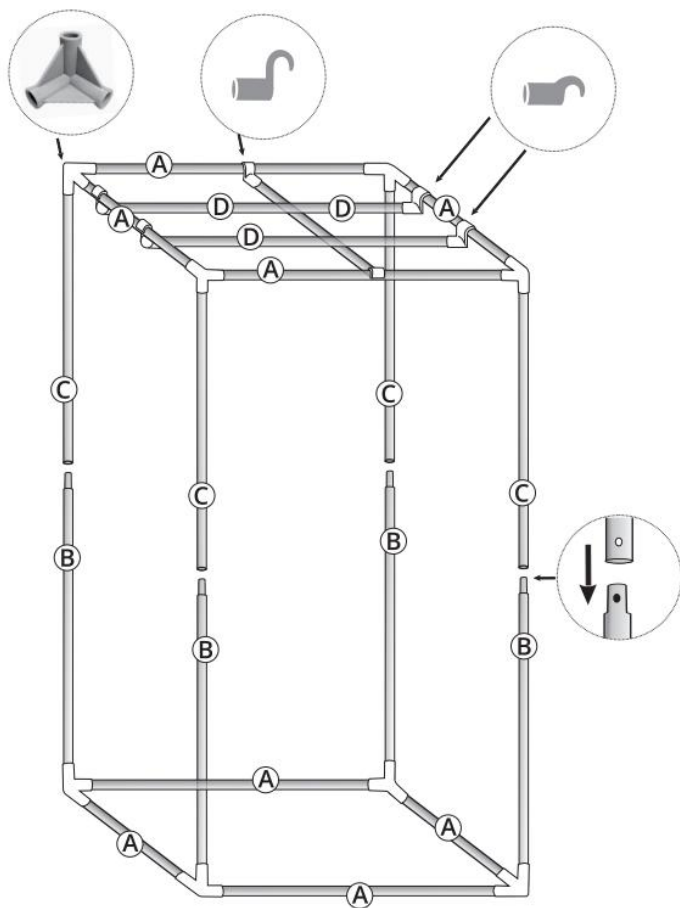

## Installatie van de tent

**STEP1**

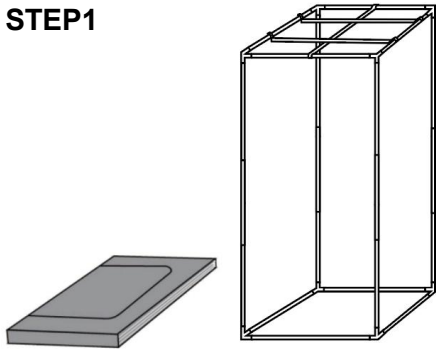

**STEP2**

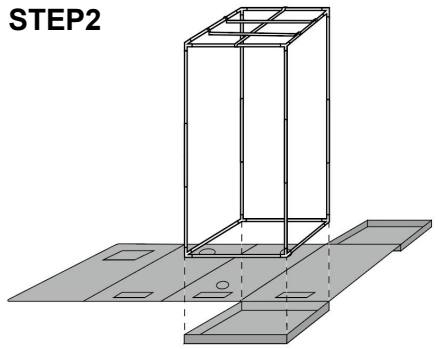

**STEP3**

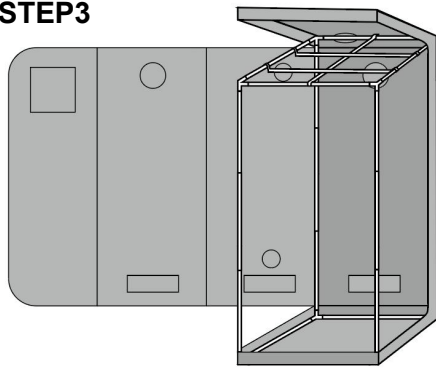

**STEP4**

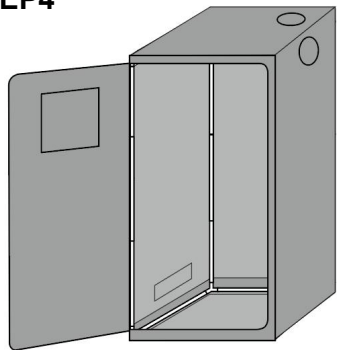

**STEP5**

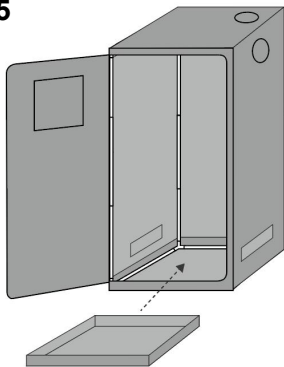

**STEP6**

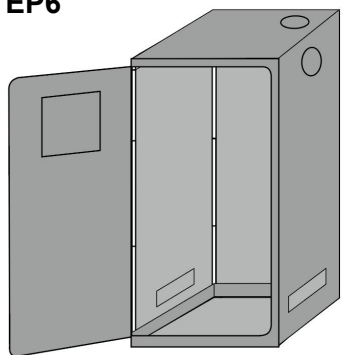



Incorrect operation



Correct operation

If light leakage occurs in a dark environment, smooth out the light barrier at the inner zipper of the tent to improve the light blocking effect.



**Fabrikant:** Shanghaimuxinmuyeyouxiangongsi

**Adres:** Shuangchenglu 803nong11hao1602A-1609shi, baoshanqu, shanghai 200000 CN.

**Geïmporteerd naar AUS:** SIHAO PTY LTD. 1 ROKEVA  
STREETEASTWOOD  
NSW 2122 Australië

**Geïmporteerd naar de VS:** Sanven Technology Ltd. Suite 250, 9166  
Anaheim  
Plaats, Rancho Cucamonga, CA 91730

<b>UK</b>	<b>REP</b>
-----------	------------

YH CONSULTING LIMITED. C/O YH Consulting  
Limited Office 147, Centurion House, London  
Road, Staines-upon-Thames, Surrey, TW18 4AX

<b>EC</b>	<b>REP</b>
-----------	------------

E-CrossStu GmbH  
Mainzer Landstr.69,  
60329 Frankfurt am Main.

