

VEVOR

Upgrade · The Home Creator Way

Expandable Metal Barricade

MODEL:XSJ-S-0008/XSJ-S-0009

MODEL:XSJ-S-0008/XSJ-S-0009

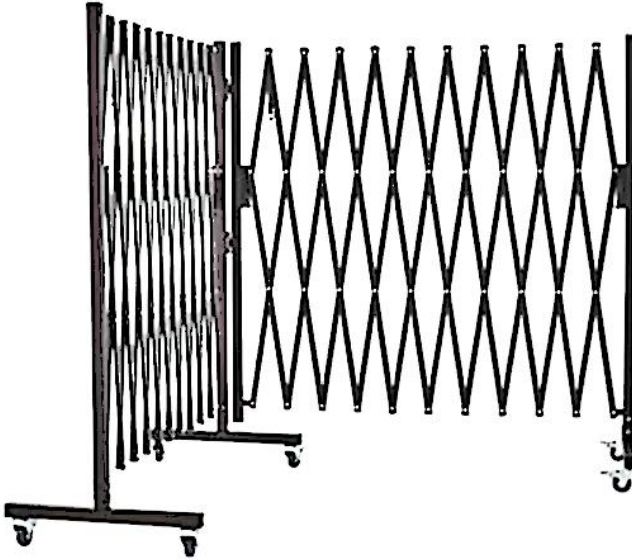

Video installation QR code

This is the original instruction, please read all manual instructions carefully before operating. VEVOR reserves a clear interpretation of our user manual. The appearance of the product shall be subject to the product you received. Please forgive us that we won't inform you again if there are any technology or software updates on our product.

SAFETY INSTRUCTIONS

WARNING:

Read this material before using this product. Failure to do so can result in serious injury.

Assembly precautions







1. Assemble only according to these instructions. Improper assembly can create hazards.
2. Wear ANSI-approved safety goggles and heavy-duty work gloves during assembly.
3. Keep the assembly area clean and well-lit.
4. Keep bystanders out of the area during assembly.
5. Do not assemble if tired or when under the influence of alcohol, drugs or medication.
6. The product capabilities apply to properly and completely assembled products only.
7. For additional information regarding the parts listed in the following pages, please refer to the Assembly Diagram of this manual. Unwrap and separate all parts in a clean work area.
8. Using an electric screwdriver can effectively improve product installation efficiency. The product accessories include sandbags, which can effectively enhance the stability of the product.

Use precautions

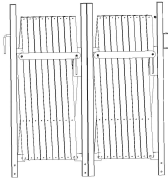
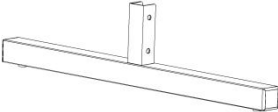
1. DO NOT SIT OR STAND ON THIS ITEM.
2. This product is not a toy. Do not allow children to play with or near this item.
3. Do not exceed specified weight capacities.
4. Use as intended only.
5. Inspect before every use; do not use if parts are loose or damaged.

SAVE THIS MANUAL

PARTS LIST

Item No.	Image	Qty
1		×1
2		×3
3		×6
4		×6
5		×6
6		×1
7		×1
8		×4

EXPLODED VIEW

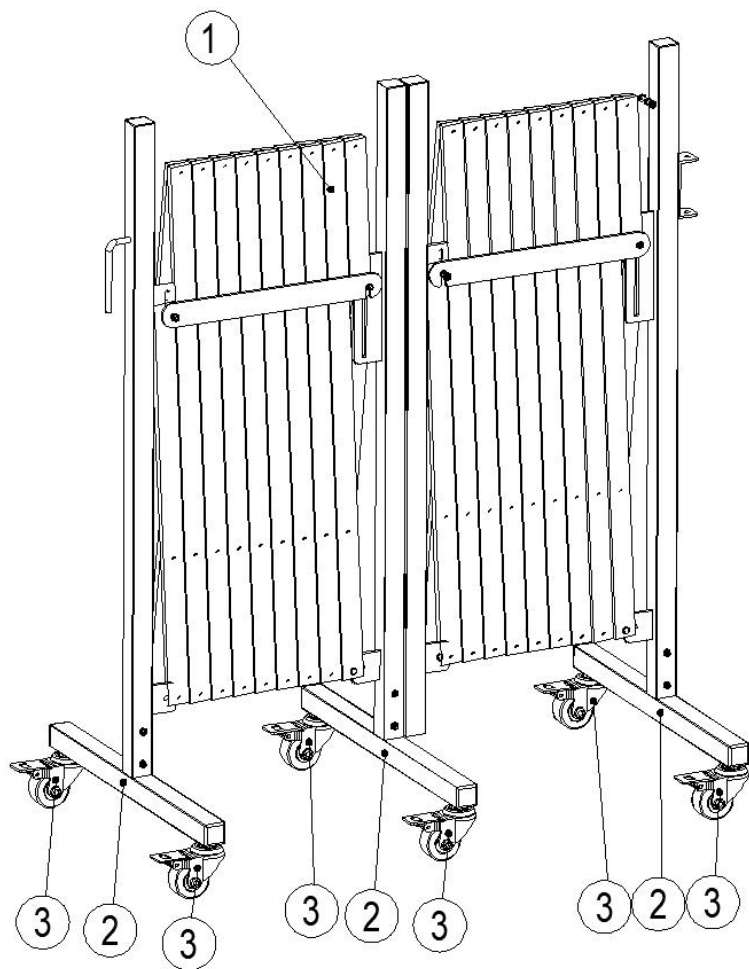



TOOLS



ASSEMBLY



1

			
2	X3	3	X6

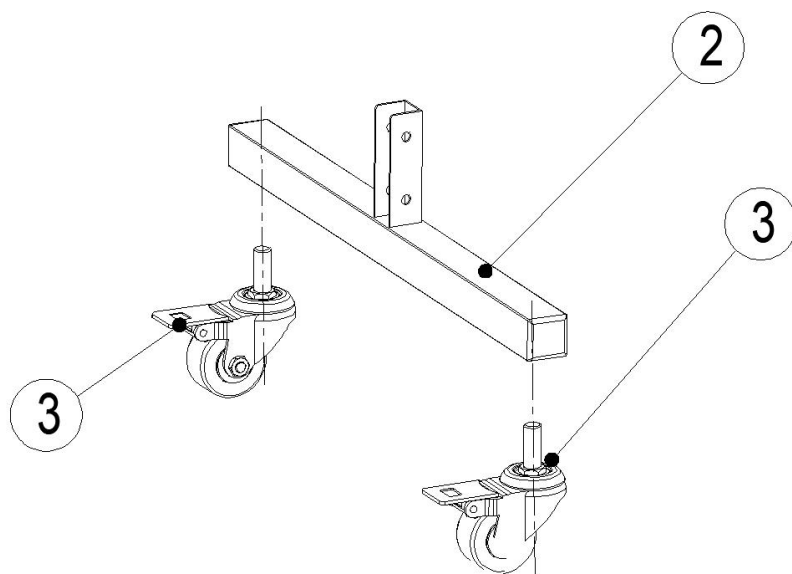
X3



2

					
1	X1	4	X6	5	X6

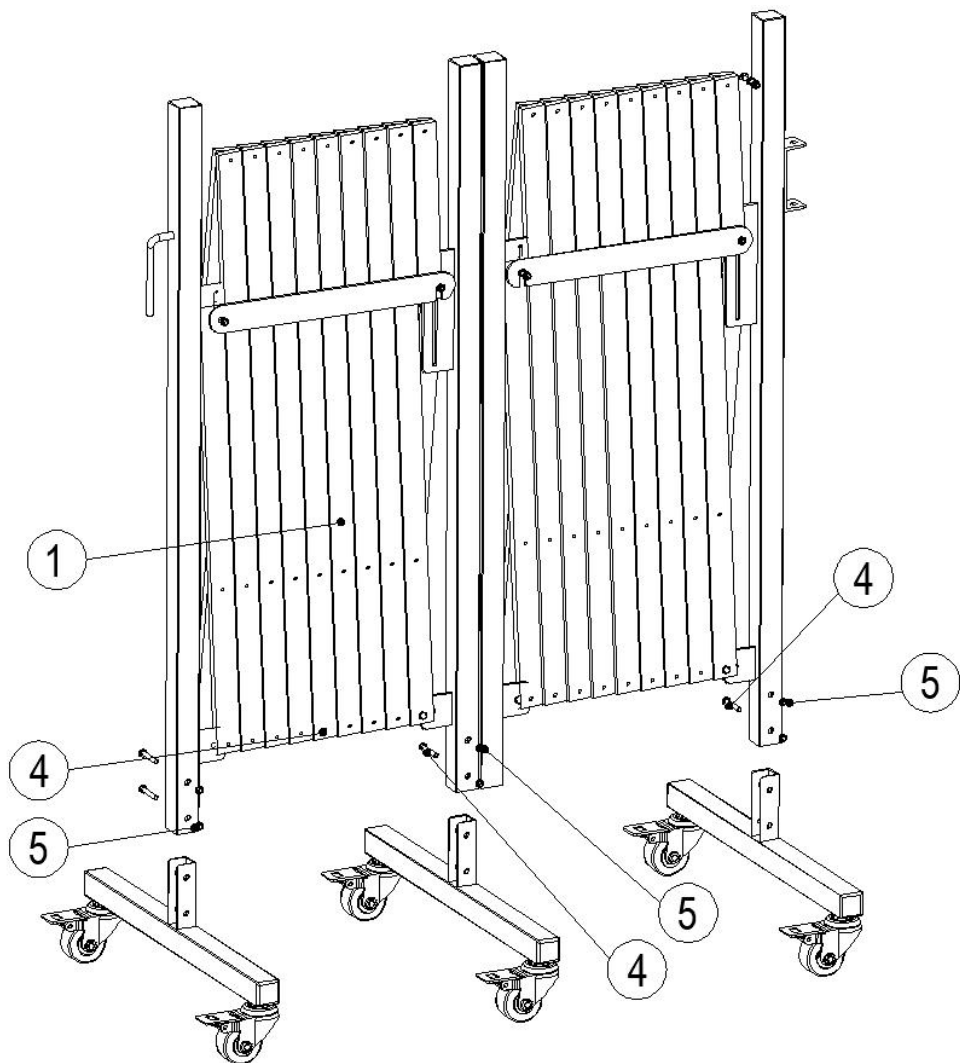

3

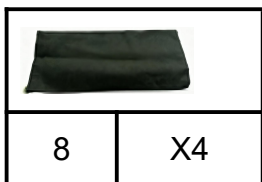

Note

When fully expanded, fill the sandbags with sand and place them on the crossbars at both ends to enhance stability.

PRODUCT PARAMETER

Model	XSJ-S-0008	XSJ-S-0009
Colour	White	Brown
Material	Carbon steel + Aluminum alloy	Carbon steel + Aluminum alloy

Manufacturer: Shanghaimuxinmuyeyouxiangongsi

Address: Shuangchenglu 803nong11hao1602A-1609shi, baoshanqu, shanghai 200000 CN.

Imported to AUS: SIHAO PTY LTD. 1 ROKEVA STREETEASTWOOD NSW 2122 Australia

Imported to USA: Sanven Technology Ltd. Suite 250, 9166 Anaheim Place, Rancho Cucamonga, CA 91730

EC	REP
-----------	------------

E-CrossStu GmbH

Mainzer Landstr.69,60329 Frankfurt am Main.

e-crossstu@outlook.com Tel: +49 69332967674

UK	REP
-----------	------------

YH CONSULTING LIMITED. C/O YH Consulting

Limited Office 147, Centurion House, London Road, Staines-upon-Thames, Surrey, TW18 4AX

H2YHUK@gmail.com Tel.: +44 07514-677868



VEVOR

Upgrade · The Home Creator Way

Ausziehbare Metallbarrikade

MODELL: XSJ-S-0008/XSJ-S-0009

MODELL: XSJ-S-0008/XSJ-S-0009

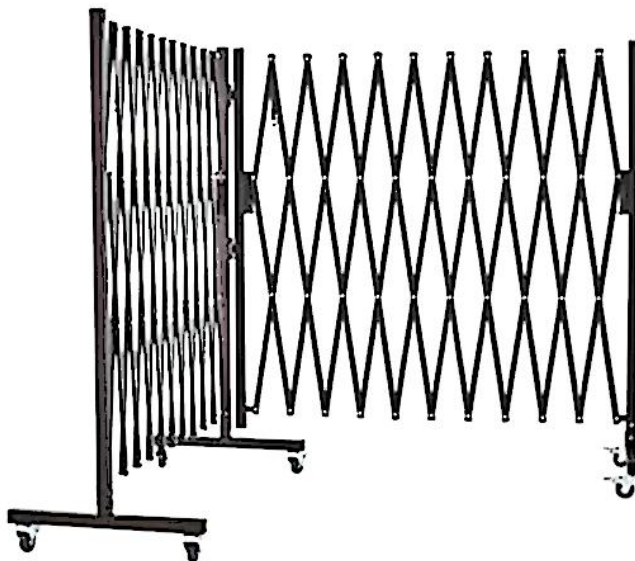

QR-Code für Videoinstallation

Dies ist die Originalanleitung. Bitte lesen Sie die gesamte Bedienungsanleitung vor der Inbetriebnahme sorgfältig durch. VEVOR behält sich die Auslegung der Bedienungsanleitung vor. Das Aussehen des Produkts kann von dem gelieferten Produkt abweichen. Wir bitten um Verständnis, dass wir Sie nicht erneut über etwaige Technologie- oder

SAFETY INSTRUCTIONS

WARNUNG:

Lesen Sie diese Hinweise vor der Verwendung dieses Produkts. Andernfalls kann es zu schweren Verletzungen kommen.

Vorsichtsmaßnahmen bei Versammlungen

9. Bitte montieren Sie das Produkt ausschließlich gemäß dieser Anleitung. Eine unsachgemäße Montage kann Gefahren bergen.
10. Tragen Sie während der Montage eine ANSI-geprüfte Schutzbrille und robuste Arbeitshandschuhe.
11. Halten Sie den Montagebereich sauber und gut beleuchtet.
12. Halten Sie Umstehende während der Versammlung vom Versammlungsort fern.
13. Nicht montieren, wenn Sie müde sind oder unter dem Einfluss von Alkohol, Drogen oder Medikamenten stehen.
14. Die Produkteigenschaften gelten nur für ordnungsgemäß und vollständig montierte Produkte.
15. Weitere Informationen zu den auf den folgenden Seiten aufgeführten Teilen finden Sie in der Montagezeichnung dieses Handbuchs. Packen Sie alle Teile in einem sauberen Arbeitsbereich aus und trennen Sie sie.
16. Die Verwendung eines elektrischen Schraubendrehers kann die Effizienz der Produktinstallation deutlich verbessern. Zum Produktzubehör gehören Sandsäcke, die die Stabilität des Produkts effektiv erhöhen.

Vorsicht walten lassen





6. AUF DIESEM GEGENSTAND SITZEN ODER STEHEN NICHT.
7. Dieses Produkt ist kein Spielzeug. Kinder dürfen nicht mit diesem Artikel spielen oder sich in dessen Nähe aufhalten.
8. Die angegebenen Werte dürfen nicht überschritten werden. Tragfähigkeiten.

9. Nur bestimmungsgemäß verwenden.

10. Vor jedem Gebrauch prüfen; nicht verwenden, wenn Teile lose oder beschädigt sind.

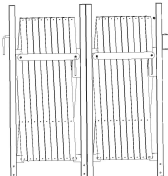
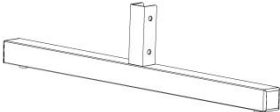
BEWAHREN SIE DIESES HANDBUCH AUF

PARTS LIST

Artikelnummer	Bild	Menge
1		× 1
2		× 3
3		× 6
4		× 6
5		× 6
6		× 1

7		× 1
8		× 4

EXPLODED VIEW

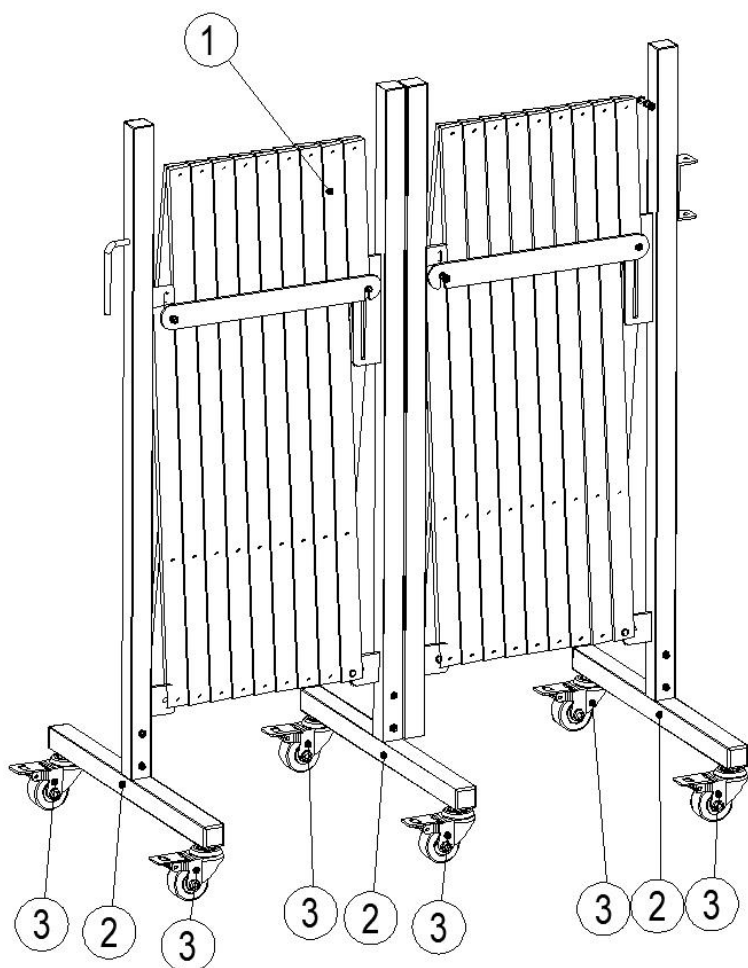

TOOLS



ASSEMBLY



1

2	X 3	3	X 6

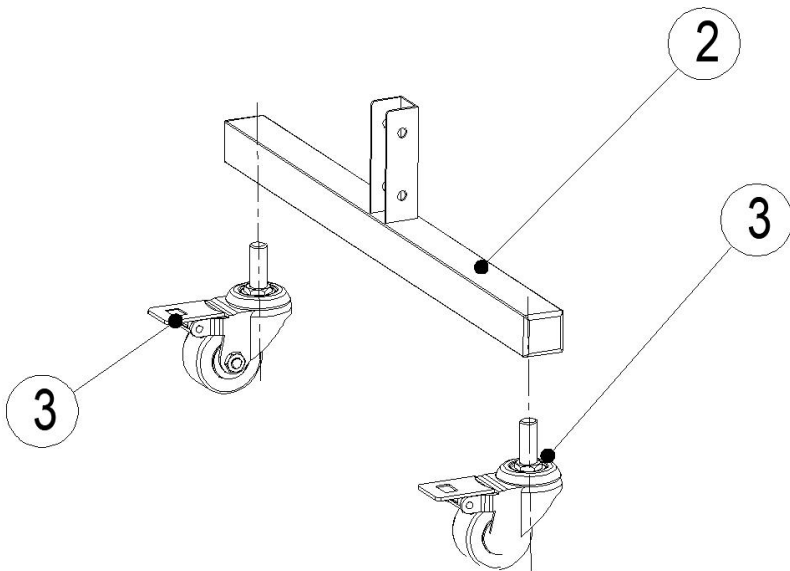
X3



2

					
1	X 1	4	X 6	5	X 6

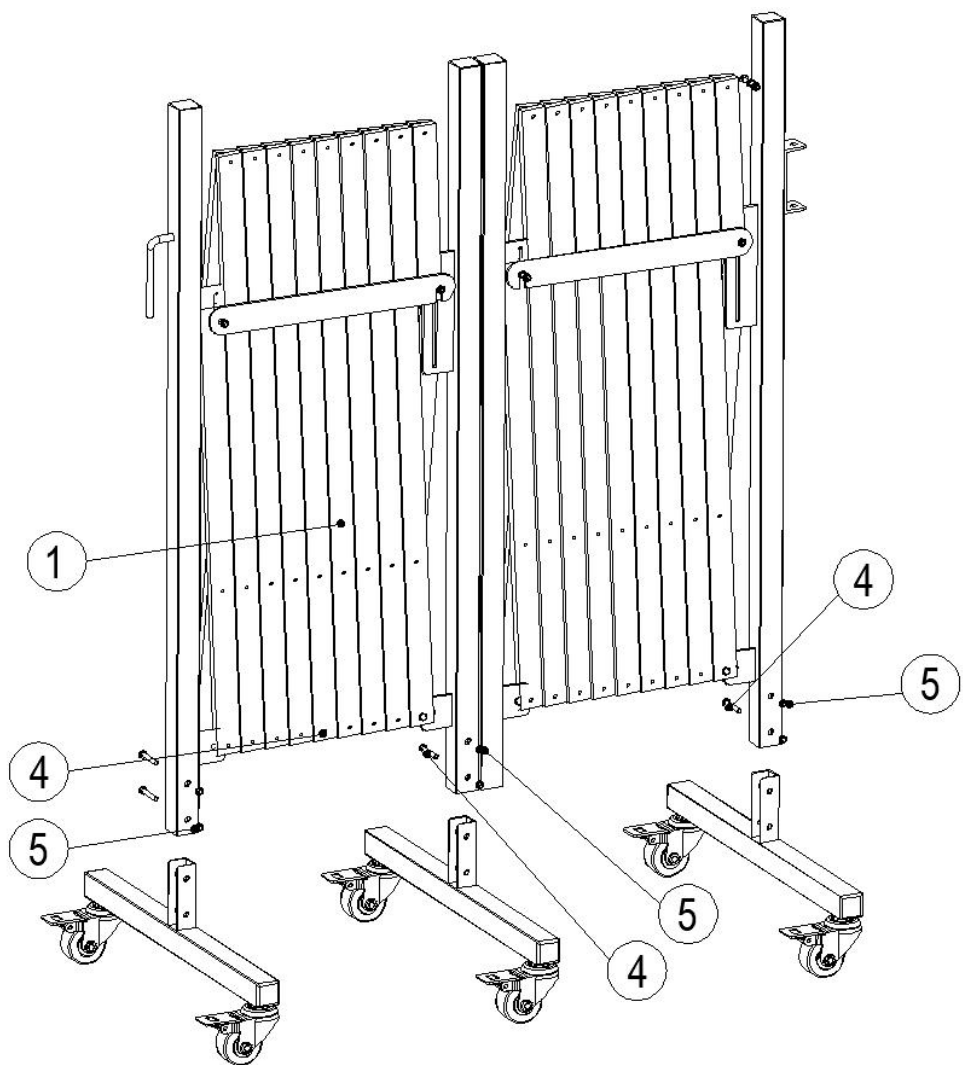

3

	
8	X 4



■ Note

When fully expanded, fill the sandbags with sand and place them on the crossbars at both ends to enhance stability.

PRODUCT PARAMETER

Modell	XSJ-S-0008	XSJ-S-0009
---------------	------------	------------

Farbe	Weiß	Braun
Material	Kohlenstoffstahl + eine Aluminiumlegierung	Kohlenstoffstahl + eine Aluminiumlegierung

Hersteller: Shanghai muxinmuyeyouxiangongsi

Adresse: Shuangchenglu 803nong11hao1602A-1609shi, baoshanqu, Shanghai 200000 CN.

Importiert nach Australien: SIHAO PTY LTD. 1 ROKEVA STREET, EASTWOOD
NSW 2122 Australien

Importiert in die USA: Sanven Technology Ltd. Suite 250, 9166 Anaheim Ort, Rancho Cucamonga, CA 91730

EC	REP
-----------	------------

E-CrossStu GmbH
Mainzer Landstr.69,60329 Frankfurt am Main.
e-crossstu@outlook.com Tel: +49 69332967674

UK	REP
-----------	------------

YH CONSULTING LIMITED. C/O YH Consulting
Limited Office 147, Centurion House, London
Road, Staines-upon-Thames, Surrey, TW18 4AX
H2YHUK@gmail.com Tel.: +44 07514-677868



VEVOR

Upgrade · The Home Creator Way

Barricade métallique extensible

MODÈLE : XSJ-S-0008/XSJ-S-0009

MODÈLE : XSJ-S-0008/XSJ-S-0009

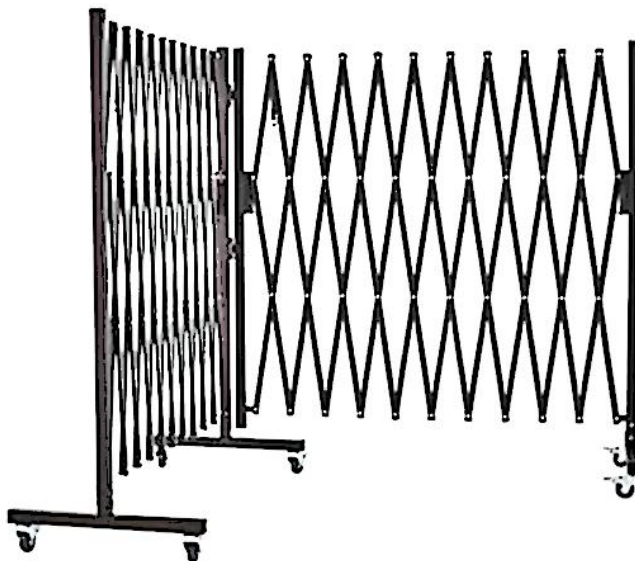

Code QR d'installation vidéo

Voici le mode d'emploi original. Veuillez lire attentivement toutes les instructions du manuel avant utilisation. VEVOR se réserve le droit d'interpréter ce manuel à sa guise. L'apparence du produit que vous recevrez peut différer. Nous vous prions de nous excuser si nous ne vous informons pas des mises à jour techniques ou logicielles concernant notre

produit.

SAFETY INSTRUCTIONS

AVERTISSEMENT:

Veillez lire attentivement cette notice avant d'utiliser ce produit. Le non-respect de cette consigne peut entraîner des blessures graves.

précautions d'assemblage

17. Assembler uniquement selon ces instructions. Un assemblage incorrect peut engendrer des risques.
18. Portez des lunettes de sécurité homologuées ANSI et des gants de travail robustes pendant l'assemblage.
19. Maintenez la zone de rassemblement propre et bien éclairée.
20. Tenir les curieux à l'écart de la zone pendant le rassemblement.
21. Ne pas assembler en cas de fatigue ou sous l'influence de l'alcool, de drogues ou de médicaments.
22. Les capacités du produit s'appliquent uniquement aux produits correctement et entièrement assemblés.
23. Pour plus d'informations concernant les pièces mentionnées dans les pages suivantes, veuillez vous référer au schéma de montage de ce manuel. Déballez et séparez toutes les pièces dans un espace de travail propre.
24. L'utilisation d'un tournevis électrique permet d'améliorer considérablement l'efficacité de l'installation du produit. Les accessoires fournis comprennent des sacs de sable, qui contribuent à renforcer la stabilité du produit.







Prenez des précautions

11. NE PAS S'ASSEOIR NI SE TENIR DEBOUT SUR CET OBJET.
12. Ce produit n'est pas un jouet. Ne laissez pas les enfants jouer avec ou à proximité de cet article.
13. Ne pas dépasser les spécifications capacités de poids.
14. Utiliser uniquement conformément à l'usage prévu.
15. Inspecter avant chaque utilisation ; ne pas utiliser si des pièces sont

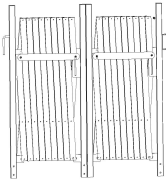
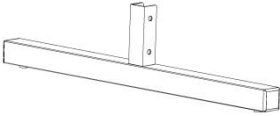
desserrées ou endommagées.

CONSERVEZ CE MANUEL

PARTS LIST

Numéro d'article	Image	Qté
1		× 1
2		× 3
3		× 6
4		× 6
5		× 6
6		× 1
7		× 1

8		× 4
---	-----------------------------------------------------------------------------------	-----

EXPLODED VIEW

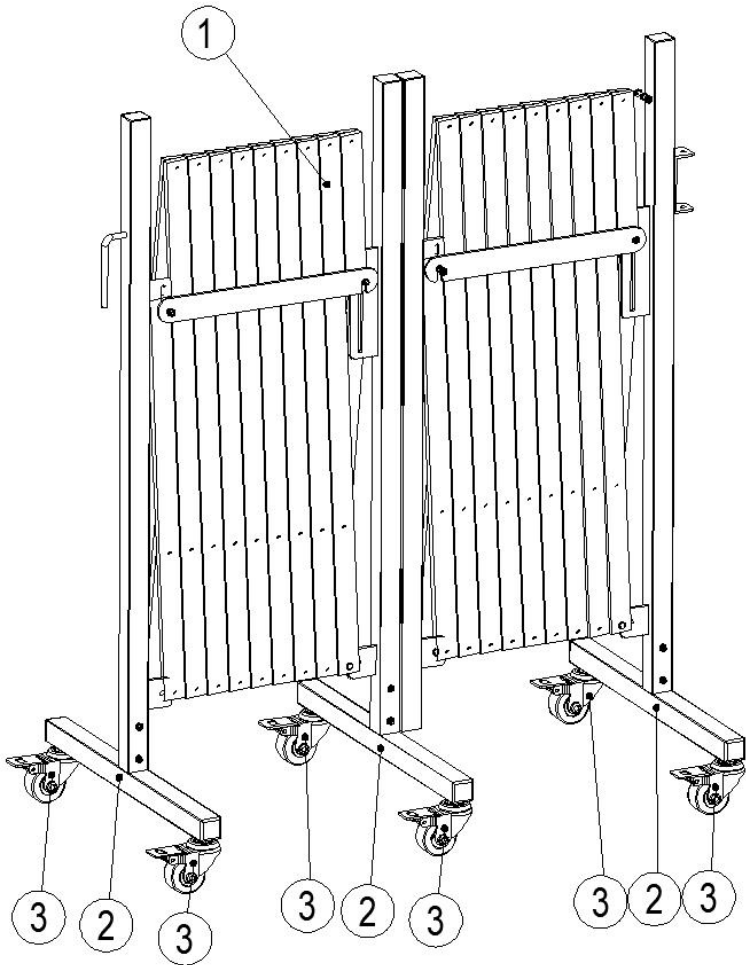



TOOLS



ASSEMBLY



1

	
2	X 3
3	X 6

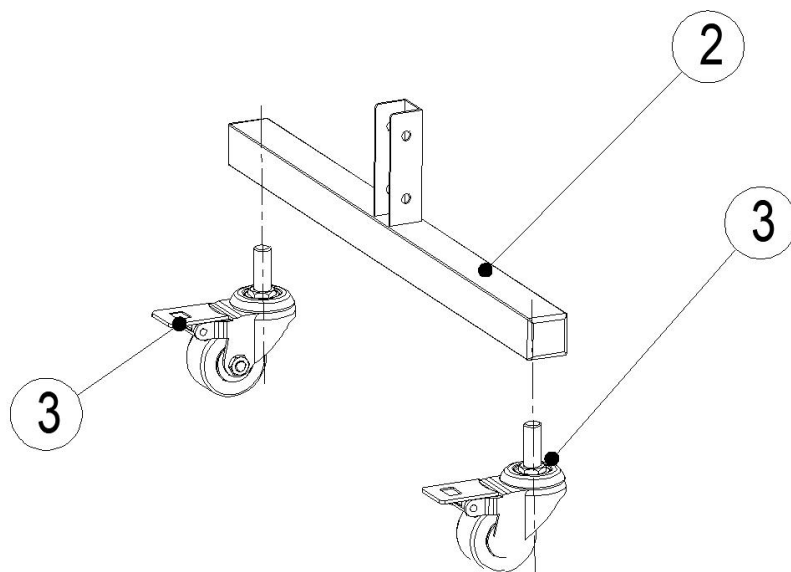
X3



2

					
1	X 1	4	X 6	5	X 6

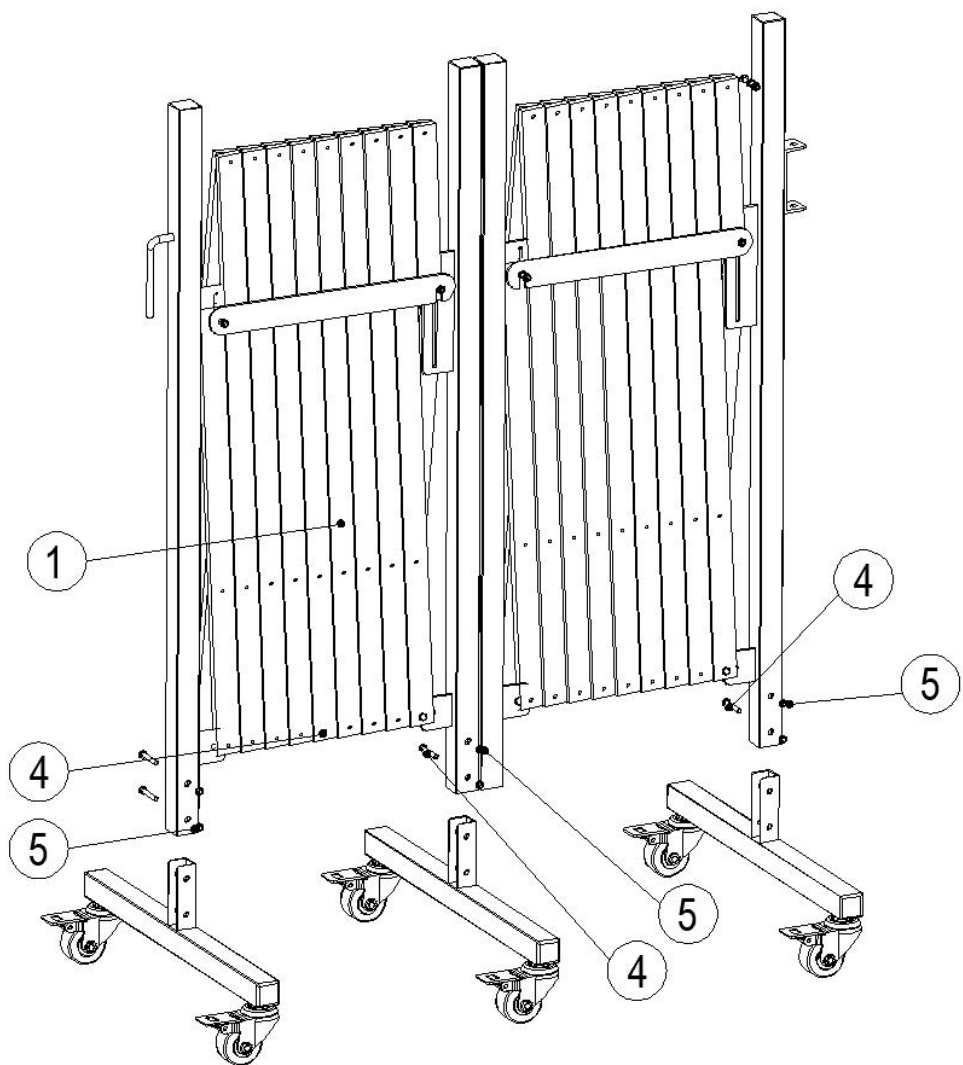

3

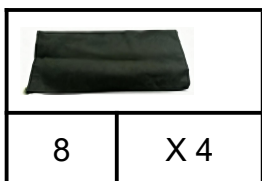

8

X 4



■ Note

When fully expanded, fill the sandbags with sand and place them on the crossbars at both ends to enhance stability.

PRODUCT PARAMETER

Modèle	XSJ-S-0008	XSJ-S-0009
---------------	------------	------------

Couleur	Blanc	Brun
Matériel	Acier au carbone + alliage d' aluminium	Acier au carbone + alliage d' aluminium

Fabricant : Shanghaimuxinmuyeyouxiangongsi

Adresse : Shuangchenglu 803nong11hao1602A-1609shi, baoshanqu, Shanghai 200000 CN.

Importé en Australie : SIHAO PTY LTD. 1 ROKEVA
STREETEASTWOOD
NSW 2122 Australie

Importé aux États-Unis : Sanven Technology Ltd., Suite 250, 9166
Anaheim
Rancho Cucamonga, CA 91730

EC	REP
-----------	------------

E-CrossStu GmbH
Mainzer Landstr.69,60329 Frankfurt am Main.
e-crossstu@outlook.com Tel: +49 69332967674

UK	REP
-----------	------------

YH CONSULTING LIMITED. C/O YH Consulting
Limited Office 147, Centurion House, London
Road, Staines-upon-Thames, Surrey, TW18 4AX
H2YHUK@gmail.com Tel.: +44 07514-677868



VEVOR

Upgrade · The Home Creator Way

Uitbreidbare metalen barricade

MODEL: XSJ-S-0008/XSJ-S-0009

MODEL: XSJ-S-0008/XSJ-S-0009

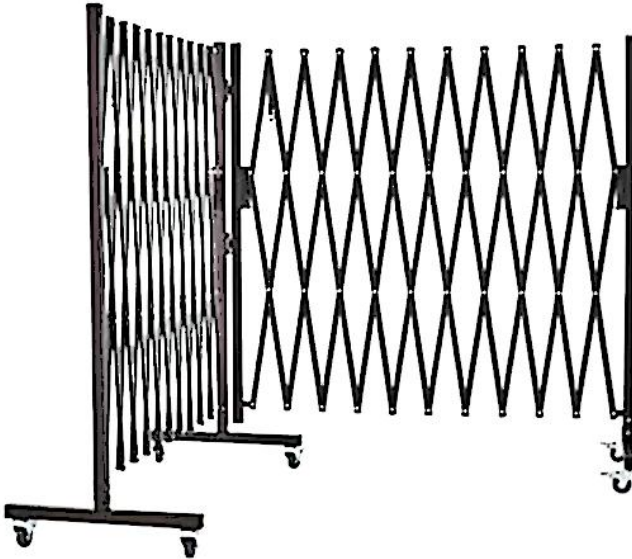

Video-installatie QR-code

Dit is de originele handleiding. Lees alle instructies zorgvuldig door voordat u het product gebruikt. VEVOR behoudt zich het recht voor om de gebruiksaanwijzing duidelijk te interpreteren. Het uiterlijk van het product is afhankelijk van het product dat u hebt ontvangen. Neemt u het ons niet kwalijk dat we u niet meer op de hoogte stellen van eventuele

technologische of software-updates voor ons product.

SAFETY INSTRUCTIONS

WAARSCHUWING:

Lees dit materiaal voordat u dit product gebruikt. Het niet naleven hiervan kan ernstig letsel tot gevolg hebben.

Voorzorgsmaatregelen voor montage

25. Monteer uitsluitend volgens deze instructies. Onjuiste montage kan gevaarlijk zijn.
26. Draag tijdens de montage een ANSI-goedgekeurde veiligheidsbril en stevige werkhandschoenen.
27. Houd de verzamelplaats schoon en goed verlicht.
28. Houd omstanders tijdens de montage uit de buurt.
29. Kom niet in actie als u moe bent of onder invloed van alcohol, drugs of medicijnen.
30. De producteigenschappen gelden uitsluitend voor correct en volledig gemonteerde producten.
31. Raadpleeg voor meer informatie over de onderdelen die op de volgende pagina's worden vermeld het montageschema in deze handleiding. Pak alle onderdelen uit en scheid ze van elkaar op een schone werkplek.
32. Het gebruik van een elektrische schroevendraaier kan de efficiëntie van de productinstallatie effectief verbeteren. De productaccessoires omvatten zandzakken, die de stabiliteit van het product effectief kunnen verbeteren.







Gebruik voorzorgsmaatregelen

16. NIET OP DIT ITEM ZITTEN OF STAAN.
17. Dit product is geen speelgoed. Laat kinderen niet met of in de buurt van dit artikel spelen.
18. Niet overschrijden aangegeven gewichtscapaciteiten.
19. Alleen gebruiken zoals bedoeld.
20. Controleer het product voor elk gebruik. Niet gebruiken als er

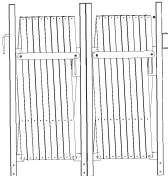
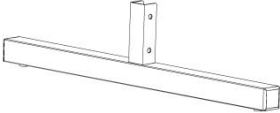
onderdelen loszitten of beschadigd zijn.

BEWAAR DEZE HANDLEIDING

PARTS LIST

Artikelnr.	Afbeelding	Aantal
1		× 1
2		× 3
3		× 6
4		× 6
5		× 6
6		× 1
7		× 1

8		× 4
---	-----------------------------------------------------------------------------------	-----

EXPLODED VIEW

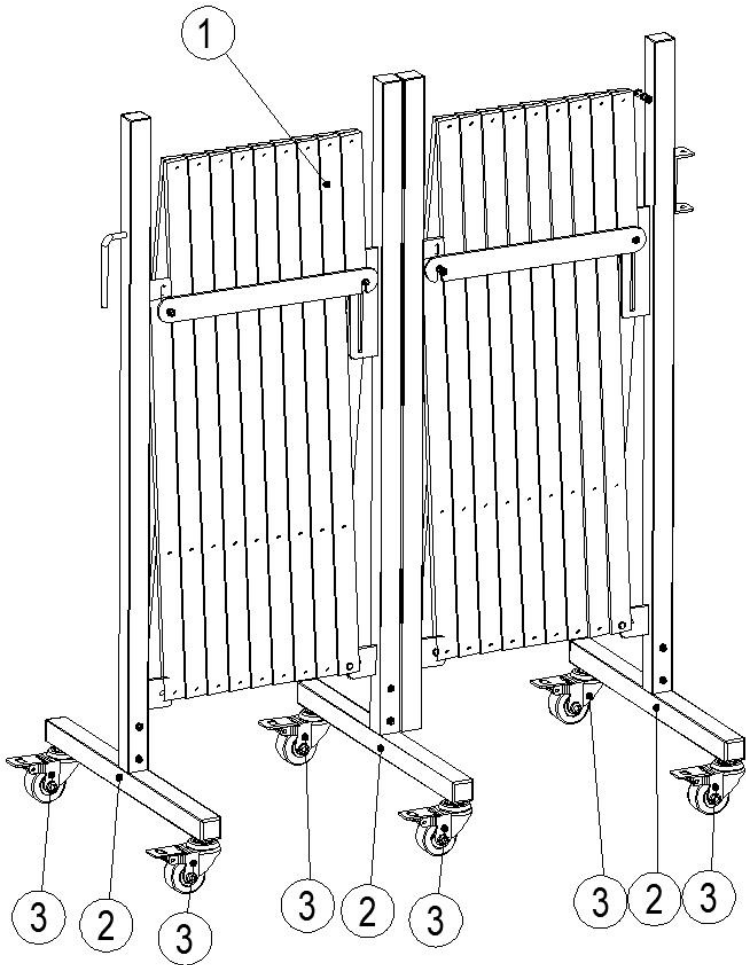



TOOLS



ASSEMBLY

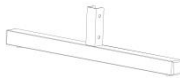

1

	
2	X3
3	X6

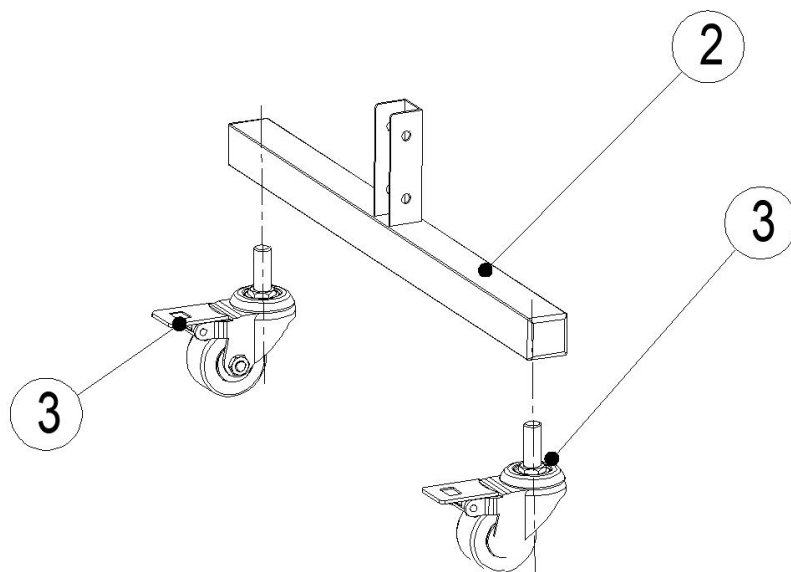
X3



2

					
1	X1	4	X6	5	X6

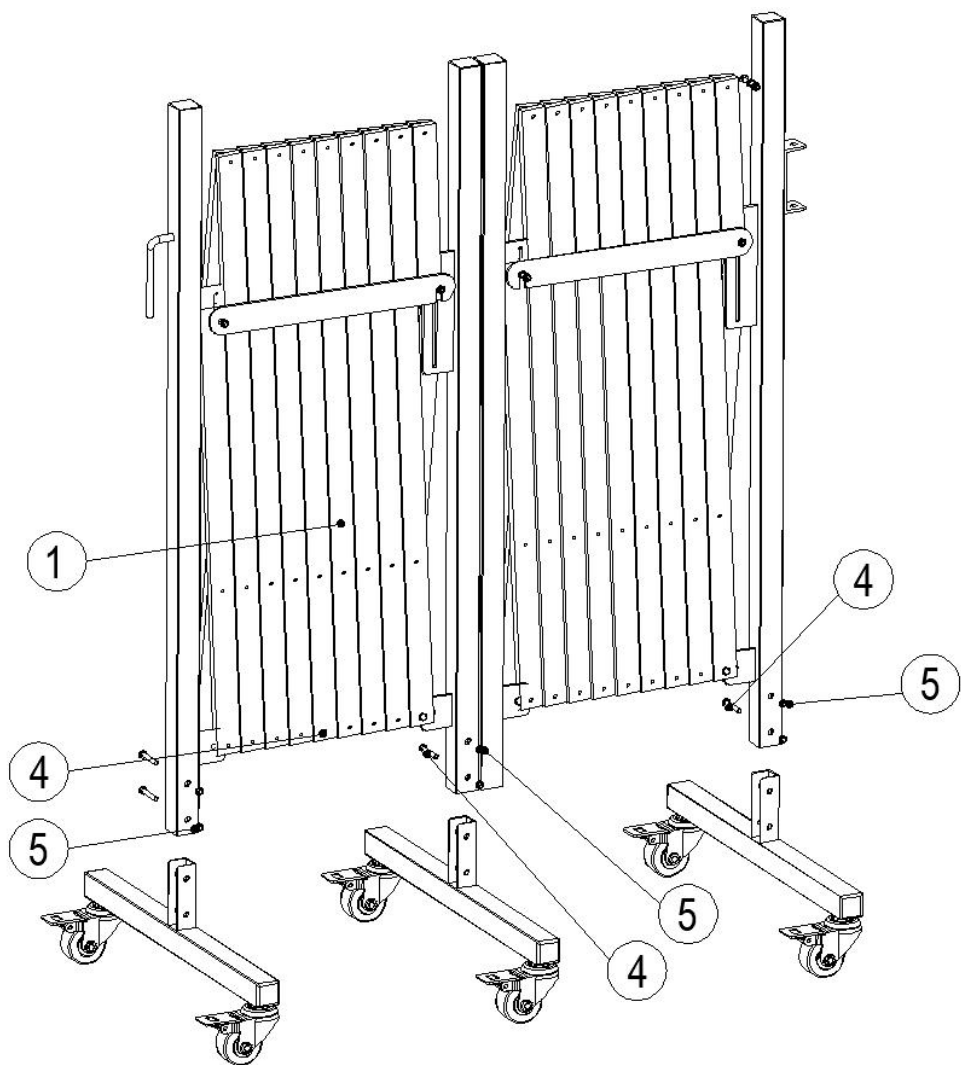

3

	
8	X4



■ Note

When fully expanded, fill the sandbags with sand and place them on the crossbars at both ends to enhance stability.

PRODUCT PARAMETER

Model	XSJ-S-0008	XSJ-S-0009
--------------	------------	------------

Kleur	Wit	Bruin
Materiaal	Koolstofstaal + Een aluminiumlegering	Koolstofstaal + Een aluminiumlegering

Fabrikant: Shanghai muxinmuyeyouxiangongsi

Adres: Shuangchenglu 803nong11hao1602A-1609shi, baoshanqu, shanghai 200000 CN.

Geïmporteerd naar AUS: SIHAO PTY LTD. 1 ROKEVA
STREETEASTWOOD
NSW 2122 Australië

Geïmporteerd naar de VS: Sanven Technology Ltd. Suite 250, 9166
Anaheim
Plaats, Rancho Cucamonga, CA 91730

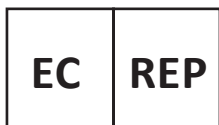

E-CrossStu GmbH
Mainzer Landstr.69,60329 Frankfurt am Main.
e-crossstu@outlook.com Tel: +49 69332967674



YH CONSULTING LIMITED. C/O YH Consulting
Limited Office 147, Centurion House, London
Road, Staines-upon-Thames, Surrey, TW18 4AX
H2YHUK@gmail.com Tel.: +44 07514-677868



VEVOR

Upgrade · The Home Creator Way

Expanderbar metallbarrikad

MODELL: XSJ-S-0008/XSJ-S-0009

MODELL: XSJ-S-0008/XSJ-S-0009

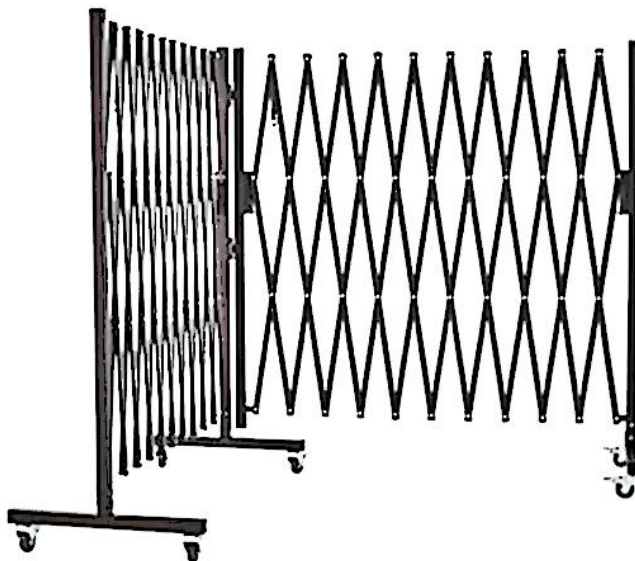

QR-kod för videoinstallation

Detta är originalinstruktionerna, vänligen läs alla instruktioner noggrant innan du använder produkten. VEVOR förbehåller sig en tydlig tolkning av vår användarmanual. Produktens utseende ska vara beroende av den produkt du mottagit. Vi ber om ursäkt för att vi inte kommer att informera dig igen om det finns några teknik- eller programuppdateringar för vår

produkt.

SAFETY INSTRUCTIONS

WARNING:

Läs detta material innan du använder produkten. Underlåtenhet att göra det kan leda till allvarliga skador.

Monteringsförsiktighetsåtgärder







33. Montera endast enligt dessa instruktioner. Felaktig montering kan skapa risker.
34. Använd ANSI-godkända skyddsglasögon och kraftiga arbetshandskar under monteringen.
35. Håll samlingsområdet rent och väl upplyst.
36. Håll åskådare borta från området under monteringen.
37. Montera inte om du är trött eller påverkad av alkohol, droger eller mediciner.
38. Produktens egenskaper gäller endast korrekt och fullständigt monterade produkter.
39. För ytterligare information om delarna som listas på följande sidor, se monteringsdiagrammet i denna manual. Packa upp och separera alla delar på en ren arbetsyta.
40. Att använda en elektrisk skruvmejsel kan effektivt förbättra produktens installationseffektivitet. Produkttillbehören inkluderar sandsäckar, vilket effektivt kan förbättra produktens stabilitet.

Använd försiktighetsåtgärder

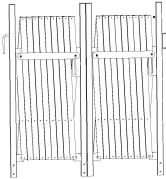
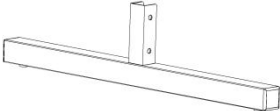
21. SITTA ELLER STÅ INTE PÅ DENNA FÖRENING.
22. Denna produkt är inte en leksak. Låt inte barn leka med eller i närheten av denna produkt.
23. Överskrid inte angivna viktkapacitet.
24. Använd endast som avsett.
25. Kontrollera före varje användning; använd inte om delar är lösa eller skadade.

SPARA DENNA HANDBOK

PARTS LIST

Artikelnummer	Bild	Antal
1		× 1
2		× 3
3		× 6
4		× 6
5		× 6
6		× 1
7		× 1

8		× 4
---	-----------------------------------------------------------------------------------	-----

EXPLODED VIEW

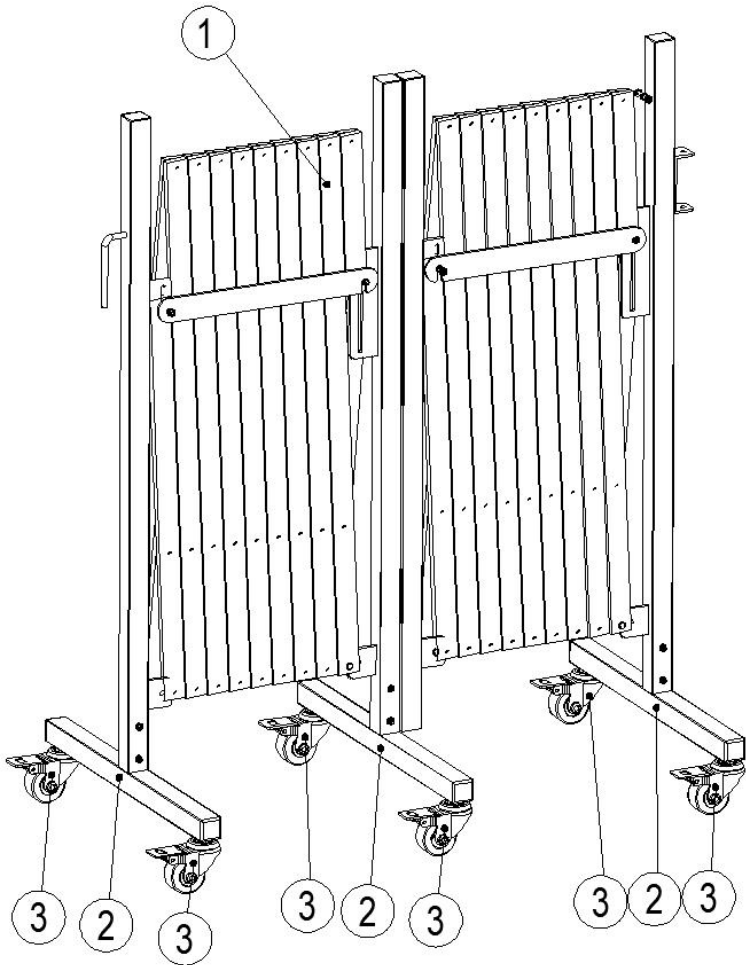



TOOLS



ASSEMBLY



1

			
2	3 st	3	X 6

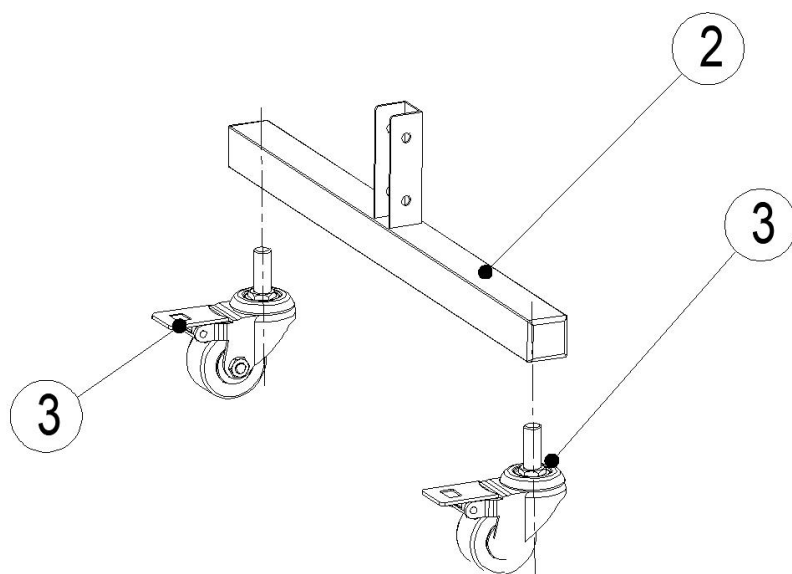
X3



2

					
1	1 st	4	X 6	5	X 6

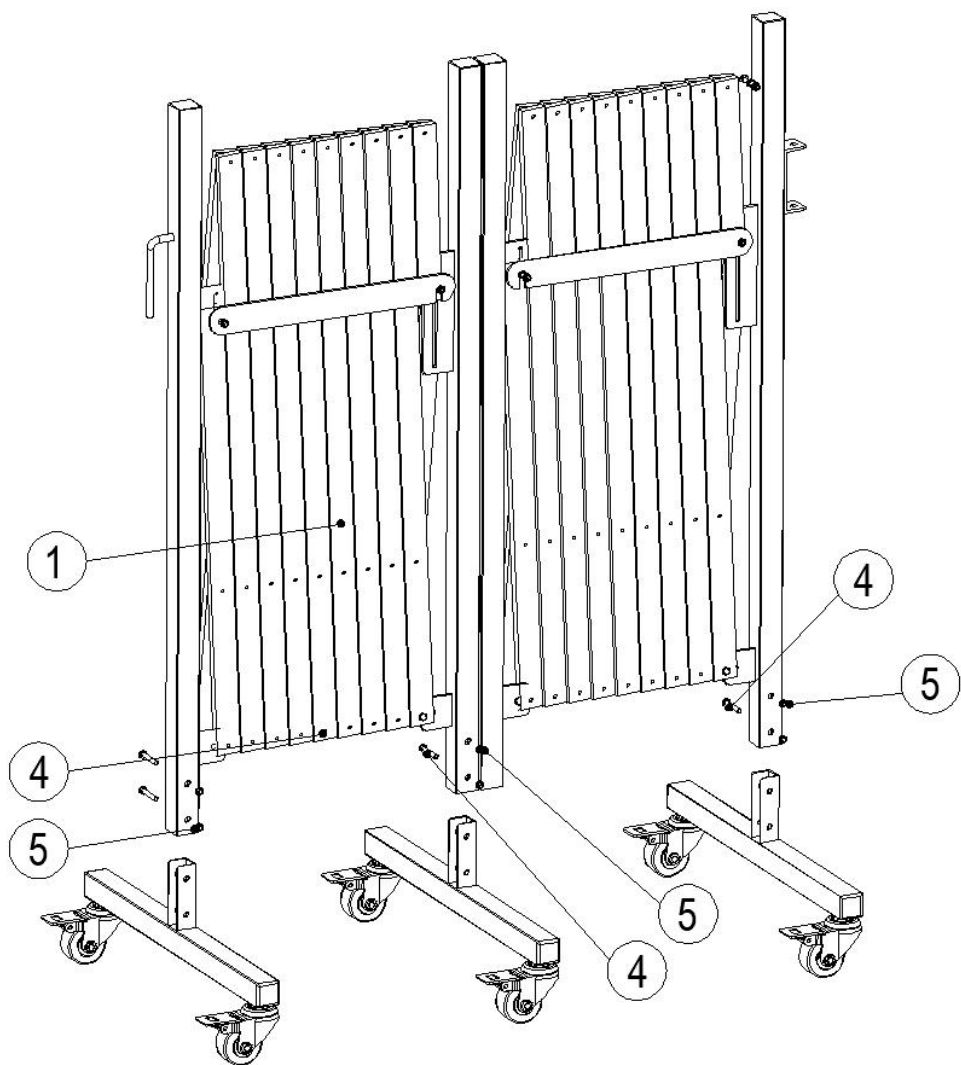

3

	
8	4 st



■ Note

When fully expanded, fill the sandbags with sand and place them on the crossbars at both ends to enhance stability.

PRODUCT PARAMETER

Modell	XSJ-S-0008	XSJ-S-0009
---------------	------------	------------

Färg	Vit	Brun
Material	Kolstål + En aluminiumlegering	Kolstål + En aluminiumlegering

Tillverkare: Shanghaimuxinmuyeyouxiangongsi

Adress: Shuangchenglu 803nong11hao1602A-1609shi, baoshanqu, Shanghai 200 000 kanadensiska republiken.

Importerad till Australien: SIHAO PTY LTD. 1 ROKEVA
STREETEASTWOOD
NSW 2122 Australien

Importerad till USA: Sanven Technology Ltd. Suite 250, 9166 Anaheim Plats, Rancho Cucamonga, Kalifornien 91730

EC	REP
-----------	------------

E-CrossStu GmbH
Mainzer Landstr.69,60329 Frankfurt am Main.
e-crossstu@outlook.com Tel: +49 69332967674

UK	REP
-----------	------------

YH CONSULTING LIMITED. C/O YH Consulting
Limited Office 147, Centurion House, London
Road, Staines-upon-Thames, Surrey, TW18 4AX
H2YHUK@gmail.com Tel.: +44 07514-677868



VEVOR

Upgrade · The Home Creator Way

Barricada metálica expandible

MODELO: XSJ-S-0008/XSJ-S-0009

MODELO: XSJ-S-0008/XSJ-S-0009

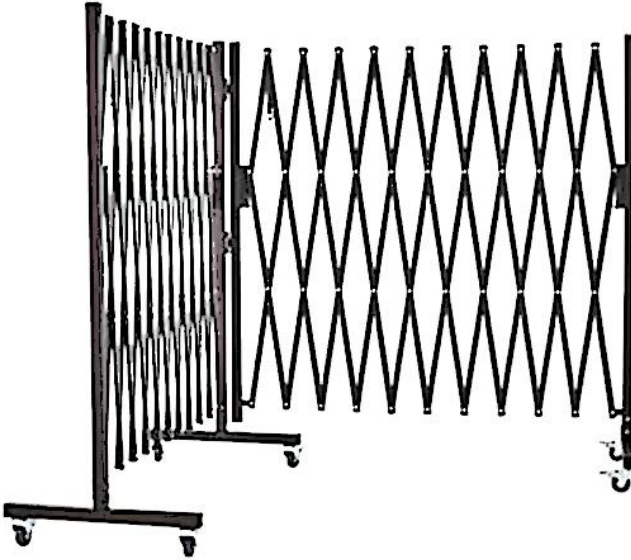

Código QR de instalación de vídeo

Estas son las instrucciones originales; lea atentamente todas las instrucciones del manual antes de utilizarlo. VEVOR se reserva el derecho de interpretar su manual de usuario. La apariencia del producto dependerá del producto que haya recibido. Le rogamos que nos disculpe si no le informamos de nuevo si hay actualizaciones tecnológicas o de software en

nuestro producto.

SAFETY INSTRUCTIONS

ADVERTENCIA:

Lea este material antes de usar este producto. De lo contrario, podría sufrir lesiones graves.

Precauciones de montaje







41. Ensamble únicamente según estas instrucciones. Un montaje incorrecto puede causar peligros.
42. Use gafas de seguridad aprobadas por ANSI y guantes de trabajo resistentes durante el montaje.
43. Mantenga el área de reunión limpia y bien iluminada.
44. Mantenga a los transeúntes fuera del área durante el montaje.
45. No se reúna si está cansado o bajo la influencia del alcohol, drogas o medicamentos.
46. Las capacidades del producto se aplican únicamente a productos ensamblados de forma correcta y completa.
47. Para obtener más información sobre las piezas que se enumeran en las siguientes páginas, consulte el diagrama de montaje de este manual. Desembale y separe todas las piezas en un área de trabajo limpia.
48. El uso de un destornillador eléctrico puede mejorar eficazmente la eficiencia de instalación del producto. Los accesorios incluyen sacos de arena que mejoran eficazmente la estabilidad del producto.

Tome precauciones

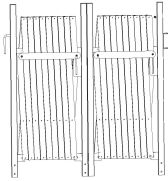
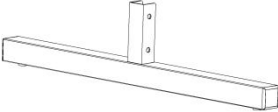
26. NO SE SIENTA NI SE PARE SOBRE ESTE ARTÍCULO.
27. Este producto no es un juguete. No permita que los niños jueguen con él ni cerca de él.
28. No exceda lo especificado capacidades de peso.
29. Úselo únicamente según lo previsto.
30. Inspeccione antes de cada uso; no lo utilice si las piezas están sueltas o dañadas.

GUARDE ESTE MANUAL

PARTS LIST

N.º de artículo	Imagen	Cantidad
1		× 1
2		× 3
3		× 6
4		× 6
5		× 6
6		× 1
7		× 1

8		× 4
---	-----------------------------------------------------------------------------------	-----

EXPLODED VIEW

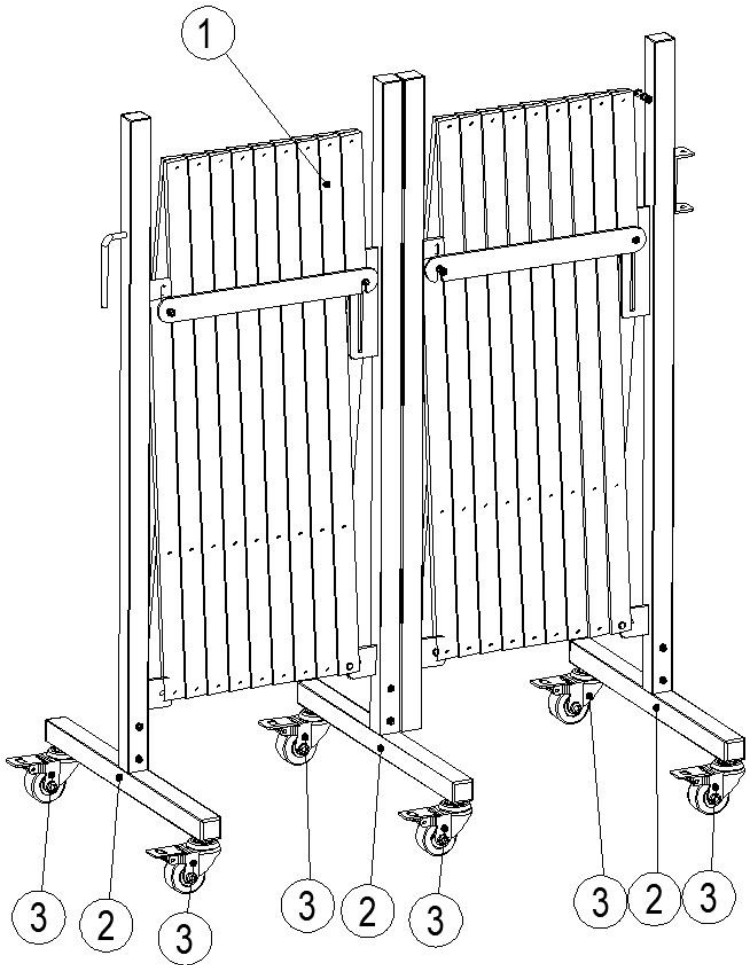

TOOLS



ASSEMBLY



1

2	X 3	3	X 6

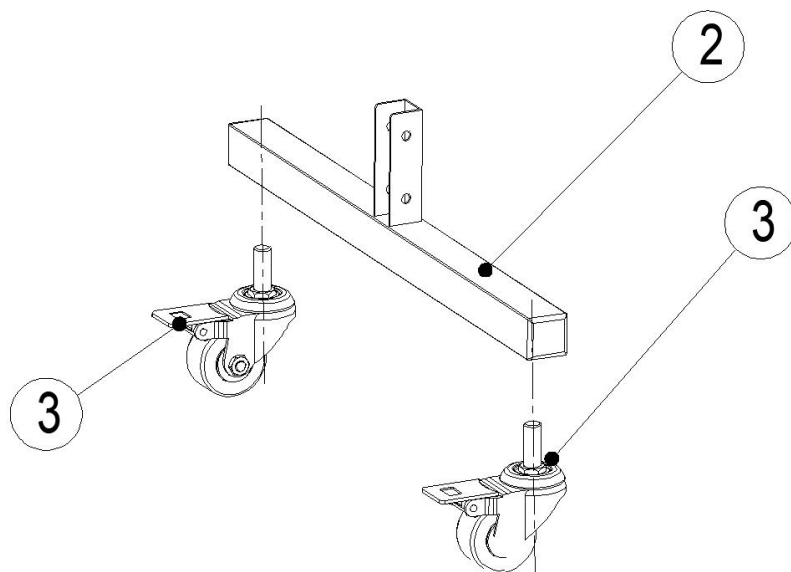
X3



2

					
1	X 1	4	X 6	5	X 6

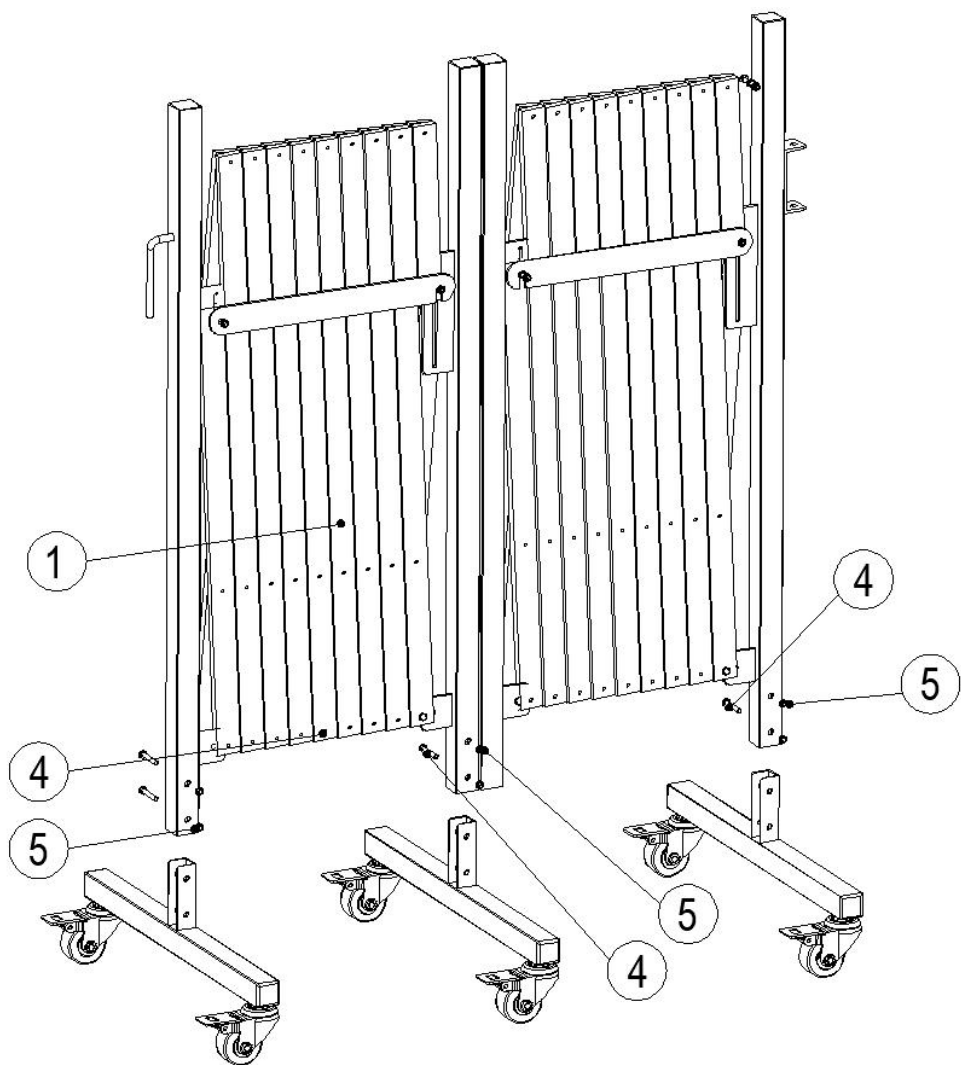

3

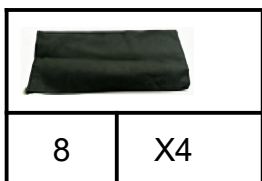

8

X4



■ Note

When fully expanded, fill the sandbags with sand and place them on the crossbars at both ends to enhance stability.

PRODUCT PARAMETER

Modelo	XSJ-S-0008	XSJ-S-0009
---------------	------------	------------

Color	Blanco	Marrón
Material	carbono + Una aleación de aluminio.	carbono + Una aleación de aluminio.

Fabricante: Shanghaimuxinmuyeyouxiangongsi

Dirección: Shuangchenglu 803nong11hao1602A-1609shi, baoshanqu, Shanghái 200000 CN.

Importado a AUS: SIHAO PTY LTD. 1 ROKEVA STREET EASTWOOD NSW 2122 Australia

Importado a EE. UU.: Sanven Technology Ltd. Suite 250, 9166 Anaheim Lugar, Rancho Cucamonga, CA 91730

EC	REP
-----------	------------

E-CrossStu GmbH
 Mainzer Landstr.69,60329 Frankfurt am Main.
 e-crossstu@outlook.com Tel: +49 69332967674

UK	REP
-----------	------------

YH CONSULTING LIMITED. C/O YH Consulting
 Limited Office 147, Centurion House, London
 Road, Staines-upon-Thames, Surrey, TW18 4AX
 H2YHUK@gmail.com Tel.: +44 07514-677868



VEVOR

Upgrade · The Home Creator Way

Barricata metallica espandibile

MODELLO: XSJ-S-0008/XSJ-S-0009

MODELLO: XSJ-S-0008/XSJ-S-0009

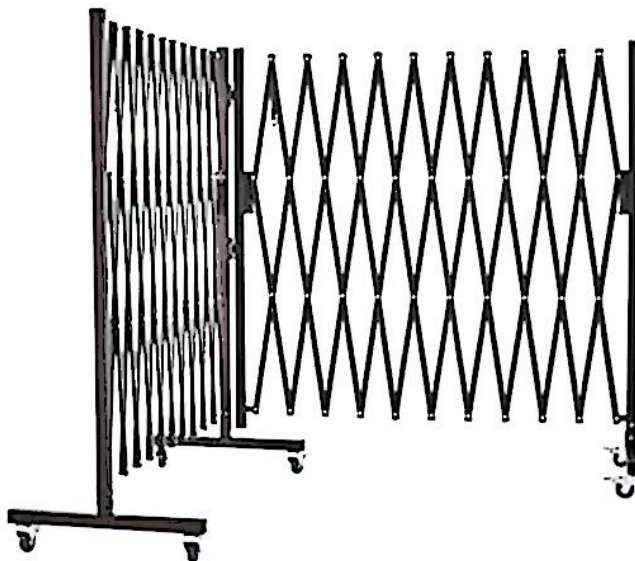

Codice QR per l'installazione video

Queste sono le istruzioni originali, si prega di leggere attentamente tutte le istruzioni del manuale prima dell'uso. VEVOR si riserva la piena interpretazione del proprio manuale utente. L'aspetto del prodotto dipenderà dal prodotto ricevuto. Vi preghiamo di non informarvi più in caso di aggiornamenti tecnologici o software sul nostro prodotto.

SAFETY INSTRUCTIONS

AVVERTIMENTO:

Leggere attentamente questo materiale prima di utilizzare il prodotto. La mancata osservanza di questa indicazione può causare gravi lesioni.







Precauzioni di montaggio

49. Montare solo secondo queste istruzioni. Un montaggio improprio può comportare pericoli.
50. Durante il montaggio, indossare occhiali di sicurezza omologati ANSI e guanti da lavoro resistenti.
51. Mantenere l'area di assemblaggio pulita e ben illuminata.
52. Durante l'assemblea, tenere gli astanti lontani dall'area.
53. Non montare se si è stanchi o sotto l'effetto di alcol, droghe o medicinali.
54. Le capacità del prodotto si applicano solo ai prodotti correttamente e completamente assemblati.
55. Per ulteriori informazioni sui componenti elencati nelle pagine seguenti, fare riferimento allo schema di montaggio di questo manuale. Disimballare e separare tutti i componenti in un'area di lavoro pulita.
56. L'utilizzo di un cacciavite elettrico può migliorare notevolmente l'efficienza dell'installazione del prodotto. Gli accessori includono sacchi di sabbia, che possono migliorare efficacemente la stabilità del prodotto.

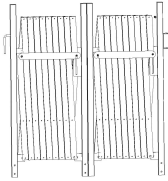
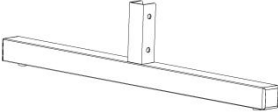
Precauzioni d'uso

31. **NON SEDERSI O STARE IN PIEDI SU QUESTO OGGETTO.**
32. Questo prodotto non è un giocattolo. Non permettere ai bambini di giocare con questo articolo o nelle sue vicinanze.
33. Non superare i valori specificati capacità di peso.
34. Utilizzare solo come previsto.
35. Ispezionare prima di ogni utilizzo; non utilizzare se alcune parti sono allentate o danneggiate.

CONSERVARE QUESTO MANUALE**PARTS LIST**

Articolo n.	Immagine	Quantità
1		× 1
2		× 3
3		× 6
4		× 6
5		× 6
6		× 1
7		× 1

8		× 4
---	-----------------------------------------------------------------------------------	-----

EXPLODED VIEW

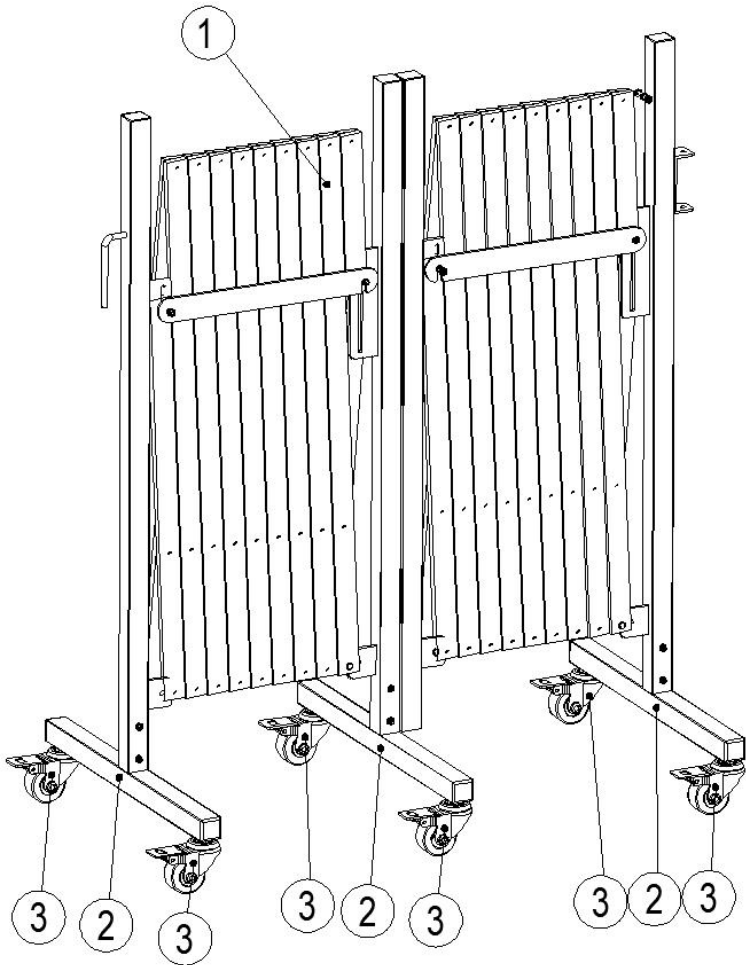

TOOLS



ASSEMBLY



1

2	X 3	3	X 6

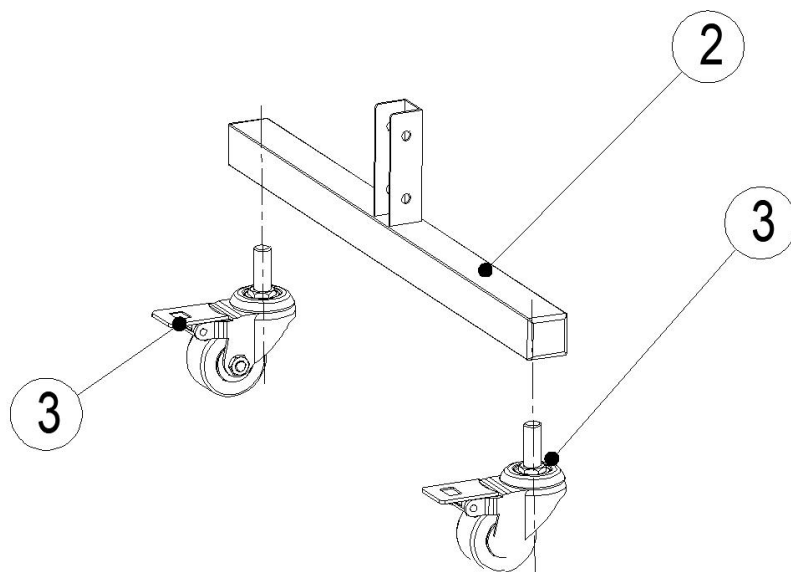
X3



2

					
1	X 1	4	X 6	5	X 6

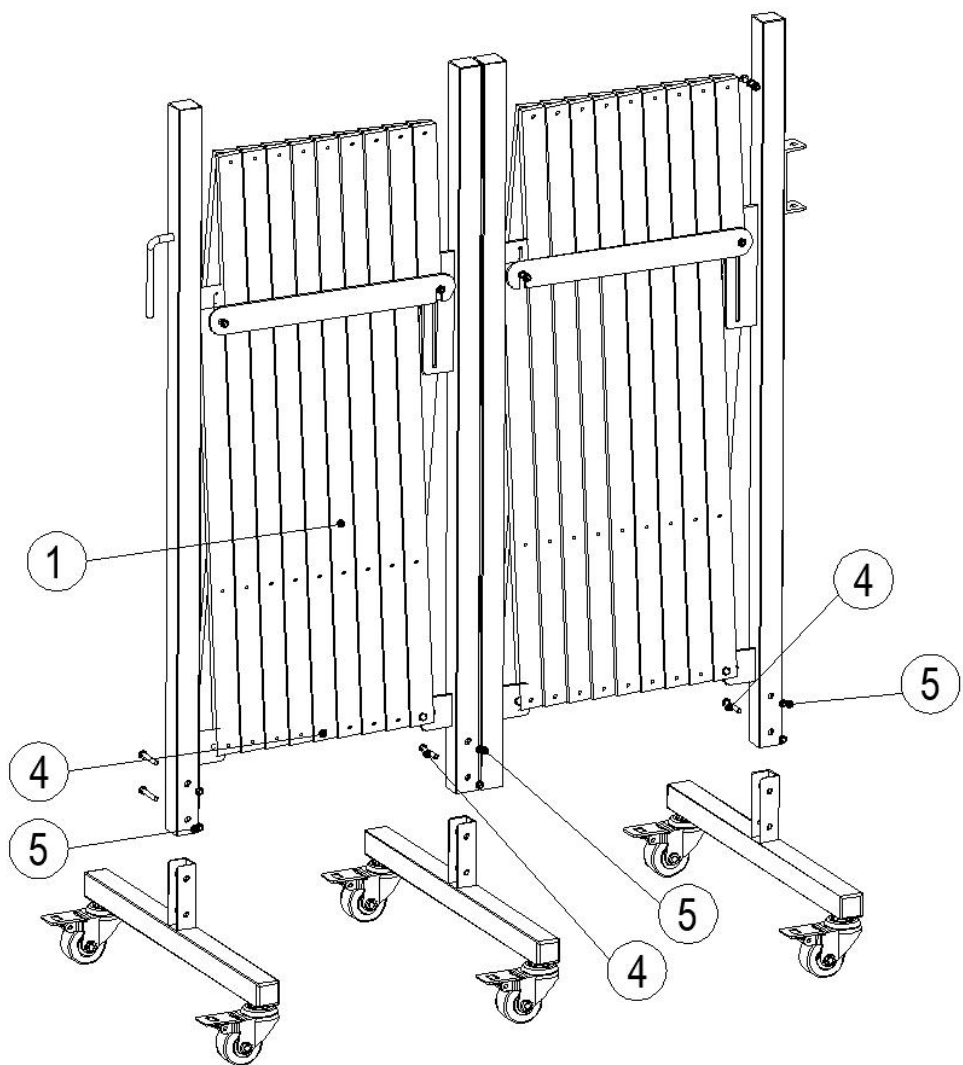

3

	
8	X 4



Note

When fully expanded, fill the sandbags with sand and place them on the crossbars at both ends to enhance stability.

PRODUCT PARAMETER

Modello	XSJ-S-0008	XSJ-S-0009
----------------	------------	------------

Colore	Bianco	Marrone
Materiale	al carbonio + lega di alluminio	al carbonio + lega di alluminio

Produttore: Shanghaimuxinmuyeyouxiangongsi

Indirizzo: Shuangchenglu 803nong11hao1602A-1609shi, baoshanqu, Shanghai 200000 CN.

Importato in AUS: SIHAO PTY LTD. 1 ROKEVA STREETEASTWOOD Nuovo Galles del Sud 2122 Australia

Importato negli USA: Sanven Technology Ltd. Suite 250, 9166 Anaheim Luogo, Rancho Cucamonga, CA 91730

EC	REP
-----------	------------

E-CrossStu GmbH
 Mainzer Landstr.69,60329 Frankfurt am Main.
 e-crossstu@outlook.com Tel: +49 69332967674

UK	REP
-----------	------------

YH CONSULTING LIMITED. C/O YH Consulting Limited Office 147, Centurion House, London Road, Staines-upon-Thames, Surrey, TW18 4AX
 H2YHUK@gmail.com Tel.: +44 07514-677868



VEVOR

Upgrade · The Home Creator Way

Rozszerzalna metalowa barykada

MODEL: XSJ-S-0008/XSJ-S-0009

MODEL: XSJ-S-0008/XSJ-S-0009

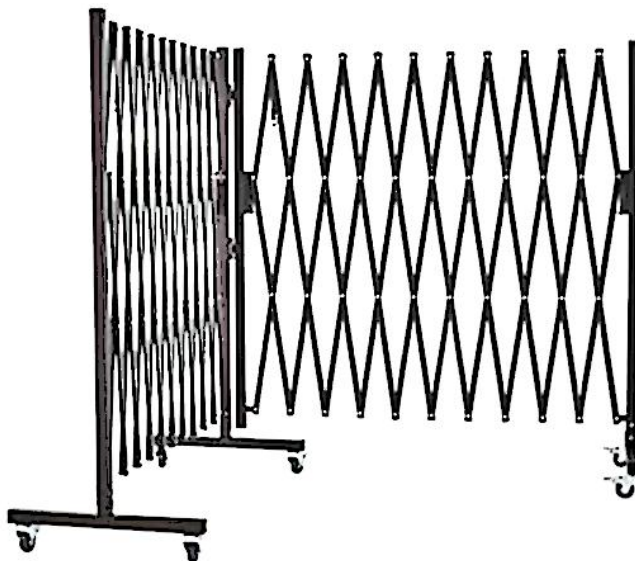

Kod QR instalacji wideo

To jest oryginalna instrukcja obsługi. Przed użyciem prosimy o dokładne zapoznanie się z treścią instrukcji. Firma VEVOR zastrzega sobie prawo do jednoznacznej interpretacji niniejszej instrukcji obsługi. Wygląd produktu zależy od stanu, w jakim go otrzymali Państwo. Prosimy o wyrozumiałość, ale nie będziemy Państwa ponownie informować o

aktualizacjach technologicznych lub oprogramowania naszego produktu.

SAFETY INSTRUCTIONS

OSTRZEŻENIE:

Przeczytaj ten materiał przed użyciem produktu. Nieprzestrzeganie tego zalecenia może spowodować poważne obrażenia.

Środki ostrożności podczas montażu

57. Montaż należy wykonywać wyłącznie zgodnie z niniejszą instrukcją. Nieprawidłowy montaż może stwarzać zagrożenie.
58. Podczas montażu należy nosić okulary ochronne zatwierdzone przez ANSI oraz wytrzymałe rękawice robocze.
59. Utrzymuj miejsce zgromadzenia w czystości i zapewnij dobre oświetlenie.
60. Nie dopuszczaj osób postronnych na teren montażu w trakcie jego trwania.
61. Nie przychodź na zgromadzenie, jeśli jesteś zmęczony lub pod wpływem alkoholu, narkotyków lub leków.
62. Możliwości produktu odnoszą się wyłącznie do produktów prawidłowo i całkowicie zmontowanych.
63. Aby uzyskać dodatkowe informacje dotyczące części wymienionych na kolejnych stronach, zapoznaj się ze schematem montażu w niniejszej instrukcji. Rozpakuj i oddziel wszystkie części w czystym miejscu pracy.
64. Użycie wkrętarki elektrycznej może skutecznie zwiększyć wydajność montażu produktu. Akcesoria obejmują worki z piaskiem, które skutecznie zwiększają stabilność produktu.





Zachowaj środki ostrożności

36. NIE WOLNO SIEDZIEĆ ANI STAWAĆ NA TYM PRZEDMIOCIE.
37. Ten produkt nie jest zabawką. Nie pozwalaj dzieciom bawić się nim ani przebywać w jego pobliżu.
38. Nie przekraczać określonej wartości nośności.
39. Stosować wyłącznie zgodnie z przeznaczeniem.

40. Przed każdym użyciem należy przeprowadzić kontrolę. Nie używać produktu, jeśli części są luźne lub uszkodzone.

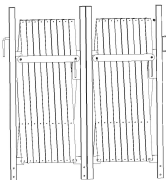
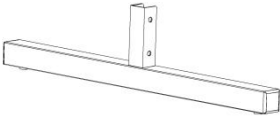
ZAPISZ TĘ INSTRUKCJĘ

PARTS LIST

Numer pozycji	Obraz	Ilość
1		× 1
2		× 3
3		× 6
4		× 6
5		× 6
6		× 1

7		× 1
8		× 4

EXPLODED VIEW

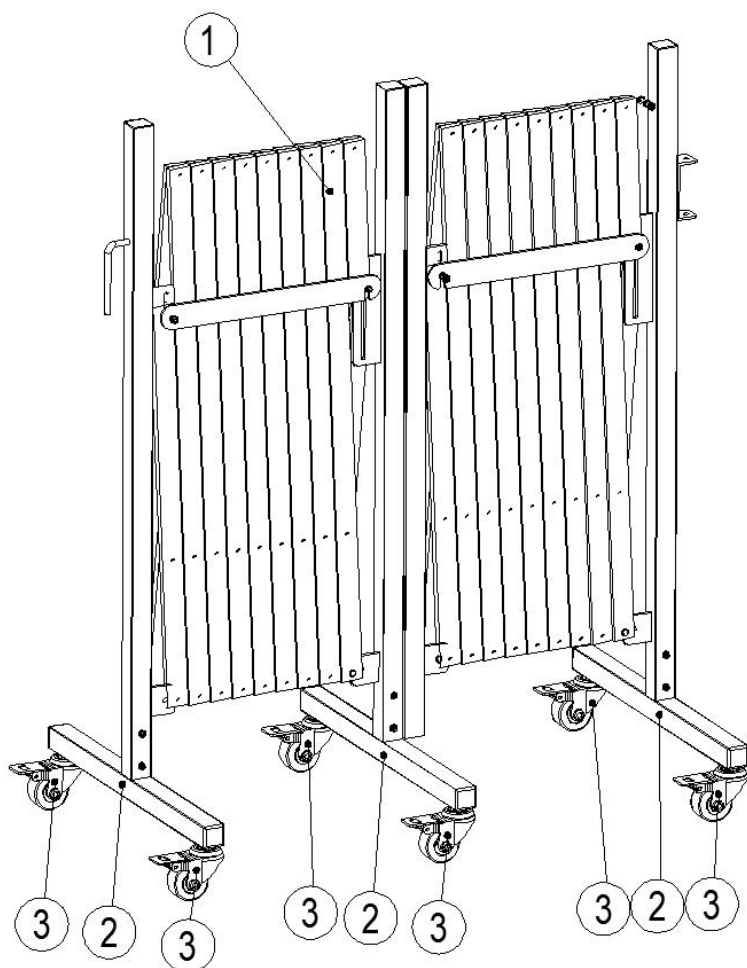

TOOLS



ASSEMBLY



1

2	X3	3	X6

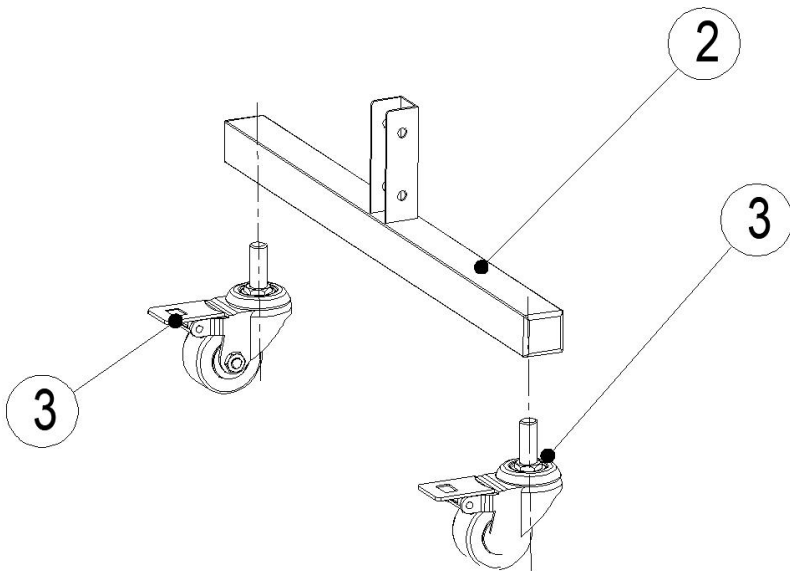
X3



2

					
1	X 1	4	X 6	5	X 6

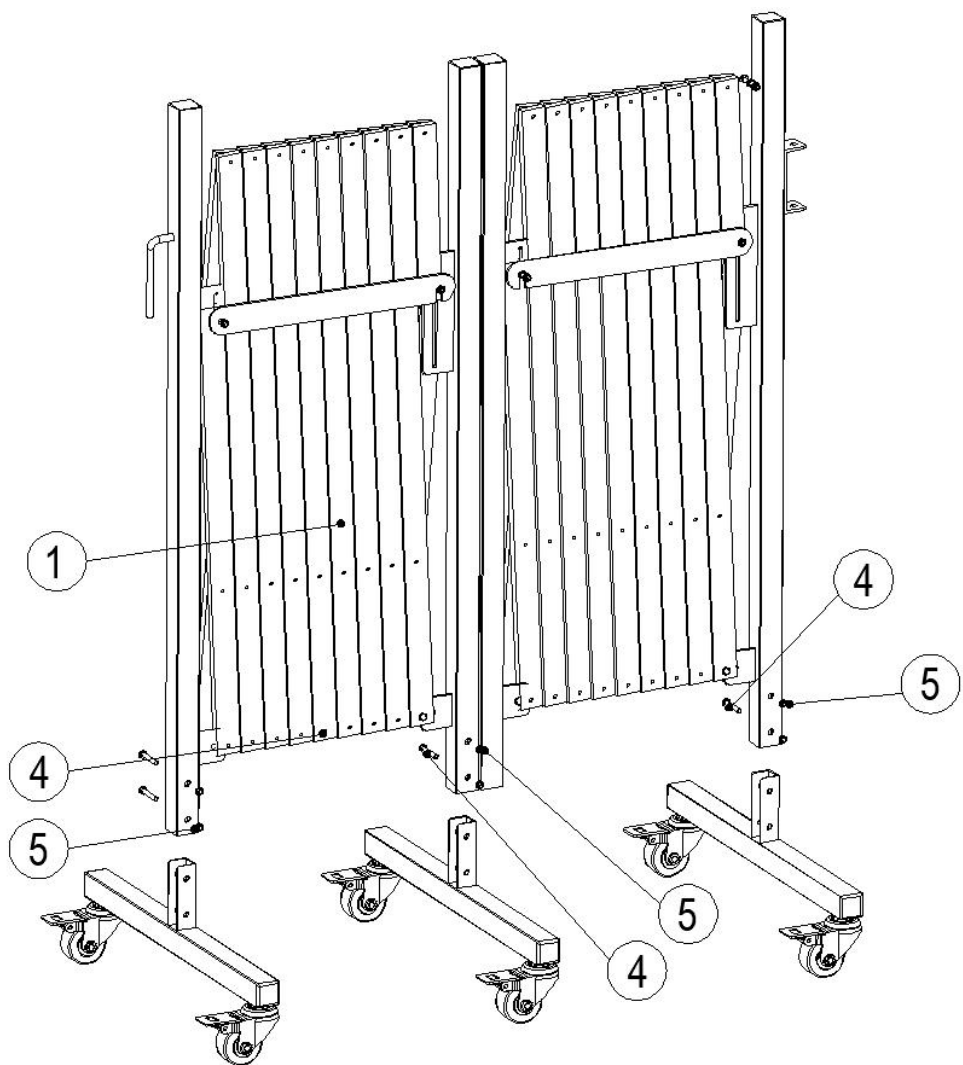

3

8	X 4



Note

When fully expanded, fill the sandbags with sand and place them on the crossbars at both ends to enhance stability.

PRODUCT PARAMETER

Model	XSJ-S-0008	XSJ-S-0009
--------------	------------	------------

Kolor	Biały	Brązowy
Tworzywo	węglowa + stop aluminium	węglowa + stop aluminium

Producent: Shanghaimuxinmuyeyouxiangongsi

Adres: Shuangchenglu 803nong11hao1602A-1609shi, baoshanqu, szanghaj 200000 CN.

Importowane do AUS: SIHAO PTY LTD. 1 ROKEVA
STRETEASTWOOD

NSW 2122 Australia

Importowane do USA: Sanven Technology Ltd. Suite 250, 9166 Anaheim
Miejsce, Rancho Cucamonga, CA 91730

EC	REP
-----------	------------

E-CrossStu GmbH

Mainzer Landstr.69,60329 Frankfurt am Main.

e-crossstu@outlook.com Tel: +49 69332967674

UK	REP
-----------	------------

YH CONSULTING LIMITED. C/O YH Consulting

Limited Office 147, Centurion House, London
Road, Staines-upon-Thames, Surrey, TW18 4AX

H2YHUK@gmail.com Tel.: +44 07514-677868

